

PROGRAMMA ACCESSORI
ACCESSORIES PROGRAM
PROGRAMME DU ACCESSOIRES
ZUBEHÖR PROGRAMM
PROGRAMA ACESORIOS
ЛИНИЯ АКЦЕССУАРОВ
ΠΡΟΓΡΑΜΜΑ ΕΞΑΡΤΗΜΑΤΩΝ
浴室产品配件

RETTANGOLO

*Accessori - Accessories - Accessoires- Zubehör
Accesorios - Аксессуары - Εξαρτήματα - 配件*

GESSI 

Gessi SpA - Parco Gessi

13037 Serravalle Sesia (Vercelli) - Italy

Phone +39 0163 454111 - Facsimile +39 0163 459273

www.gessi.com - gessi@gessi.it



Art. 20804

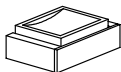

Art. 20801
 Art. 20802

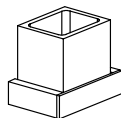

Art. 20807
 Art. 20808

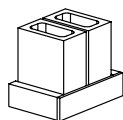

Art. 20810
 Art. 20811

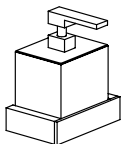

Art. 20813
 Art. 20814

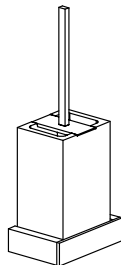

Art. 20819
 Art. 20820

Fig. 1

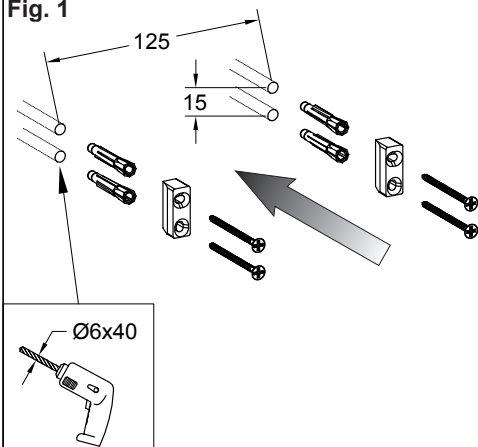

Fig. 2

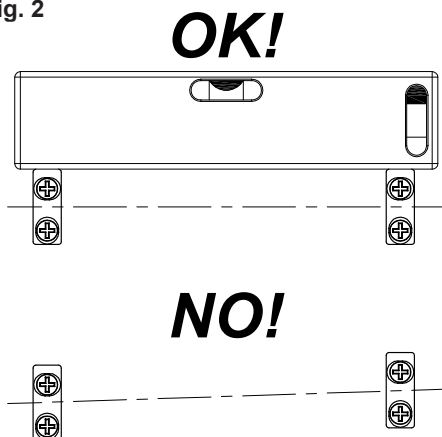

Fig. 3

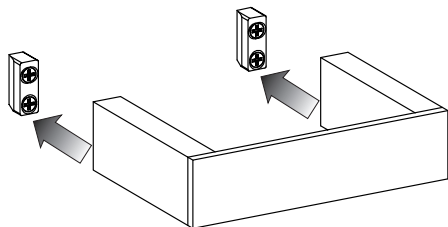
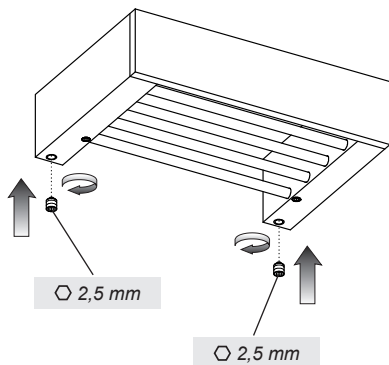
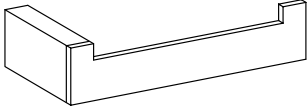
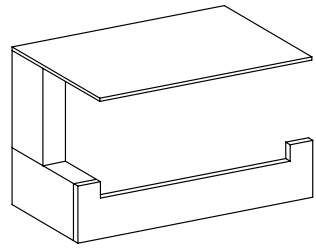

Fig. 4





Art. 20855



Art. 20849

Fig. 1

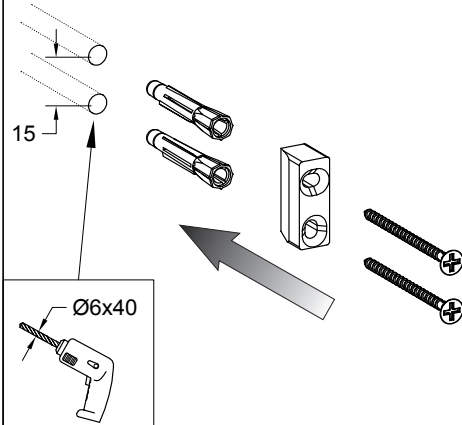

Fig. 2

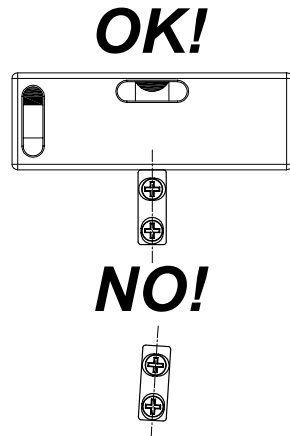

Fig. 3

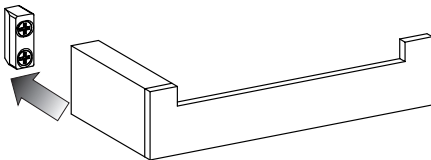
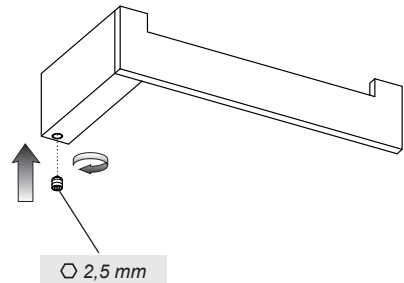
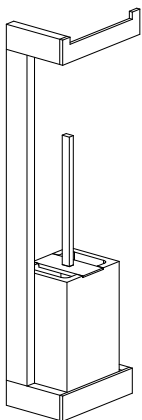

Fig. 4





Art. 20867
Art. 20868

Fig. 1

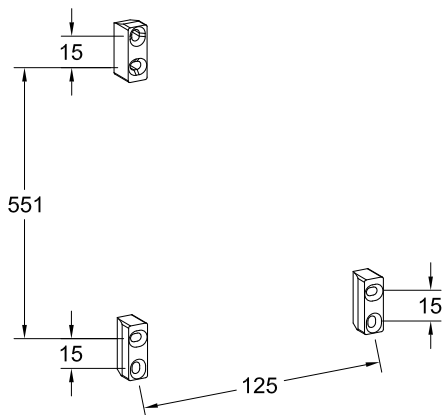

Fig. 2

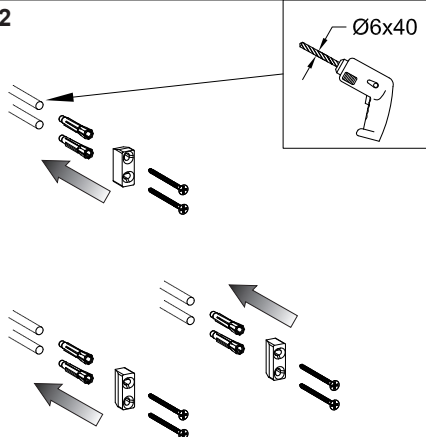

Fig. 3

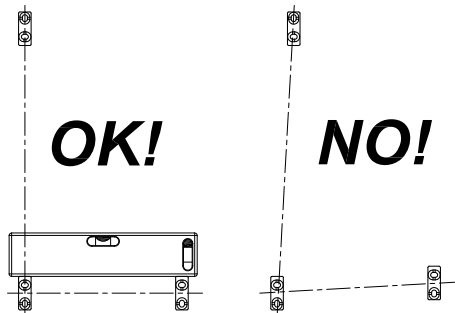
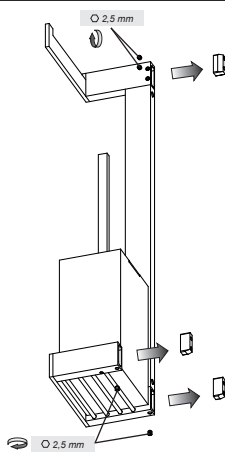
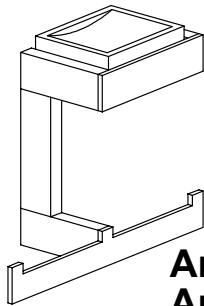
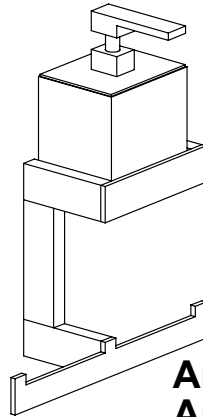

Fig. 4





Art. 20873
Art. 20874



Art. 20879
Art. 20880

Fig. 1

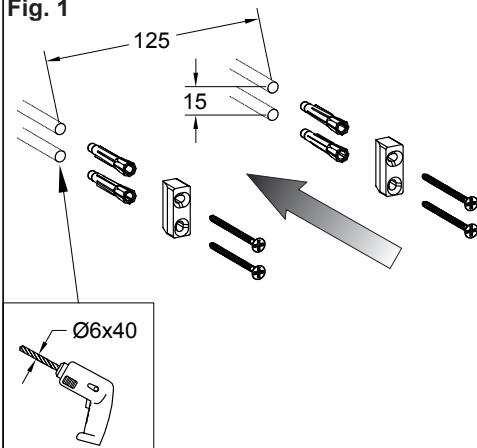

Fig. 2

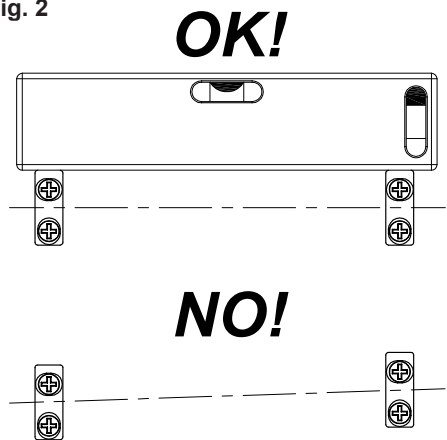

Fig. 3

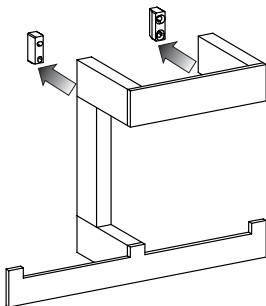

Fig. 4

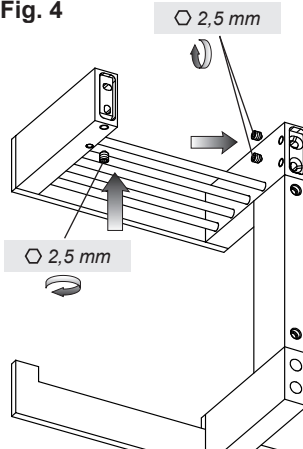
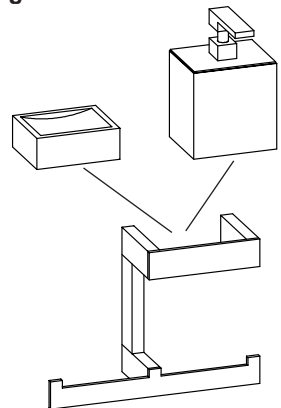

Fig. 5



Art. 20897



Art. 20900

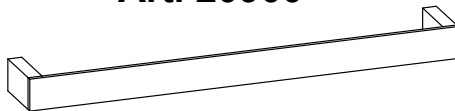

Art. 20903

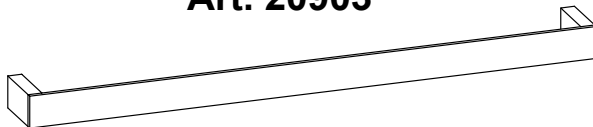

Fig. 1

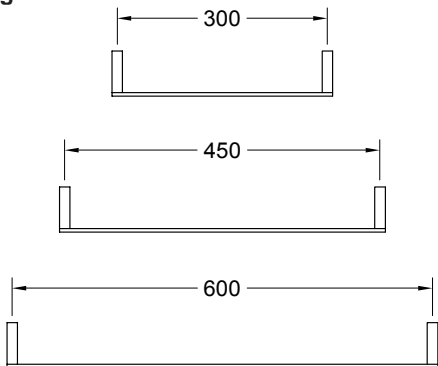

Fig. 2

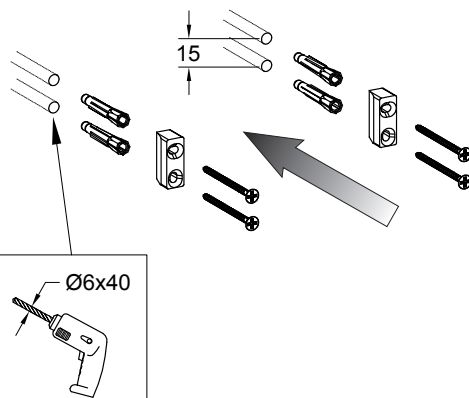

Fig. 3

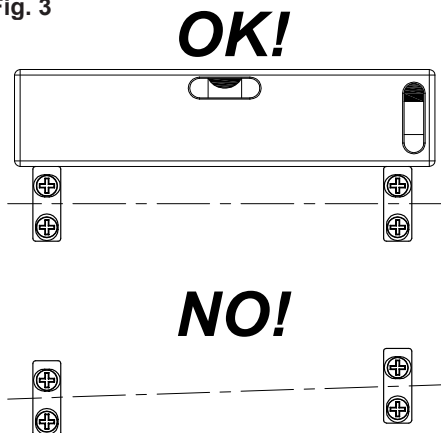
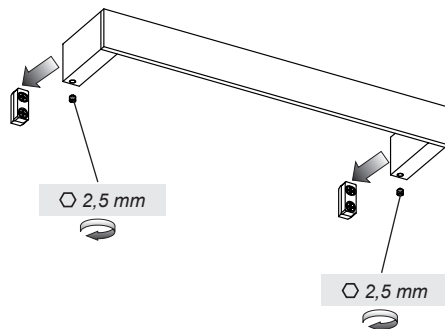
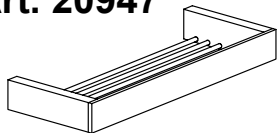

Fig. 4



Art. 20947



Art. 20949

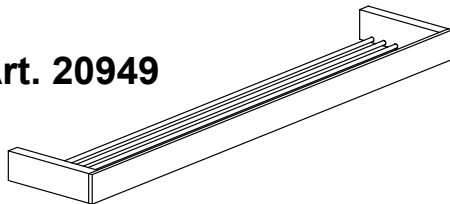

Art. 20945

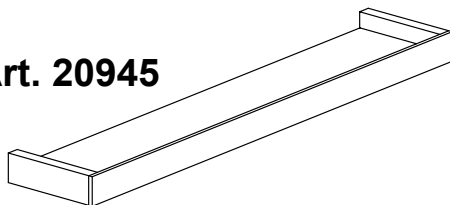

Fig. 1

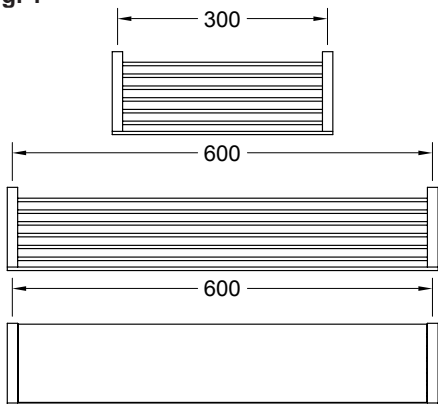

Fig. 2

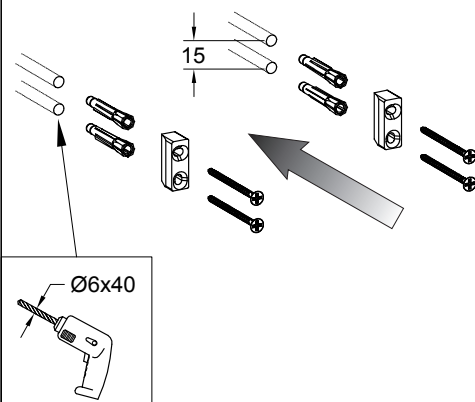

Fig. 3

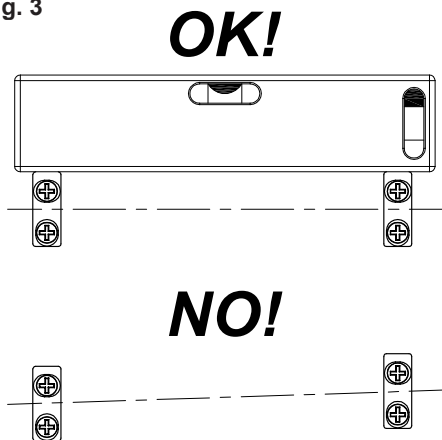
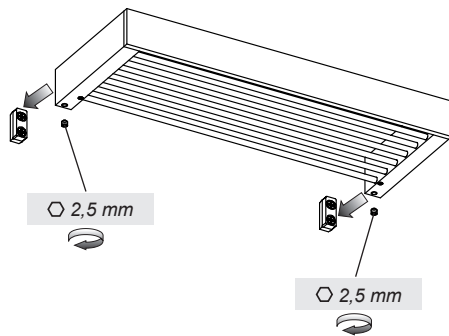

Fig. 4



Art. 20950

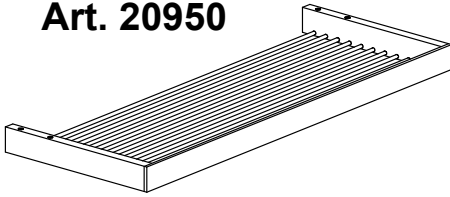

Fig. 1

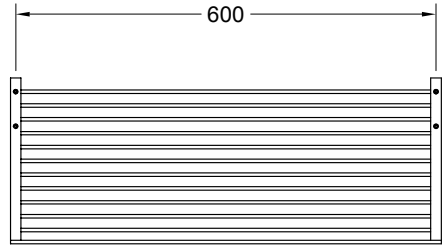

Fig. 2

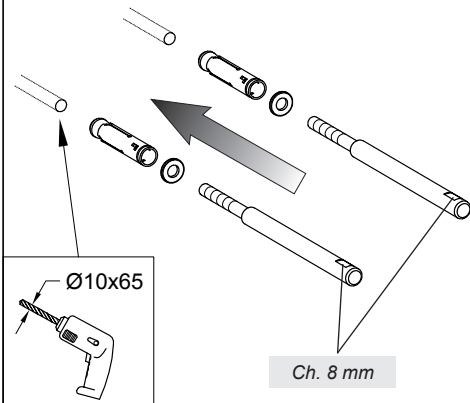

Fig. 3

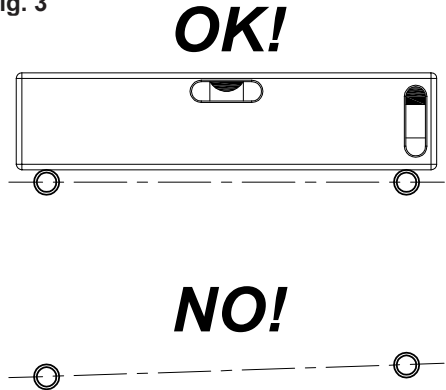

Fig. 4

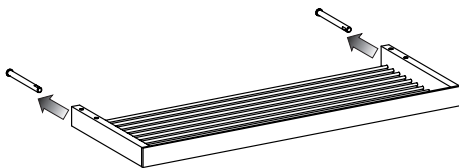
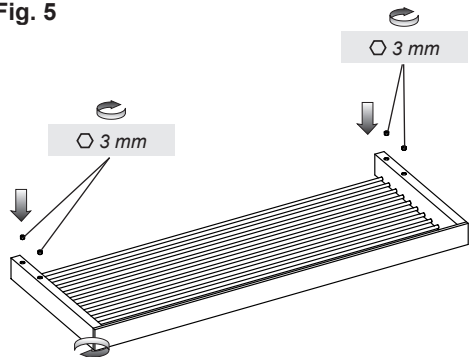
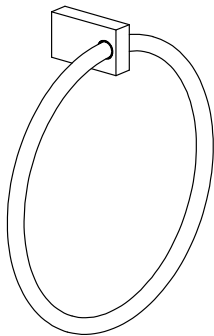
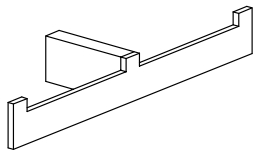

Fig. 5





Art. 20909



Art. 20915



Art. 20921

Fig. 1

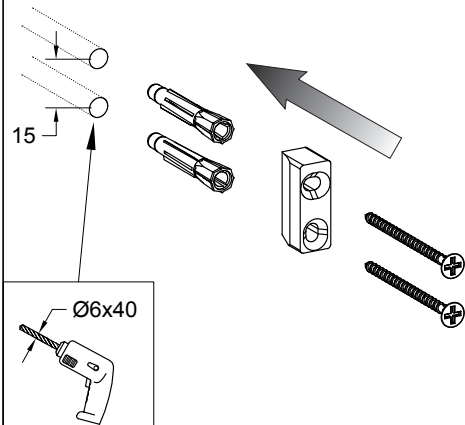

Fig. 2

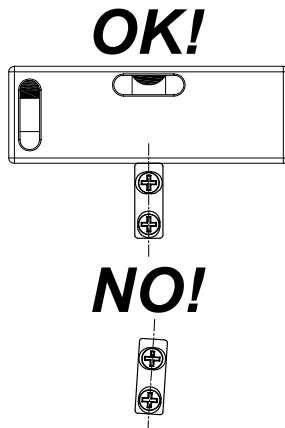

Fig. 3

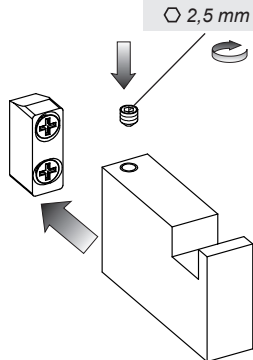
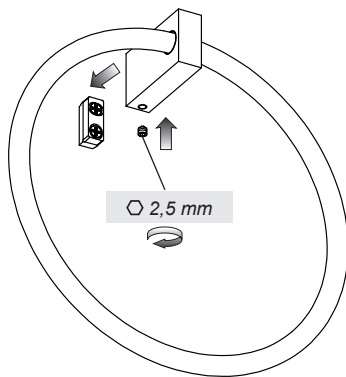
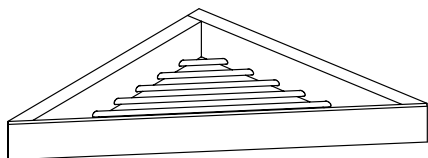

Fig. 4





Art. 20861

Fig. 1

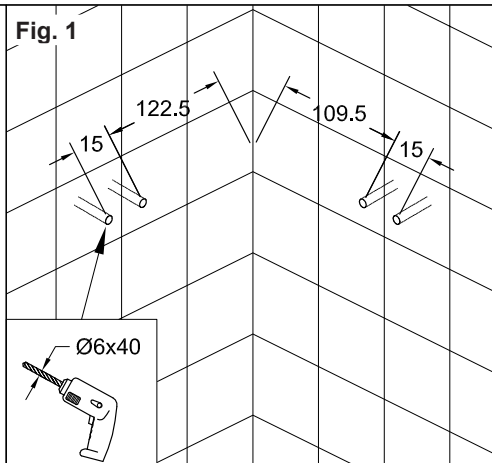
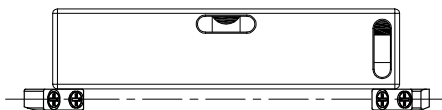

Fig. 2



Fig. 3

OK!



NO!

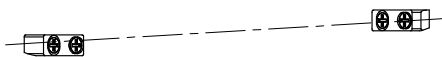

Fig. 4

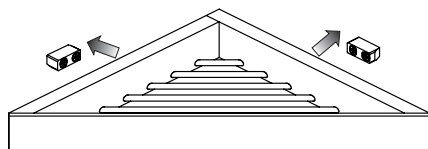
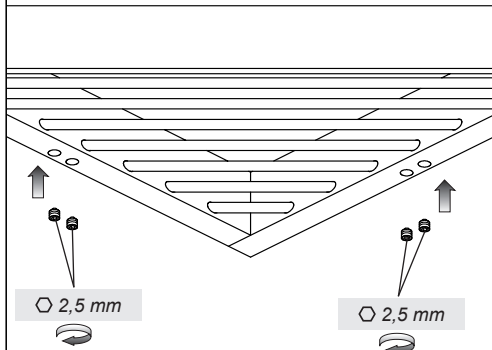
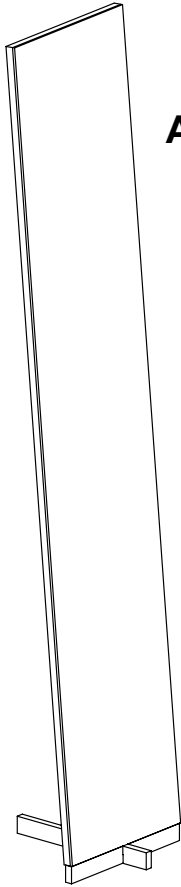

Fig. 5





Art. 20987

Fig. 1

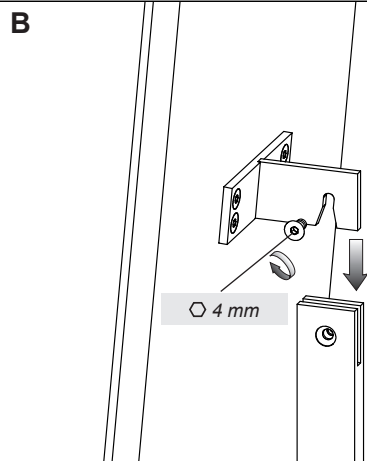
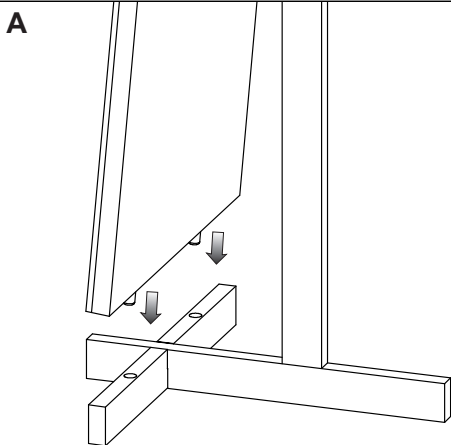
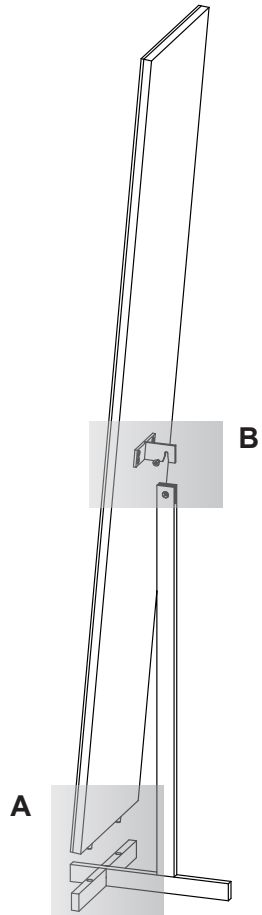

Fig. 1

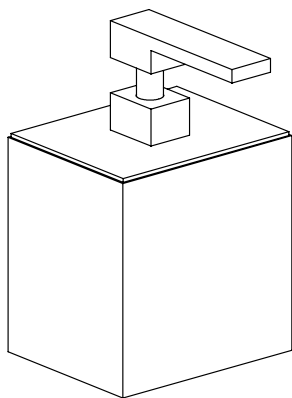

Fig. 2

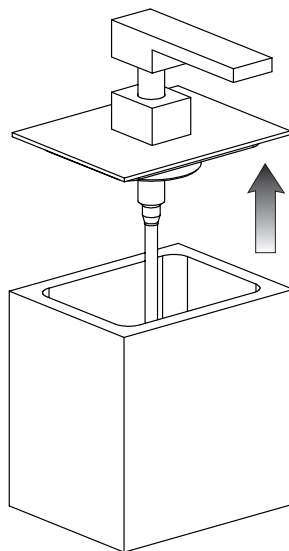

Fig. 3

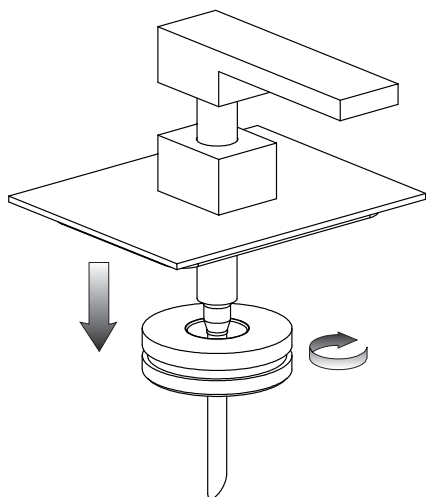

Fig. 4

