

MISCELLANEOUS

R97755





















Scarico universale. / Pop-up waste.



Scarico universale. Chiusura a pressione.

Pop-up waste, with push system.

Finiture / Finishes

 C8 Cromo / Chrome	 C3 Nickel Spazzolato / Brushed Nickel	 C8 Nickel Lucido / Polished Nickel	 C40 Oro / Gold	 C41 Oro spazzolato / Brushed Gold	 C50 Metal Black / Metal Black	 C51 Metal Black spazzolato / Brushed Metal Black
 W1 Bianco Opaco Goffrato / Embossed Matt White	 N1 Nero Opaco Goffrato / Embossed Matt Black	 N6 Nero opaco / Matt black	 L5 Blu mediterraneo / Mediterranean blu	 P21 PVD brushed chocolate / PVD brushed chocolate	 P31 Brushed PVD British gold / Brushed PVD British gold	 P41 PVD Oro Spazzolato / PVD Brushed Gold
 P81 Brushed total black PVD / Brushed total black PVD	 P91 Brushed PVD Copper / Brushed PVD Copper	 J3 Glossy gesso / Glossy gesso	 K7 Pearl cipria / Pearl cipria	 R6 Pearl chili / Pearl chili	 V7 Pearl salvia / Pearl salvia	 V8 Matt mirto / Matt mirto

MISCELLANEOUS

R97755

Disegno Complessivo / Overall Drawing

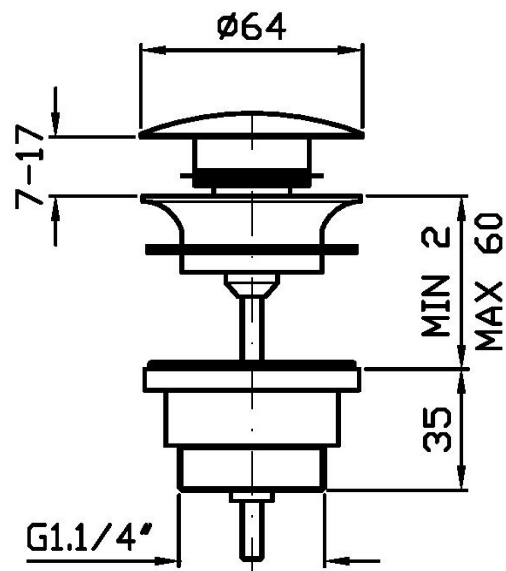

Note / Notes

MISCELLANEOUS

R97755

Pesi e Misure / Weights and Sizes

Peso (Kg) Weight (lb)	0,36 (Kg)	0,79 (lb)
Volume test (dc3) - (in3)	0,47 (dc3)	28,68 (in3)
h (mm) - (in)	94,00 (mm)	3,70 (in)
L1 (mm) - (in)	71,00 (mm)	2,80 (in)
L2 (mm) - (in)	71,00 (mm)	2,80 (in)

