

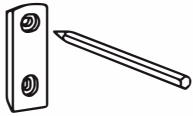

1.

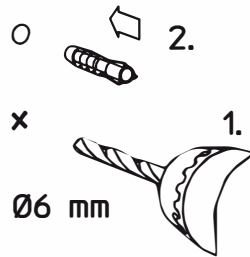

2.

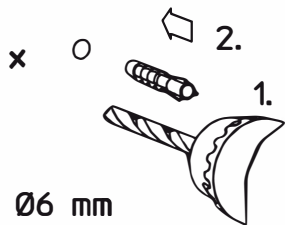
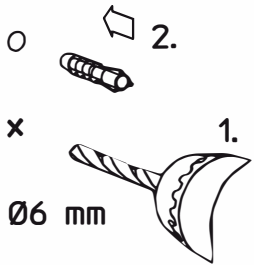

3.

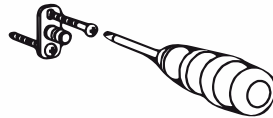
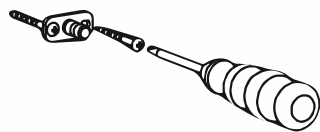

4.

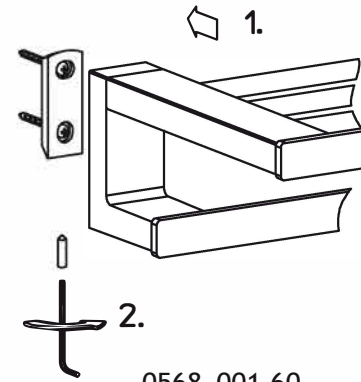

0568 001 60

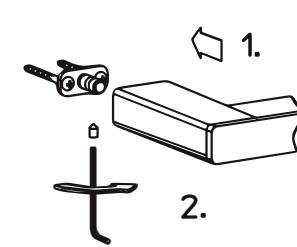

0550 001 42  
0550 001 32  
0561 001 60  
0561 001 80

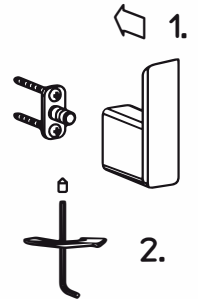

0505 001 01  
0505 001 02

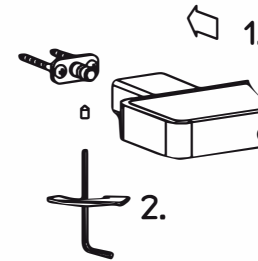

0566 001 40  
0566 001 60

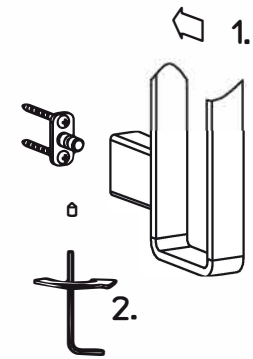

0550 001 40

5.



1.

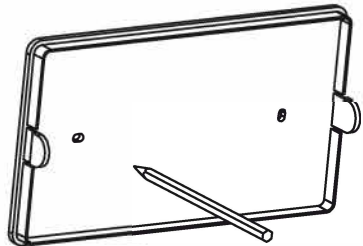

2.

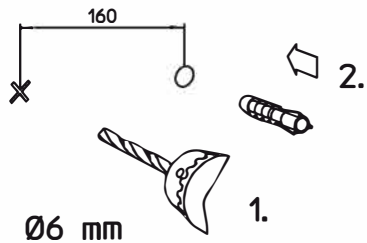

3.

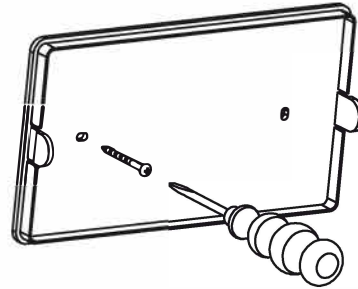

4.

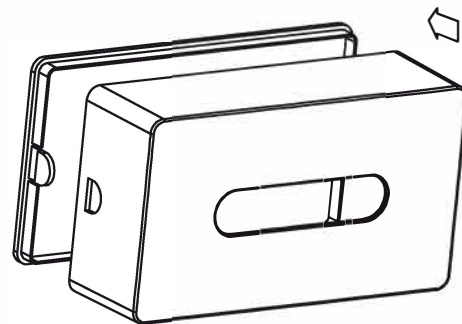

5.

0557 001 00

**ACHTUNG:**

Das beigefügte, universelle Befestigungsmaterial ist nicht für alle Untergründe geeignet. Bitte verwenden Sie nur - für den jeweiligen Untergrund - geeignete Schrauben und Dübel. Bitte prüfen Sie deshalb vor der Verwendung sorgfältig, ob das beigefügte Befestigungsmaterial für den vorgesehenen Untergrund tauglich ist.

**CAUTION:**

The universal fastening accessories supplied with the product are not suitable for all substrates. Please only use screws and plugs that are suitable for the substrate concerned. Therefore, before using the accessories, please carry out a thorough check to ensure that the fastening accessories supplied with the product are suitable for the intended substrate.

**ATTENTION :**

le matériel de fixation universel fourni ne convient pas atous les supports. Veuillez utiliser uniquement les vis et les chevilles appropriées au support respectif. C'est pourquoi, nous vous prions de vérifier s'ogneusement avant toute utilisation si le matériel de fixation fourni est compatible avec le support prévu.

**ATENCION:**

El material de fijación universal adjunto no es apto para todos los fondos. Le rogamos que utilice solo los tornillos y espigas apropiados para cada fondo. Por ello, compruebe con seguridad si el material de fijación adjunto es sumergible en el fondo en cuestión.

**OPGELET!**

Het bijgeleverde, universele bevestigingsmateriaal is niet geschikt voor alle ondergronden. G ebruik alleen schroeven en pluggen die geschikt zijn voor de betreffende ondergrond. Controleer daarom a.u.b. v66r gebruik zorgvuldig of het bijgeleverde bevestigingsmateriaal geschikt is voor de bestaande ondergrond.