

HELM

ZH5646.X

Termostatico incasso doccia con deviatore 2/3 vie. / Built-in thermostatic shower mixer and 2/3 way diverter.



Termostatico incasso doccia da 1/2", in acciaio inox AISI 316L, e deviatore a 2/3 vie con apertura/chiusura acqua.

1/2" built-in thermostatic shower mixer and 2/3 way diverter in AISI 316L stainless steel, with water on/off function.

R97810

Parte incasso termostatico 2 vie / Built-in part -
2 way thermostatic mixer







R97815

Parte incasso termostatico 3 vie / Built-in part -
3 way thermostatic mixer

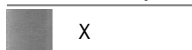
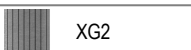
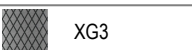
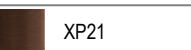
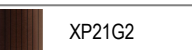
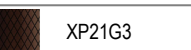
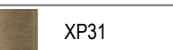
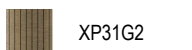
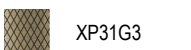

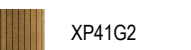
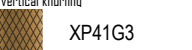
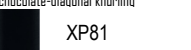
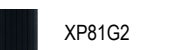
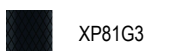
Finiture / Finishes

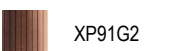
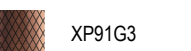
 X Acciaio inox spazzolato / Brushed stainless steel	 XG2 Acciaio inox spazz.-godr. verticale / Br. stainless steel-Vertical knurling	 XG3 Acciaio inox spazz.-godronatura diagonale / Br. stainless steel-diagonal knurling	 XP21 Brushed PVD chocolate / Brushed PVD chocolate	 XP21G2 Brushed PVD chocolate godronatura verticale / Brushed PVD chocolate vertical knurling	 XP21G3 Brushed PVD chocolate-godronatura diagonale / Brushed PVD chocolate-diagonal knurling	 XP31 Brushed PVD British gold / Brushed PVD British gold
 XP31G2 Br. PVD British gold-godr. verticale / Br. PVD British gold-vertical knurling	 XP31G3 Br. PVD British gold-godr. diagonale / Br. PVD British gold-diagonal knurling	 XP41 Brushed PVD gold / Brushed PVD gold	 XP41G2 Br. PVD gold-godronatura verticale / Brushed PVD gold-vertical knurling	 XP41G3 Br. PVD gold-godr. diagonale / Br. PVD gold-diagonal knurling	 XP81 PVD Brushed Total Black / PVD Brushed Total Black	 XP81G2 Br. PVD Total Black-godr. verticale / Br. PVD Total Black-vertical knurling
 XP81G3 Br. PVD Total Black-godr. diagonale / Br. PVD Total Black-diagonal knurling	 XP91 Brushed PVD copper / Brushed PVD copper	 XP91G2 Br. PVD copper-godr. verticale / Br. PVD copper-vertical knurling	 XP91G3 Br. PVD copper-godr. diagonale / Br. PVD copper-diagonal knurling			

HELM

ZH5646.X

Disegno Complessivo / Overall Drawing

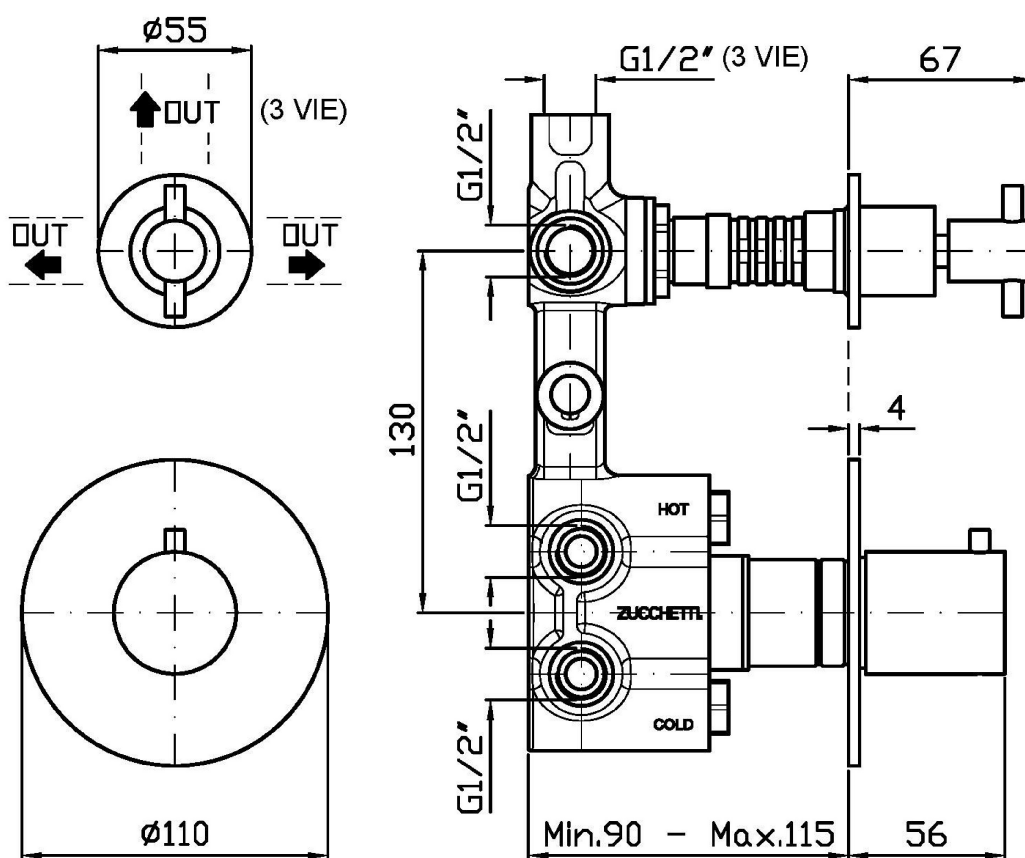

HELM

ZH5646.X

Esplosi / Exploded

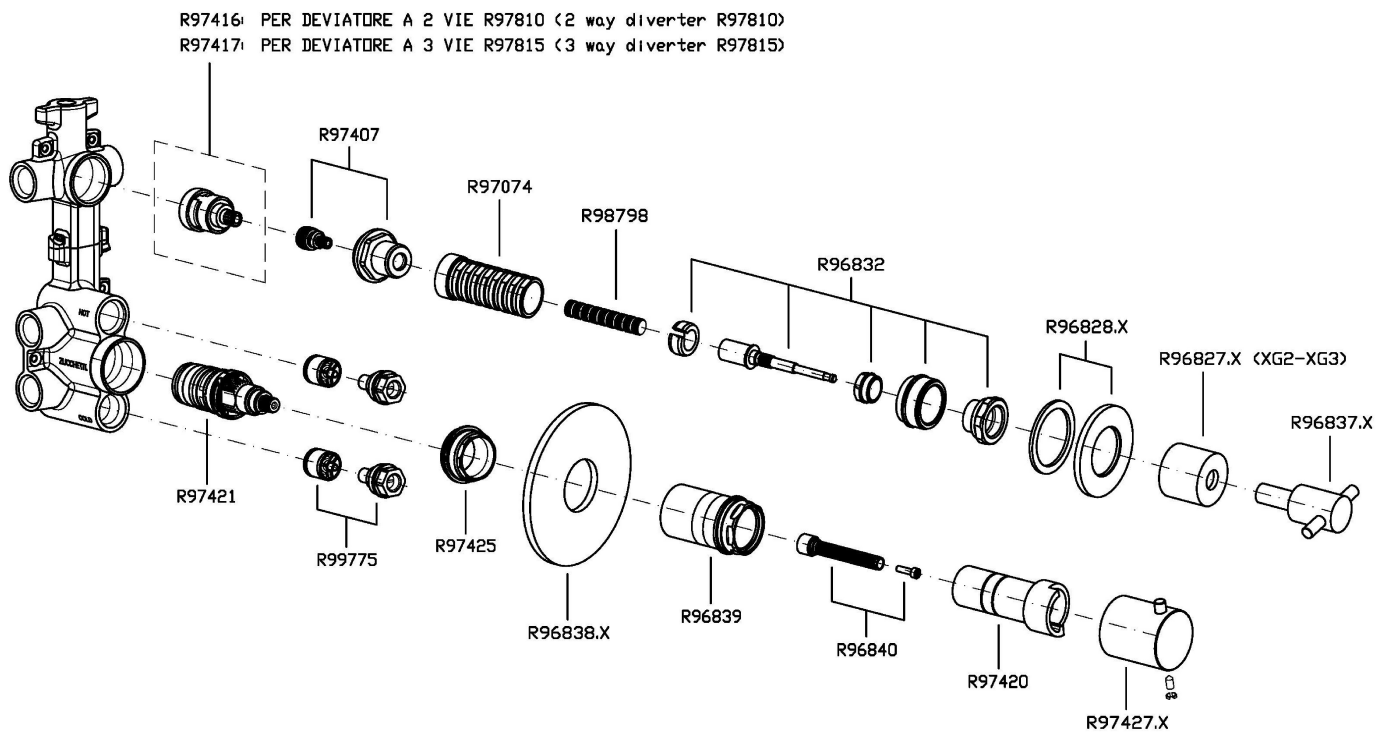

HELM

ZH5646.X Portate / Flowrates (lt/min)

PRESSIONE PRESSURE	1 BAR	2 BAR	3 BAR	4 BAR	5 BAR
DEVIATORE <i>P1</i>	11,5	16,2	19,5	23,2	26
<i>P2</i>					
<i>P3</i>					
<i>P4</i>					
<i>P5</i>					

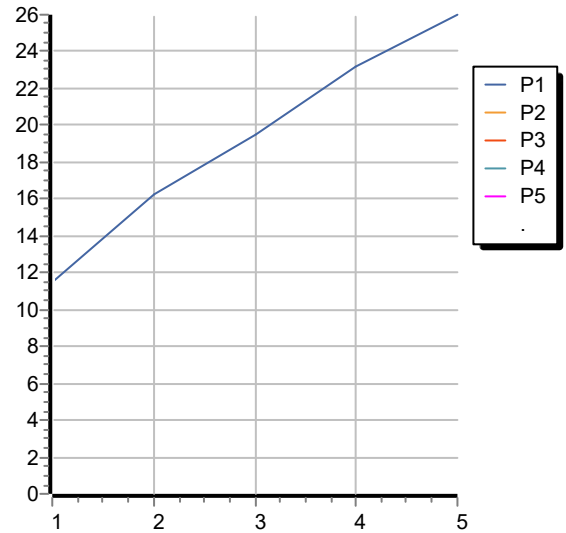

HELM

ZH5646.X Pesi e Misure / Weights and Sizes

Peso (Kg) Weight (lb)	1,60 (Kg)	3,53 (lb)
Volume test (dc3) - (in3)	11,01 (dc3)	671,87 (in3)
h (mm) - (in)	90,00 (mm)	3,54 (in)
L1 (mm) - (in)	335,00 (mm)	13,19 (in)
L2 (mm) - (in)	365,00 (mm)	14,37 (in)

