

## MISCELLANEOUS

R97755

















Scarico universale. / Pop-up waste.



Scarico universale. Chiusura a pressione.

Pop-up waste, with push system.

### Finiture / Finishes

 C3 Cromo / Chrome	 C8 Nickel Spazzolato / Brushed Nickel	 C40 Nickel Lucido / Polished Nickel	 C41 Oro / Gold	 C50 Oro spazzolato / Brushed Gold	 C51 Metal Black / Metal Black	 C51 Metal Black spazzolato / Brushed Metal Black
 P70 PVD Oro Rosa / PVD Rose Gold	 W1 Bianco Opaco Goffrato / Embossed Matt White	 N1 Nero Opaco Goffrato / Embossed Matt Black	 N6 Nero opaco / Matt black	 L5 Blu mediterraneo / Mediterranean blu	 P21 PVD brushed chocolate / PVD brushed chocolate	 P31 Brushed PVD British gold / Brushed PVD British gold
 P41 PVD Oro Spazzolato / PVD Brushed Gold	 P81 Brushed total black PVD / Brushed total black PVD	 P91 Brushed PVD Copper / Brushed PVD Copper				

## MISCELLANEOUS

R97755

Disegno Complessivo / Overall Drawing

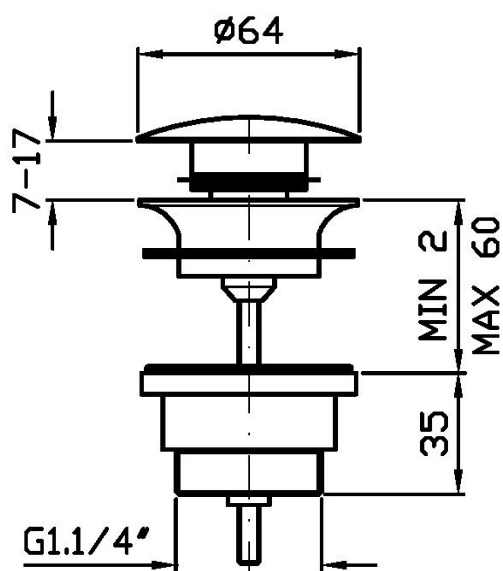

Note / Notes

## MISCELLANEOUS

R97755

Pesi e Misure / Weights and Sizes

Peso ( Kg ) Weight ( lb )	0,36 ( Kg )	0,79 ( lb )
Volume test ( dc3 ) - ( in3 )	0,47 ( dc3 )	28,68 ( in3 )
h ( mm ) - ( in )	94,00 ( mm )	3,70 ( in )
L1 ( mm ) - ( in )	71,00 ( mm )	2,80 ( in )
L2 ( mm ) - ( in )	71,00 ( mm )	2,80 ( in )

