

S

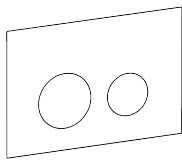

Loop

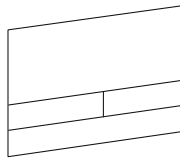

Square

9940301, S240501, S240503, S24061X, S24092X, S24085X

1

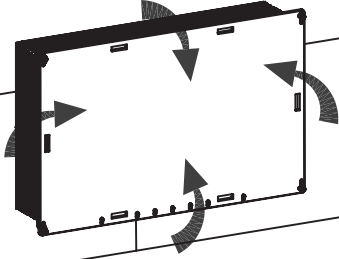

2

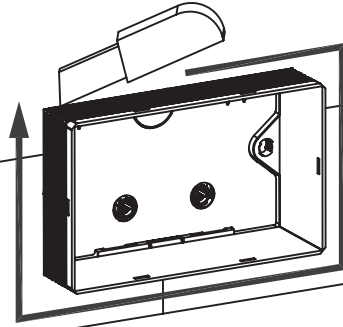

3

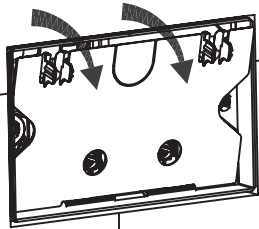

4

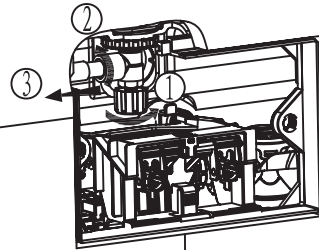

5

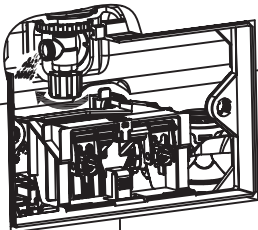

6

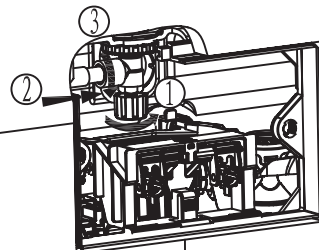

7

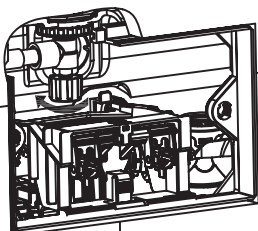

8

"Click"

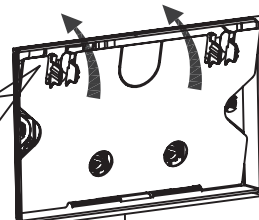
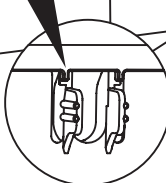

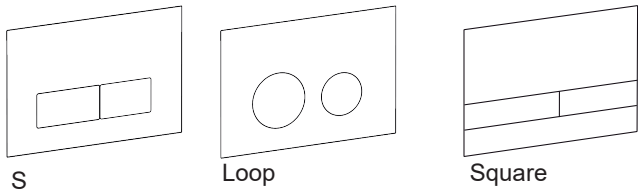

9940301, S240501, S240503, S24061X, S24092X, S24085X

