

Dati tecnici Technical features

Max contenuto d'acqua Max water capacity	310 l
Peso netto Net weight	60 Kg

Dati dimensionali Dimensional features

Volume d'imballo Packaging volume	1.3 m ³
--------------------------------------	--------------------

Installazioni disponibili Installations allowed

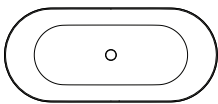

CENTRO STANZA

Disegno tecnico / Technical drawing

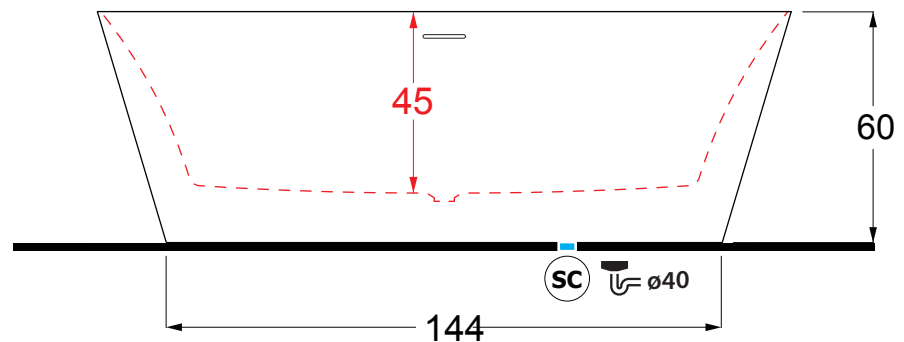
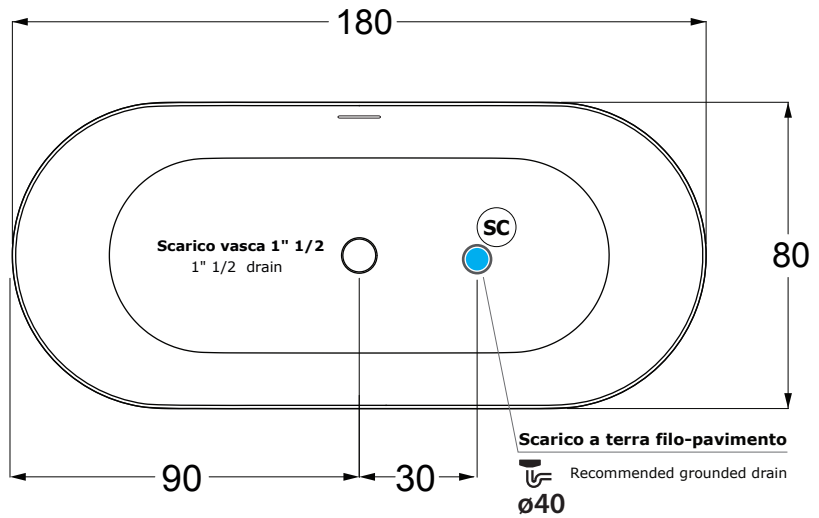

Scarico a terra consigliato filo-pavimento **SC** Recommended grounded drain ø40

Punti di appoggio a terra / Ground support points

VISTA DA SOTTO - posizione piedini

