

DE	Montageanleitung	2
FR	Instructions de montage	3
EN	Assembly instructions	4
IT	Istruzioni per Installazione	5
ES	Instrucciones de montaje	6
NL	Handleiding	7
DK	Monteringsvejledning	8
PT	Manual de Instalação	9
PL	Instrukcja montażu	10
CS	Montážní návod	11
SK	Montážny návod	12
ZH	组装说明	13
RU	Инструкция по монтажу	14
FI	Asennusohje	15
SV	Monteringsanvisning	16
LT	Montavimo instrukcijos	17
HR	Uputstva za instalaciju	18
RO	Instrucțiuni de montare	19
EL	Οδηγία συναρμολόγησης	20
SL	Navodila za montažo	21
ET	Raigaldusjuhend	22
LV	Montāžas instrukcija	23
SR	Uputstvo za montažu	24
NO	Montasjeveiledning	25
BG	Ръководство за монтаж	26
JP	施工説明書	27
UA	Інструкція по збірці	28
AR	تعليمات التجميع	29
TR	Montaj kılavuzu	30
HU	Szerelési útmutató	32
HE	הוראות הרכבה	33

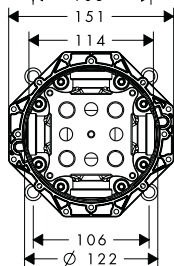

iBox universal

01800180

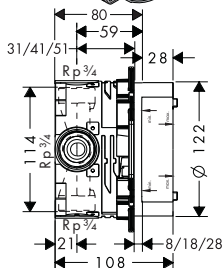
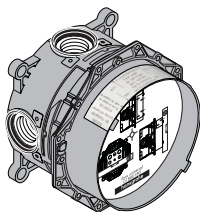



Rohmontage

- Der rotationsymmetrische Grundkörper der iBox ist universell einsetzbar, horizontal wie vertikal. Ausgenommen bei der Montage der Wannenarmatur mit Sicherungskombination, hier ist nur der vertikale Einbau möglich. Da bei einem Defekt der Funktionsteile Wasser an der iBox austreten kann, muss die iBox über der Wanne montiert werden, damit austretendes Wasser in die Wanne abfließen kann!
- Die iBox ist sowohl für Wannen- als auch für Brauseninstallation geeignet. Bei Einhand Wannenmischer / Thermostat mit Absperr- und Umstellventil ist der untere Abgang vorrangig. Wird nur ein Abgang benötigt, kann wahlweise der obere oder untere Abgang angeschlossen werden. Der nicht benötigte Abgang muss mit einem Stopfen abgedichtet werden.
- Große Druckunterschiede zwischen den Kalt- und Warmwasseranschlüssen müssen ausgeglichen werden.
- Grundkörper so einbauen, daß sich der Warmwasseranschluß links und der Kaltwasseranschluß rechts befindet.
- Einbautiefe 80 mm bis 108 mm.
- Verlängerung 25 mm
- Verlängerung 22 mm (bei geringer Einbautiefe) siehe Montageanleitung Fertigset

Der Grundkörper kann entsprechend den baulichen Gegebenheiten montiert werden (Montagebeispiele siehe Seite 41 - 42).

- A** Installation auf die Wand.
B Installation auf die Wand. Hier mit flexiblem Abstandshalter durch 10er Stockschrauben.
C Montage auf Trägersystem.
D Installation an Fertighaus-Montageplatten oder Fertigezellen.
E Installation direkt in die Wand.
F Installation mit Montageschienen

Installationsbeispiele mit Maßangaben und Leitungsdimensionierung sind ab Seite 34 zu finden. Die in der Montageanleitung angegebenen Montagemaße sind ideal für Personen von ca. 1800 mm Körpergröße und müssen gegebenenfalls angepasst werden. Hierbei ist darauf zu achten, dass sich bei geänderter Montagehöhe die Mindesthöhe ändert und die Änderung der Anschlussmaße berücksichtigt werden

müssen. Die Verbrauchswerte wurden praxisnah mit den dazugehörigen Armaturen (Thermostat/Mischer/ Unterputzventil) gemessen.

Montage-Tipp

Um Anschlussstücke einzudrehen, die iBox mittels eines Rohrstücks in den Schraubstock einspannen.

Spülen

Komplette Installation gemäß DIN 1988 / EN 1717 spülen. Die Pfeile auf dem Spülblock zeigen, welcher Zulauf mit welcher Abgangsleitung verbunden ist, z. B. Kaltwasser mit dem oberen Abgang und Warmwasser mit dem unteren Abgang. Falls nur ein Abgang benötigt wird, muß nach dem ersten Spülvorgang der Spülblock um 90° gedreht werden.

iBox in Kombination mit einer Exafill Wanneneinlauf mit Ab- und Überlaufgarnitur (siehe Seite 44)

Technische Daten

Betriebsdruck:	max. 1 MPa
Empfohlener Betriebsdruck:	0,1 - 0,5 MPa
Prüfdruck:	1,6 MPa (1 MPa = 10 bar = 147 PSI)
Heißwassertemperatur:	max. 60°C
Anschlussmaße:	R $\frac{3}{4}$
Anschlüsse:	kalt rechts - warm links
Freier Durchfluss bei 0,3 MPa:	
Brausemischer:	32 l/min
Thermostat:	36 l/min
Thermostat mit Absperrventil:	26 l/min
Thermostat mit Absperr- und Umstellventil:	26 l/min
Thermostat HighFlow (Abgang 1 + 2):	58 l/min
iControl:	30 l/min
Wannenmischer:	31 l/min // 24 l/min
Wannenmischer mit integrierter	
Sicherungskombination:	25 l/min // 24 l/min



Montage de base

- La pièce de base rotative symétrique de l'iBox a une possibilité de montage universel, horizontal comme vertical. Sauf pour le montage de u mitigeur bain-douche avec disconnecteur ou là le montage vertical seulement est possible. Parceque l'eau pourrait fuir de l'iBox en cas de défaillance des pièces de fonctionnement, l'iBox doit être monté au dessus de la baignoire pour que la fuite puisse s'écouler dans la baignoire.
- L'iBox est appropriée aussi bien pour les baignoires que pour les douches. Pour un mitigeur bain/douche / mitigeur thermostatique avec robinet d'arrêt et inverseur, la sortie inférieure est prioritaire. Si une seule sortie est nécessaire, il est possible de raccorder au choix soit la sortie supérieure, soit la sortie inférieure. La sortie non utilisée doit être condamnée avec un bouchon.
- Il est conseillé d'équilibrer les pressions de l'eau chaude et froide.
- Monter la pièce de base pour que l'eau chaude arrive sur le côté gauche et l'eau froide sur le côté droit.
- Profondeur d'encastrement: 80 mm à 108 mm.
- jeu de rallonge 25 mm
- Rallonge de 22 mm (pour profondeur de montage trop faible) voir les instructions de montage Set de finition

La pièce de base peut être installée selon les différentes (possibilités voir pages 41 - 42).

- A** Installation au mur.
- B** Installation au mur avec une vis de distance.
- C** Montage sur système support.
- D** Installation encastrée sur plaques de montage d'un préfabriqué ou sur cellules préparées.
- E** Installation directement dans le mur.
- F** Installation avec rail de fixation

Des exemples d'installation avec indication de cotes et dimensions des conduites sont fournis à partir de la page 34.

Les dimensions d'installation indiquées dans la notice de montage sont idéales pour des personnes d'une taille de 1800 mm environ et doivent être ajustées selon le cas. Tenir compte pour cela du fait qu'un changement de hauteur modifie la hauteur minimum et que la modification des cotes de raccord doit entrer en ligne de compte. Les valeurs de consommation ont été mesurées

dans la pratique, avec les robinetteries correspondantes (thermostat/mélangeur/vanne sous crépi)

Exemple de montage

Pour monter les différents raccords, on peut fixer l'iBox grâce à un tuyau et un étai.

Rinçage

Rincer l'installation complète conformément à la réglementation et aux normes. Les flèches sur le bloc de rinçage indiquent quelle arrivée est reliée à quelle conduite de sortie, par ex. eau froide à la sortie supérieure et eau chaude à la sortie inférieure. Si une seule sortie est nécessaire, le bloc de rinçage doit être tourné de 90° après le premier rinçage.

iBox en combinaison avec un remplissage exafill avec mécanisme de vidage et de trop plein (voir pages 44)

Informations techniques

Pression de service autorisée:	max. 1 MPa
Pression de service conseillée:	0,1 - 0,5 MPa
Pression maximum de contrôle:	1,6 MPa (1 MPa = 10 bar = 147 PSI)
Température d'eau chaude:	max. 60°C
Dimension d'arrivée:	R _{3/4}
Raccordement:	froide à droite - chaude à gauche
Débit libre à 0,3 MPa:	
Mitigeur douche:	32 l/min
Mitigeur thermostatique:	36 l/min
Mitigeur thermostatique avec robinet d'arrêt:	26 l/min
Mitigeur thermostatique avec robinet d'arrêt et inverseur:	26 l/min
Mitigeur thermostatique HighFlow (Sortie 1 + 2):	58 l/min
iControl:	30 l/min
Mitigeur bains-douches:	31 l/min // 24 l/min
Mitigeur bains-douches avec disconnecteur:	25 l/min // 24 l/min



Concealed installation

- The rotation symmetrical body is horizontal and vertical usable. Only exception installing the bath-shower mixer with integrated safety combination. In this case only a vertically installation is possible. Install the iBox always above the bath-tup. If parts of the iBox will broken, the water can flow in there!
- The iBox is suitable for both bath and shower applications. When using the bath-shower mixer / thermostatic mixer with shut-off and diverter unit outlet, the lower outlet must have priority. If you need only one outlet, choose either the top or the bottom outlet and connect it. Close the unused outlet with a plug.
- The hot and cold supplies must be of equal pressures.
- Install body with the hot water supply left and cold water supply right.
- Depth of fitting: 80 mm to 108 mm.
- extension 25 mm
- Extension Set 22 mm (when wall is not deep enough) see installation instructions Finish set

The basic set can depending on the building application be mounted in different ways, Installation examples please see page 41 - 42.

- A** Direct wall installation.
- B** Direct wall installation with 10 mm adjustable mounting studs.
- C** Installation on carrier system.
- D** Installation on prefabricated house installation panels or finished cells.
- E** Brick wall installation.
- F** Installation with fixation set

Installation examples with measurements and pipe dimensions can be found starting on page 34.

The installation dimensions stated in these installation instructions are ideal for people of approximately 1800 mm in body height. The dimensions can be altered if required. In this case, pay attention to the fact that a change of installation height will also change the minimum height, and that the altered mounting dimensions must be taken into consideration. The consumption was measured in combination with the appropriate fittings (thermostat/mixer/in-wall valve) to reflect actual application in practice.

Installation tip

To install the supply pipes, fix the iBox with a pipe in a vice.

Flush piping system

To complete the installation flush out both hot and cold water supply. The arrows on the flush body show which inlet is connected to which outlet pipe, e.g. cold water to the upper outlet and hot water to the lower outlet. If only one outlet is required, the flush body must be turned 90° after the first flush.

iBox in combinaton with an Exafill bath filler with overflow and waste (see page 44)

Technical Data

Operating pressure:	max. 1 MPa
Recommended operating pressure:	0,1 - 0,5 MPa
Test pressure:	1,6 MPa
	(1 MPa = 10 bar = 147 PSI)
Hot water temperature:	max. 60°C
Centre distance:	R ³ / ₄
Connections:	cold right - hot left
Rate of flow by 0,3 MPa:	
Shower mixer:	32 l/min
Thermostatic mixer:	36 l/min
Thermostatic mixer with shut off unit:	26 l/min
Thermostatic mixer with shut off and diverter unit:	26 l/min
Thermostatic mixer HighFlow (Outlet 1 + 2):	58 l/min
iControl:	30 l/min
Bath-shower mixer:	31 l/min // 24 l/min
Bath-shower mixer with integrated safety combination:	25 l/min // 24 l/min



Installazione della tubazione

- La rotazione simmetrica del corpo permette di raccordarsi agli attacchi sia verticalmente che orizzontalmente. Set vasca/doccia con valvola antiriflusso, è obbligatorio. Solo in caso di installazione del raccordarsi agli attacchi verticalmente. Installare sempre l'iBox sopra alla vasca o al piatto doccia, poiché in caso di fuoriuscita d'acqua questa verrà convogliata allo scarico.
- L'iBox è adatto tanto ad installazioni per vasca quanto per doccia. Per i miscelatori monocomando per vasca / termostatico con rubinetto di arresto e deviatore l'uscita inferiore ha la prevalenza. Se si utilizza solo un'uscita, a scelta può essere collegata l'uscita superiore o quella inferiore. L'uscita non utilizzata deve essere chiusa con un tappo.
- Attenzione! Compensare le differenze di pressione tra i collegamenti dell'acqua fredda e dell'acqua calda.
- Installare il corpo incasso in modo tale che il raccordo dell' acqua calda si trovi a sinistra e il raccordo dell' acqua fredda a destra.
- Profondità d'installazione: da 80 mm a 108 mm.
- Prolunga 25 mm
- Prolunga 22 mm x set esterno (in caso di incasso troppo esterno al muro) vedi le istruzioni di montaggio Set esterno

Il corpo incasso può essere installato conformemente alle condizioni edilizie, vedi esempi di installazione alle pagg. 41 - 42.

- A** Installazione a muro.
- B** Installazione a muro. Qui con la regolazione della distanza (vite nr 10).
- C** Montaggio su struttura portante.
- D** Installazione su pannelli di montaggio o celle prefabbricate.
- E** Installazione diretta a muro.
- F** Installazione con pareti in cartongesso

Esempi per l'installazione con indicazioni delle misure e per le dimensioni delle tubature sono riportati a partire dalla pagina 34.

Le quote di montaggio indicate nelle istruzioni di montaggio sono ideali per persone grandi circa 1800 mm e eventualmente vanno adattate. A ciò bisogna fare attenzione, che ad altezza di montaggio

cambiata l'altezza minima necessaria indicata cambia e che bisogna considerare la modifica delle quote di collegamento. I valori di consumo sono stati misurati nella pratica con le armature appartenenti (Termostato/Miscelatore/Valvola sotto-intonaco).

Suggerimento per l'installazione

Per avvitare i raccordi bloccare l' iBox nella morsa come illustrato.

Lavaggio della tubazione

Eseguire il lavaggio della tubazione come suggerisce la normativa DIN 1988 / EN 1717. Le frecce sulla copertura del corpo indicano quale alimentazione è collegata a quale tubo di uscita (p.e. acqua fredda all'uscita superiore e acqua calda all'uscita inferiore). Nel caso è richiesta una sola uscita, dopo il primo lavaggio la copertura del corpo deve essere girata di 90°.

iBox in combinazione con Exafill scarico con erogazione al troppo pieno (vedi pagg. 44)

Dati tecnici

Pressione d'uso:	max. 1 MPa
Pressione d'uso consigliata:	0,1 - 0,5 MPa
Pressione di prova:	1,6 MPa
	(1 MPa = 10 bar = 147 PSI)
Temperatura dell'acqua calda:	max. 60°C
Distanza di raccordo:	R ^{3/4}
Raccordi:	fredda a destra - calda a sinistra
Portata a 0,3 MPa:	
Miscelatore doccia:	32 l/min
Termostatico:	36 l/min
Termostatico con rubinetto di arresto:	26 l/min
Termostatico con rubinetto di arresto e deviatore:	26 l/min
Termostatico HighFlow (Uscita 1 + 2):	58 l/min
iControl:	30 l/min
Miscelatore vasca/doccia:	31 l/min // 24 l/min
Miscelatore vasca incasso con sicurezza (valv. antiriflusso):	25 l/min // 24 l/min





Montaje del cuerpo empotrado

- El cuerpo base del iBox universal se puede montar en plano horizontal y vertical. La única excepción se da al instalar el mezclador de baño/ducha con combinación de seguridad integrada. En tal caso, solo la instalación vertical es posible. Instalar el iBox siempre por encima de la bañera ya que, si se rompiera alguna pieza del iBox, el agua estaría contenida.
- El iBox puede ser utilizado tanto en una instalación de bañera como de ducha. En mezcladores de bañera monomando, con termostato con válvula de cierre e inversión, tiene prioridad la salida inferior. Si solo se necesita una salida se puede conectar tanto en la salida superior como en la inferior. La salida que no se utilice deberá estar cerrada con un tapón.
- Grandes diferencias de presión en servicio entre agua fría y agua caliente deben equilibrarse.
- Montar el cuerpo de tal manera que el agua caliente esté a la izquierda y el agua fría está en la derecha.
- Profundidad de montaje 80 mm a 108 mm.
- Prolongación 25 mm
- Alargo 22 mm (en caso de pared delgada) ver instrucciones de montaje Embellecedor exterior

El cuerpo empotrado puede ser colocado según los ejemplos expuestos en las páginas 41 - 42.

- A** Instalación directamente sobre la pared.
- B** Instalación sobre la pared. Aquí con soportes de distanciamiento y tornillos de acero de 10.
- C** Montaje en el sistema portante.
- D** Instalación en placas murales prefabricadas o en celdas prefabricadas.
- E** Instalación directa en la pared.
- F** Instalación con set de guías de fijación

A partir de la página 34 puede consultar ejemplos de instalación y dimensionamiento de la conducción.

Las medidas indicadas en las instrucciones de montaje resultan ideales para personas de 1800 mm de altura, por lo que deberán ajustarse siempre que sea necesario. En este sentido, es importante tener en cuenta que, en caso de modificación de la altura de montaje, cambia la altura mínima y habrá que adaptar las medidas de conexión. Los valores de consumo han sido medidos en la práctica con los grifos correspondientes (termostato/mezclador/válvula empotrada).

Recomendación

Para enroscar los codos de conexión, fijar el iBox universal mediante un trozo de tubería en un tornillo de banco.

Purga de la tubería

Purgar la instalación según la normativa DIN 1988/ EN 1717. Las flechas del lavabo indican qué tubería de entrada está conectada a qué tubería de salida, por ejemplo, agua fría a la salida superior y agua caliente a la salida inferior. Si solamente se requiere una salida, se debe girar el bloque de descarga 90° después de la primera descarga.

iBox universal en combinación con Exafill, vaciador automático con chorro incorporado y rebosadero (ver página 44)

Datos técnicos

Presión en servicio:	max. 1 MPa
Presión recomendada en servicio:	0,1 - 0,5 MPa
Presión de prueba:	1,6 MPa (1 MPa = 10 bar = 147 PSI)
Temperatura del agua caliente:	max. 60°C
Racores excéntricos:	R ³ / ₄
Racores excéntricos:	a la derecha frío - a la izquierda caliente
Caudal con 0,3 MPa	
Monomando ducha:	32 l/min
Termostato:	36 l/min
Termostato con llave de paso:	26 l/min
Termostato con llave de paso y distribuidor:	26 l/min
Termostato HighFlow (Salida 1 + 2):	58 l/min
iControl:	30 l/min
Monomando baño/ducha:	31 l/min // 24 l/min
Monomando baño ducha con válvula anti-retorno:	25 l/min // 24 l/min





Ruwbouw

- Het symmetrische basisgarnituur iBox universeel is zowel horizontaal als verticaal toe te passen. Uitgezonderd bij montage van een badmengkraan met zekerheidscombinatie, deze kan alleen verticaal worden ingebouwd. Bij een defect functiedeel kan mogelijk water uit de iBox weglopen. Daarom moet de iBox boven het bad gemonteerd worden. Het lekwater wordt dan in het bad afgevoerd!
- De iBox is zowel geschikt voor installatie bij het bad als bij de douche. Bij de ééngreeps badmengkraan / thermostaat met stop- en omstelkraan heeft de onderste uitgang voorrang. Indien slechts één uitgang vereist is, kan naar keuze de bovenste of de onderste uitgang aangesloten worden. De niet-vereiste uitgang moet met een stop worden afgesloten.
- Grote drukverschillen tussen de koud- en warmwatertoevoer dienen vermeden te worden.
- Basisgarnituur zo inbouwen, dat de aansluiting voor warm water links en voor koud water rechts zit.
- Inbouwdiepte 80 mm tot 108 mm.
- Verlengstuk 25 mm
- verlengset 22 mm (bij geringe inbouwdiepte) zie montagehandleiding Kleurset

Het basisgarnituur kan overeenkomstig de situatie ter plaatse worden ingebouwd. Montagevoorbeelden zie pag. 41 - 42.

- A** Installatie voor de wand.
- B** Installatie voor de wand.
- C** Montage op houdersysteem.
- D** Installatie op montageplaten voor prefab-huizen of kant-en-klare cellen.
- E** Installatie in de wand.
- F** Installatie met montageset

Installatievoorbeelden met massagegegevens en capaciteitsdimensionering staan op pagina 34.

De in de handleiding aangegeven montagegematen richten zich op personen van ca. 1800 mm groot en moeten indien nodig aangepast worden. Daarbij moet in acht genomen worden dat bij een gewijzigde montagehoogte ook de minimumhoogte verandert en dat de aansluitmaten overeenkomstig moeten worden aangepast. De verbruikswaarden werden in overeenstemming met de praktijk met de bijbehorende armaturen (thermostaat/mengkraan/inbouwventiel) gemeten.

Montagetip

Om aansluitingen in te draaien de iBox door middel van een koppeling in de bankschroef vastzetten.

Spoelen

De complete installatie overeenkomstig DIN 1988/ EN 1717 spoelen. De pijlen op het spoelblok geven aan welke toevoer met welke afvoerleiding is verbonden, bijv. koud water met de bovenste afvoer en warm water met de onderste. Als er maar één afvoer noodzakelijk is moet het spoelblok na het eerste spoelen 90° worden gedraaid.

iBox in combinatie met Exafill bad- vul-, afvoer- en overloopgarnituur (zie blz. 44)

Technische gegevens

Werkdruk: max.	max. 1 MPa
Aanbevolen werkdruk:	0,1 - 0,5 MPa
Getest bij:	1,6 MPa
	(1 MPa = 10 bar = 147 PSI)
Temperatuur warm water:	max. 60°C
Aansluitmaten:	R ^{3/4}
Aansluitingen:	koud rechts - warm links
Vrije doorstroom bij 0,3 MPa:	
Douchemengkraan:	32 l/min
Thermostaat:	36 l/min
Thermostaat met stopkraan:	26 l/min
Thermostaat met stop- en omstelkraan:	26 l/min
Thermostaat HighFlow (Uitgang 1 + 2):	58 l/min
iControl:	30 l/min
Badmengkraan:	31 l/min // 24 l/min
Badmengkraan met geïntegreerde zekerheidscombinatie:	25 l/min // 24 l/min





Råmontage

- iBoxens grundkrop er universel - den kan monteres horisontalt og vertikalt. Der er dog en undtagelse ved montering af kar-/brusearmaturer med integreret sikkerhedskombination. Her er kun vertikal montering mulig. Da der ved evt. defekt vil komme vand i i-boxen, skal denne monteres over karet, således at vandet ledes ned i karet!
- iBoxen er egnet til såvel kar- som bruseinstallation. Ved 1-grebs kararmatur / termostat med afspæringsventil og omskifter er den nederste afgang den primære afgang. Kræves der kun én afgang, kan den øverste eller den nederste afgang anvendes. Den afgang, der ikke er brug for, skal lukkes med en prop.
- Større trykforskelle mellem koldt og varmt vand bør udjævnes.
- Grundkroppen indbygges således, at varmtvandstilslutningen er til venstre og koldt vandstilslutningen er til højre.
- Monteringsdybde 80 mm til 108 mm.
- Forlængersæt 25 mm
- Forlænger 22 mm (ved for stor indbygningsdybde) se monteringsvejledning Kappesæt

For monteringsseksempler se s. 41 - 42.

- A** Installation på væggen.
- B** Installation på væggen. Her med fleksibel afstandsholder med 10 mm justerbar monteringskrue.
- C** Montering på skinnesystemet.
- D** Installering på monteringsplader til præfabrikerede huse.
- E** Installation direkte i væggen.
- F** Installation med monterings-skinnesæt

Installationseksempler med mål og ledningsdimensioner kan findes fra side 34.

Målene i monteringsanvisningen er ideal til personer med en størrelse på 1800 mm og skal i givet fald tilpasses. Herved skal der tages hensyn til, at den mindste højde i tilfælde af en ændret monteringshøjde ændres og at der skal tages hensyn til de ændrede tilslutningsmål. Værdierne for forbruget blev målt praksisorienteret og med de tilsvarende armaturer (termostat/blander/indbygget ventil).

Monterings-tips

For montering af tilslutningsvinkler, kan iBoxen fastspændes i en skruevinge ved hjælp af et rørstyrkke.

Gennemskylning

Den komplette installation skal gennemskyldes efter DIN 1988 / EN 1717. Pilene på skylleblokken viser, hvilken tilløb der er forbundet med hvilken udgangsledning, f.eks. er koldt vand forbundet med den øverste udgang, og varmt vand med den nederste udgang. Såfremt der kun kræves en udgang, skal skylleblokken drejes 90° efter første skylning.

iBox i kombination med Exafill påfyldnings- og overløbsgarniture (se s. 44)

Tekniske data

Driftstryk:	max. 1 MPa
Anbefalet driftstryk:	0,1 - 0,5 MPa
Prøvetryk:	1,6 MPa (1 MPa = 10 bar = 147 PSI)
Varmtvandstemperatur:	max. 60°C
Tilslutningsmål:	R $\frac{3}{4}$
Tilslutninger:	Koldt højre - varmt venstre
Fri gennemstrømning ved 0,3 MPa:	
Brusearmaturer:	32 l/min
Termostat:	36 l/min
Termostat med afspæringsventil:	26 l/min
Termostat med afspæringsventil og omskifter:	26 l/min
Termostat HighFlow (Afgang 1 + 2):	58 l/min
iControl:	30 l/min
Kararmaturer:	31 l/min // 24 l/min
Kararmatur med integreret sikkerhedskombination.:	25 l/min // 24 l/min





Instalação embutida na parede

- O corpo de rotação simétrica pode ser instalado quer na horizontal quer na vertical. A única exceção é ao instalar uma misturadora de banheira/chuveiro com combinação de segurança. Neste caso, apenas é possível uma instalação vertical. Instalar a iBox sempre sobre a banheira. No caso de haver algum defeito nas peças da iBox a água pode fluir para lá.
- A iBox é aplicável numa instalação de banheira e de chuveiro. Na misturadora de monobloco para banheira / misturadora termostática com inversor/válvula de corte, a saída inferior é prioritária. Se for apenas necessária uma saída, é possível conectar a saída superior ou inferior. A saída que não é necessária deve ser vedada com um tampão.
- Grandes diferenças entre as pressões das águas quente e fria devem ser compensadas.
- Instalar o corpo com a ligação para água quente à esquerda e a ligação para a água fria à direita.
- Profundidade de montagem 80 mm até 108 mm.
- Crescente 25 mm
- Crescente 22 mm (quando instalado demasiado longe da parede) ver instruções de montagem Conjunto completo

O corpo pode, dependendo da construção, ser instalado de diferentes maneiras, ver nas páginas 41 - 42 exemplos de instalação

- A** Instalação sobre a parede.
- B** Instalação sobre a parede com calçoa ajustáveis de 10 mm.
- C** Montagem no sistema de suporte.
- D** Instalação nas placas de montagem de pré-fabricado ou células pré-fabricadas.
- E** Instalação em paredes de tijolo.
- F** Instalação com set de fixação

Exemplos de instalação com indicações dimensionais e dimensionamento das tubagens, podem ser encontrados a partir da página 34.

As dimensões de montagem indicadas nas instruções de montagem são ideais para pessoas com uma altura aprox. 1800 mm e têm que ser eventualmente adaptadas. Neste contexto deve ter-se em atenção que alterações na altura de montagem obrigam a alterações

na altura mínima, bem como alterações nas dimensões de ligação. Os valores de consumo foram medidos em condições reais com o respetivo equipamento (termostato/misturadora/válvula embutida).

Conselho para montagem

Para instalar as curvas de ligação na iBox coloque um tubo na iBox e prenda-o num torno.

Purgar as tubagens

Para completar a instalação purgar as tubagens da água quente e da água fria. As setas no bloco de lavagem mostram as admissões e as respetivas tubagens de saída, p. ex., água fria com a saída superior e água quente com a saída inferior. Se apenas for necessária uma saída, o bloco de lavagem tem de ser girado em 90° após a primeira lavagem.

iBox em combinação com Exafill com bica e avisador (ver página (ver página 44))

Dados Técnicos

Pressão de funcionamento:	max. 1 MPa
Pressão de func. recomendada:	0,1 - 0,5 MPa
Pressão testada:	1,6 MPa (1 MPa = 10 bar = 147 PSI)
Temperatura da água quente:	max. 60°C
Distância entre eixos:	R ^{3/4}
Ligações:	fria à direita - quente à esquerda
Caudal a 0,3 MPa:	
Misturadora de chuveiro:	32 l/min
Misturadora termostática:	36 l/min
Misturadora termostática com válvula de corte:	26 l/min
Misturadora termostática com inversor/válvula de corte:	26 l/min
Misturadora termostática	
HighFlow (Saída 1 + 2):	58 l/min
iControl:	30 l/min
Misturadora de banheira/chuveiro:	31 l/min // 24 l/min
Misturadora de banheira/duche com combinação de segurança integrada:	25 l/min // 24 l/min





Montaż przyłączy

- Uniwersalny okrągły kształt korpusu iBox pozwala na dowolny sposób montażu i zabudowy, zarówno pionowy jak i poziomy. Z wyjątkiem montażu armatury wannowej ze zintegrowanym systemem zabezpieczającym do wylewki, możliwy jest tylko montaż pionowy. W przypadku uszkodzenia jakichkolwiek elementów przepływająca woda może kapać z iBoxa, dlatego też należy zamontować go nad wanną, dzięki czemu woda będzie mogła spływać do wanny.
- iBox można wykorzystać zarówno jako baterię wannową jak i jako baterię natryskową. Przy jednouchwytywym mieszaczu wannowym / termostat z zaworem odcinająco-przełączającym dolne wyjście ma pierwszeństwo. Jeżeli konieczne jest tylko jedno wyjście, to można podłączyć do wyboru górne lub dolne wyjście. Niewykorzystane wyjście należy zamknąć korkiem uszczelniającym.
- Znaczne różnice ciśnień na dopływach ciepłej i zimnej wody muszą zostać wyrównane.
- Korpus zabudować w taki sposób, aby przyłącza zimnej wody znajdowały się po prawej stronie, a ciepłej po lewej.
- Głębokość montażu 80 - 108 mm
- Przedłużka 25 mm
- Rozeta maskująca 22 mm (przy małej głębokości zabudowy) patrz Instrukcja montażu Elementy zewnętrzne

Korpus może zostać zabudowany w różnych stadiach budowlanych, przykłady montażowe patrz str.41 - 42.

- A** Instalacja na ścianie.
- B** Instalacja przed ścianą. Na śrubach gwintowanych M10 jako elementy dystansowe.
- C** Montaż na systemie stelaży.
- D** Instalacja w ścianach prefabrykowanych domów gotowych.
- E** Instalacja w ścianie.
- F** Instalacja z szynami mocującymi

Przykłady instalacji z podaniem ciężarów i rozmiarów przewodów, patrz od strony 34.

Wymiary montażowe podane w instrukcji montażowej są idealne dla osób o wzroście sięgającym ok.

1800 mm i w razie konieczności należy je dostosować. Należy przy tym zwrócić uwagę na fakt, iż przy

zmienionej wysokości montażu zmienia się minimalna wysokość, a także ulegają zmianie wymiary przyłączy. Wartości zużycia zostały zmierzone w praktyczny sposób za pomocą przynależnej armatury (termostat/mieszalnik/zawór podtynkowy).

Wskazówki montażowe

Aby dokręcić przyłącza, zamocować iBox w imadle.

Płukanie

Przepłukać całą instalację zgodnie z normą DIN 1988 / EN 1717. Strzałki na bloku płuczącym pokazują, który wlot jest podłączony do którego przewodu wylotowego, np. zimna woda z górnym wylotem i ciepła woda z dolnym wylotem. Jeśli wymagany jest tylko jeden wylot, blok płuczący należy obrócić o 90° po pierwszym procesie płukania.

iBox w kombinacji z odpływem wannowym Exafill posiadającym możliwość napełniania i opróżniania wanny (patrz strona 44)

Dane techniczne

Ciśnienie robocze:	maks. 1 MPa
Zalecane ciśnienie robocze:	0,1 - 0,5 MPa
Ciśnienie próbne:	1,6 MPa (1 MPa = 10 bary = 147 PSI)
Temperatura wody gorącej:	maks. 60°C
Wymiary przyłączy:	R ^{3/4}
Przyłącza:	Zimna z prawej - Ciepła z lewej
Swobodny przepływ przy 0,3 MPa:	
Mieszacz prysznicowy:	32 l/min
Termostat:	36 l/min
Termostat z zaworem odcinającym:	26 l/min
Termostat z zaworem odcinająco-przełączającym:	26 l/min
Termostat HighFlow (Wylot 1 + 2):	58 l/min
iControl:	30 l/min
Mieszacz wannowy:	31 l/min // 24 l/min
Mieszacz wannowy ze zintegrowanym systemem zabezpieczającym do wylewki:	25 l/min // 24 l/min





Hrubá montáž

- Rotačně symetrické základní těleso iBoxu je univerzálně použitelné, horizontálně jakož i vertikálně. Neplatí pro montáž vanové armatury s bezpečnostní kombinací, zde je možná pouze vertikální montáž. Protože v případě závady funkčních dílů může začít z jednotky iBox vytékat voda, musí být iBox instalován nad vanou, která vytékající vodu odvede.
- iBox je vhodný jak pro vanovou, tak i pro sprchovou instalaci. U vanové / termostat s uzavíracím a přepínacím ventilem jednoruční pákové baterie je prioritní spodní vývod. Pokud je potřeba pouze jeden vývod, je možné si zvolit horní nebo dolní vývod. Nepoužitý vývod musí být utěsněn zaslepovací zátkou.
- Je nutné vyrovnat velké rozdíly tlaku mezi připoji studené a teplé vody.
- Základní těleso zabudovat tak, aby se připojí teplé vody nacházel vlevo a připojí studené vody vpravo.
- Hloubka zabudování 80 mm až 108 mm.
- prodloužení 25 mm
- prodloužení 22 mm (při malé hloubce zabudování) viz montážní návod Vrchní sada

Základní těleso může být namontováno v souladu s podmínkami na stavbě, příklady montáže viz strana 41 - 42.

A Instalace na stěnu.

B Instalace před stěnu. Zde s variabilními rozpěrkami pomocí šroubů M 10.

C Montáž na nosný systém.

D Instalace na montážní desky nebo prefabrikované díly typizovaného domu.

E Instalace přímo do stěny.

F Instalace se sadou montážních lišt

Příklady instalace s údaji o rozměrech a dimenzování potrubí jsou uvedeny od strany 34.

Montážní rozměry uvedené v návodu pro montáž jsou ideální pro osoby s výškou postavy přibližně 1800 mm a v případě potřeby je nutné je přizpůsobit. Při tom je zapotřebí dbát nato, že se při změně výšce montáže změní požadovaná minimální výška a že je třeba brát ohled na připojovací rozměry. Spotřební hodnoty byly v praxi měřeny na příslušných armaturách (termostat/ baterie/podomítkový ventil).

Montážní tip

Aby bylo možno zatočit připojovací tvarovky do iBoxu, upněte iBox pomocí částí trubky do svěráku.

Propláchnutí

Propláchnout kompletní instalaci podle DIN 1988 / EN 1717. Šipky na splachovacím bloku ukazují, který přívod je spojen se kterým výstupním vedením, např. studená voda s horním výstupem a teplá voda se spodním výstupem. Pokud potřebujete pouze jeden výstup, je nutné po prvním splachování otočit splachovací blok o 90°.

iBox v kombinaci s vanovým napouštěním Exafill s odpadní a pře-padovou garniturou (viz strana 44)

Technické údaje

Provozní tlak:	max. 1 MPa
Doporučený provozní tlak:	0,1 - 0,5 MPa
Zkušební tlak:	1,6 MPa (1 MPa = 10 bar = 147 PSI)
Teplota horké vody:	max. 60°C
Rozteč připojení:	R _{3/4}
Připoje:	studená vpravo - teplá vlevo
Volný průtok při 0,3 MPa	
Sprchová armatura:	32 l/min
Termostat:	36 l/min
Termostat s uzavíracím ventilem:	26 l/min
Termostat s uzavíracím a přepínacím ventilem:	26 l/min
Termostat HighFlow (odpad 1 + 2):	58 l/min
iControl:	30 l/min
vanová baterie:	31 l/min // 24 l/min
Vanová baterie s integrovanou bezpečnostní kombinací:	25 l/min // 24 l/min





Hrubá montáž

- Rotačne symetrické základné teleso iBoxu je univerzálne použiteľné, horizontálne aj vertikálne. Neplatí pro montáž vanovej armatury s bezpečnostní kombinácií, zde je možná pouze vertikální montáž. Pretože v prípade poruchy funkčných častí môže začať z jednotky iBox vytekať voda, musí byť iBox namontovaný nad vaňou, ktorá vytekajúcu vodu odvedie.
- iBox je vhodný nielen pre vaňovú, ale aj pre sprchovú inštaláciu. Pri jednoručnej pákovej vaňovej batérii / termostate s uzatváracím a prestavovacím ventilom je prioritný spodný vývod. Ak sa vyžaduje iba jeden vývod, je možné voliteľne pripojiť horný alebo dolný vývod. Nepoužitý vývod sa musí utesniť zátkou.
- Veľké rozdiely v tlaku medzi prípojkami studenej a teplej vody musia byť vyrovnané.
- Základné teleso zabudovať tak, aby prívod teplej vody bol vľavo a prívod studenej vody vpravo.
- Montážna hĺbka: 80 mm až 108 mm.
- Predĺženie 25 mm
- Predĺženie 22 mm (pri malej montážnej hĺbke) pozrite si návod na montáž Vrchná sada

Základné teleso je montované podľa podmienok na stavbe podľa príkladov inštalácie vii strana 41 - 42.

- A** Inštalácia na stenu.
- B** Inštalácia pred stenu pomocou nastaviteľných 10 mm skrutiek.
- C** Montáž na nosný systém.
- D** Inštalácia na montážne platne prefabrikovanej konštrukcie alebo na hotové články.
- E** Inštalácia priamo do steny.
- F** Inštalácia so sadou montážnych lišt

Inštalčné príklady s uvedením rozmerov a výkonov nájdete od strany 34.

Montážne rozmery uvedené v návode na montáž sú ideálne pre osoby s výškou postavy približne 1800 mm a v prípade potreby je nutné ich prispôbiť. Pritom je nutné si uvedomiť, že pri zmenenej výške montáže sa mení minimálna výška a a je nutné dbať na rozmery rozmiestnenia prípojok. Hodnoty spotreby boli merané blízko praxe s príslušnými armatúrami (termostat/ zmiešavacia batéria/ventil pod omietku).

Montážny tip

Aby sa dali pripojovacie kusy dobre zatočiť, upne sa iBox pomocou trubkovej tvarovky do zverákú.

Prepláchnutie

Kompletná inštalácia podľa DIN 1988 / EN 1717. Šipky na umývacom bloku ukazujú, ktorý prívod je pripojený ku ktorému vývodu, napr. studená voda k hornému vývodu a teplá voda k dolnému vývodu. Ak je potrebný len jeden vývod, musí sa po prvom umývacom cykle otočiť umývací blok o 90°.

iBox kombinovaný s EXAFILL vaňovým napúšťaním s odpa- dovou a prepádovou garnitúrou (viď strana 44)

Technické údaje

Prevádzkový tlak:	max. 1 MPa
Doporučený prevádzkový tlak:	0,1 - 0,5 MPa
Skúšobný tlak:	1,6 MPa (1 MPa = 10 bar = 147 PSI)
Teplota teplej vody:	max. 60°C
Pripájacie rozmery:	R ^{3/4}
Prípoje:	studená vpravo - teplá vľavo
Volný prietok pri 0,3 MPa	
Sprchová batéria:	32 l/min
Termostatická batéria:	36 l/min
Termostatická batéria s uzatváracím ventilom:	26 l/min
Termostatická batéria s uzatváracou jednotkou a prestavovacím ventilom:	26 l/min
Termostatická batéria HighFlow (odtok 1 + 2):	58 l/min
iControl:	30 l/min
vaňová batéria:	31 l/min // 24 l/min
mešalna baterija za kopalno kad z vgrajeno varovalno kombinacijo:	25 l/min // 24 l/min





粗安装

- iBox的旋转对称基体可以作为万能部件使用, 在此只能垂直安装。始终在浴缸上面安装iBox。如果iBox零件即将断裂, 水可能从这里流出!
- iBox 用于安装面盆和花洒。对于带闭锁阀和切换阀的面盆手持龙头/恒温龙头, 优先使用下出水口。如果仅需一个出水口, 那么可以连接上出水或下出水。但另一个出水口必须用塞子封住。
- 冷热水管间过大的压力差必须予以平衡。
- 基体安装在热水连接装置左侧和冷水连接装置右侧。
- 安装深度: 80mm至108 mm。
- 加长 25 mm
- 加长件22mm (墙壁不够深时) 参见安装说明 加工件

根据构造的实际情况安装基体, 安装范例参见第 41 - 42 页。

- A** 直接墙面安装。
- B** 直接墙面安装, 带10 mm可调节的固定柱头螺栓。
- C** 安装在支柱上。
- D** 安装在预制装配式房屋——装配平台或预制装配式小室。
- E** 砖墙安装
- F** 使用固定组件安装

带数据和管道尺寸的安装实例请从 34 页起查找。本安装说明中所规定的安装尺寸理想用于身高 1800 mm 左右的人士。尺寸可根据需要进行修改。在这种情况下, 您必须留意, 如果安装高度改变, 则花洒到地板的最小高度也随之改变, 且必须考虑到连接尺寸的改变。已根据实际情况测量相关龙头 (恒温器/冷热水龙头/反水阀) 的消耗值。

安装提示

iBox通过管件在台虎钳内处理, 这样可以旋入连接件。

冲洗管系统

要完成安装, 冲洗冷热水供水管。水槽块上的箭头显示哪个进水口与哪个出水管相连, 例如, 冷水连接上方出水口, 热水连接下方出水口。如果只需要一个出口, 在第一次冲水后必须将水槽块旋转 90°。

iBox与下水部件组合, 配备出水组件及溢流组件 (参见第页 44)

技术参数

工作压力:	最大 1 MPa
推荐工作压力:	0,1 - 0,5 MPa
测试压强:	1,6 MPa
	(1 MPa = 10 bar = 147 PSI)
热水温度:	最大 60°C
中心距离:	R
连接管线:	左热右冷
	0,3 MPa时的流速:
淋浴龙头:	32 升/分钟
恒温龙头:	36 升/分钟
恒温龙头及闭锁单元:	26 升/分钟
恒温龙头及闭锁和分流器单元:	26 升/分钟
恒温龙头 HighFlow (出水口 1 + 2):	58 升/分钟
iControl:	30 升/分钟
浴缸—淋浴龙头:	31 升/分钟 // 24 升/分钟
浴缸淋浴龙头及整体式安全组合:	25 升/分钟 // 24 升/分钟



предварительный монтаж

- Вращательно-симметричный корпус iBox может использоваться универсально, как горизонтально, так и вертикально. Кроме монтажа арматуры ванны с комбинированным предохранителем здесь возможна только вертикальная установка. Поскольку при неисправности функциональных деталей у iBox может выходить вода, iBox необходимо монтировать над ванной, чтобы выступающая вода могла стекать в ванну!
- iBoxпредназначен для монтажа как ванн, так и душей. Для однорычажного смесителя для ванны / термостата с запорным и регулировочным клапаном преимущество имеет нижний отвод. Если нужен только один отвод, можно по выбору подключить верхний или нижний отвод. Неиспользуемый отвод нужно закрыть крышкой.
- донного клапа. Перед установкой смесителя необходимо регулировочными кранами выровнять авление холодной и горячей воды при помощи вентилей регулирующих подачу воды в квартиру.
- Установите корпус так, чтобы подключение горячей воды находилось слева, а холодной – справа.
- Глубина установки от 80 до 108 мм.
- Удлинение 25 мм
- Удлинение 22 мм (при малой глубине установки) см. инструкцию по монтажу Наружная часть

Корпус может монтироваться, согласно условиям строительства, примеры монтажа см. на стр. 41 - 42.

A варианты установки

B Установка на стене. Здесь с гибким распорным держателем, благодаря винтам 10.

C Монтаж на системе стоек.

D Установка на сборных монтажных плитах или сборных кабинках.

E монтаж в кирпичную стену

F Установка с помощью комплекта монтажных шин

Примеры монтажа с указанием размеров и размеры трубопровода см. на стр. 34.

Указанные в монтажной инструкции монтажные размеры идеальны для лиц ростом около 1800 мм. В случае необходимости монтажные размеры следует менять. При этом нужно учесть, что при изменившейся высоте монтажа меняется также и минимальная

высота, а изменение установочных размеров нужно принять во внимание. Расход измерен практически с помощью соответствующей арматуры (термостат/смеситель/скрытый клапан).

Подсказка по монтажу

Для завинчивания фитингов закрепите iBox с помощью куска трубы в тисках.

Промывка

Промывайте все установленное оборудование, согласно DIN 1988 / EN 1717. Стрелки на промывочном агрегате для мойки показывают, какой вход к какой выходной трубе подключен, например, холодная вода – к верхнему выходу, а горячая вода – к нижнему. Если требуется только одно выпускное отверстие, промывочный агрегат для мойки необходимо повернуть на 90° после запуска первого процесса промывки.

iBox в комбинации со впуском ванны Exafill со сливной и переливной гарнитурой (см. стр. 44)

Технические данные

Рабочее давление:	не более. 1 МПа
Рекомендуемое рабочее давление:	0,1 - 0,5 МПа
Давления:	1,6 МПа
	(1 МПа = 10 bar = 147 PSI)
Температура горячей воды:	не более. 60°C
Размеры подключения:	R ³ / ₄
Подключение:	холодная справа - горячая слева
Свободное истечение при 0,3 МПа:	
Смеситель душа:	32 л/мин
Термостат:	36 л/мин
Термостат с запорным вентилем:	26 л/мин
Термостат с запорным и переключающим вентилем:	26 л/мин
Термостат HighFlow (Выход 1 + 2):	58 л/мин
iControl:	30 л/мин
Смеситель ванны:	31 л/мин // 24 л/мин
Смеситель ванны со встроенным комбинированным предохранителем:	25 л/мин // 24 л/мин





Raaka-asennus

- Pyörösymmetrinen iBox:in peruskappale on yleiskäyttöinen, sen voi asentaa sekä pysty-, että vaakasuoraan. Poikkeuksena sellaisten ammearmatuurit, joissa on varmuuskombinaatio, tällöin vain vaakasuora asennus on mahdollinen. Koska iBox:ista voi valua vettä toimintaosien vahingoittuessa, iBox on asennettava ammeen yläpuolelle, jotta valuva vesi pääsee valumaan ammeeseen!
- iBox soveltuu sekä amme- että myös suihkuasennukseen. Alempi lähtö on tarkoitettu etupäässä yksikäsi ammesekoittimelle / termostaatile, jossa on sulku- ja vaihtoventtiili. Jos tarvitaan vain yksi lähtö, liittännän voi tehdä valinnaisesti ylempään tai alempaan lähtöön. Käyttämättä jäänyt lähtö on tiivistettävä sulkutulpalla.
- Suuret paine-erot kylmä- ja kuumavesiliitäntöjen välillä on tasattava.
- Asenna peruskappale siten, että lämminvesiliitäntä tulee vasemmalle ja kylmävesiliitäntä aina oikealle puolelle.
- Asennussyvyys 80 mm - 108 mm.
- Pidennys 25 mm
- Pidennys 22 mm (pienemmällä asennussyvyydellä) katso asennusohje Valmissarja

Peruskappaleen voi asentaa rakennuksen asettamien reunaehtojen mukaisesti, katso asennusesimerkkejä sivuilla 41 - 42.

- A** Asennus seinään
B Asennus seinään. Tässä joustavaa etäisyydenpitintä käyttäen kaksikierteisillä 10 mm ruuveilla.
C Asennus kannatinjärjestelmään
D Asennus valmistalojen asennuslevyihin tai valmisiisiin.
E Asennus suoraan seinään.
F Asennus käyttäen asennuskisko-sarjaa

Asennusesimerkit mittoineen ja putkietoimeen löytyvät alkaen sivulta 34.

Asennusohjeessa annetut asennusmitat sopivat n. 180 cm:n pituiselle henkilölle, ja niitä on tarvittaessa muutettava. Tässä on otettava huomioon, että asennuskorkeuden muuttuessa muuttuu myös vähimmäiskorkeus, ja muutos on otettava huomioon liitäntöjen mitoissa. Kulutusarvot on mitattu käytännöllä-heisesti kaikkine armatuureineen (termostaatti/sekoitin/seinäventtiili).

Asennusvihje

Kiinnitä iBox putkenpätkän avulla ruuvipenkkiin, jotta saat kierrettyä liittinkappaleet sisään.

Huuhtelu

Huuhtele koko asennus DIN 1988 / EN 1717 mukaisesti. Nuolet huuhtelulohkolla osoittavat mikä tulo on kytketty mihin lähtöjohtoon, esim. kylmä vesi ylempään lähtöön ja lämmin vesi alempaan lähtöön. Mikäli tarvitaan vain yksi lähtö, huuhtelulohkoa täytyy ensimmäisen huuhteluun jälkeen kääntää 90 °.

iBox yhdessä Exafill ammeentäytöhäna varustettuna tyhjennys- ja ylivuotovarusteilla (katso sivu 44)

Tekniset tiedot

Käyttöpaino:	maks. 1 MPa
Suosittelut käyttöpaino:	0,1 - 0,5 MPa
Koestuspaine:	1,6 MPa (1 MPa = 10 bar = 147 PSI)
Kuuman veden lämpötila:	maks. 60 °C
Liitäntämitat:	R ^{3/4}
Liittimet:	kylmä oikealla - kuuma vasemmalla
Vapaa läpivirtaus 0,3 MPa paineella:	
Suihkusekoittaja:	32 l/min
Termostaatti:	36 l/min
Termostaatti sulkuventtiilillä:	26 l/min
Termostaatti sulku- ja vaihtoventtiilillä:	26 l/min
Termostaatti HighFlow (Lähtö 1 + 2):	58 l/min
iControl:	30 l/min
Ammesekoittaja:	31 l/min // 24 l/min
Ammesekoittaja integroidulla turvayhdistelmällä:	25 l/min // 24 l/min



Grundmontering

- Den rotations-symmetriska grundkonstruktionen hos iBox är universellt användbar, så väl horisontellt som vertikalt. Detta gäller dock inte för monteringen av karamatur med säkerhetskombination; här är endast vertikal montering möjlig. Eftersom vatten kan tränga ut vid iBoxen om funktionsdelar är defekta så måste iBoxen monteras över karet så att det vatten som kommer ut kan rinna ner i karet!
- IBox är avsedd för såväl kar- som duschinstallation. Till engreppsblandare / termostat med spärr- och omställningsventil används främst det undre avloppet. Om endast ett avlopp behövs kan antingen det övre eller undre avloppet anslutas. Det avlopp som inte behövs skall tätas med en plugg.
- Stora tryckskillnader mellan anslutningarna för varmt och kallt vatten måste utjämnas.
- Montera grundkonstruktionen så att varmvattensanslutningen sitter till vänster och kallvattensanslutningen till höger.
- Monteringsdjup 80 mm till 108 mm.
- Förlängning 25 mm
- Förlängning 22 mm (vid litet monteringsdjup) se monteringsbeskrivning Färdigset

Grundkonstruktionen monteras enligt de förutsättningar som gäller på platsen, se monterings exempel på sidor 41 - 42.

- A** Vägginstallation.
- B** Vägginstallation. Här med flexibel avståndshållare genom skruvstift storl. 10.
- C** Montering på stödsystem.
- D** Installation på monteringsplattor till färdighus eller färdigsektioner.
- E** Installation direkt i väggen.
- F** Installation med monteringskneset

Du hittar installationsexempel med uppgifter om mått och ledningsdimensioner från sidan 34.

De monteringsmått som anges i monteringsanvisningen passar 1,80 m långa personer och måste eventuellt anpassas. Det är då viktigt att tänka på att den minsta höjden ändras när monteringshöjden blir en annan och att hänsyn måste tas till de ändrade anslutningsmåten. Förbrukningsvärdena uppmättes under användning med de tillhörande armaturerna (termostat/blandare/infälld ventil).

Monteringstips

Sätt fast iBox i skruvvingen med hjälp av ett rör när anslutningsstycken ska skruvas in.

Spola

Spola igenom hela installationen enligt DIN 1988 / EN 1717. Pilarna på spolblocket visar vilket inlopp som är anslutet till vilken utloppsledning, t.ex. kallt vatten med det övre utloppet och varmt vatten med det nedre utloppet. Om endast ett utlopp behövs, måste spolblocket vridas 90° efter den första spolningen.

iBox i kombination med ett Exafill karinlopp med från- och överrinningsset (se sidan 44)

Tekniska data

Driftstryck:	max. 1 MPa
Rek. driftstryck:	0,1 - 0,5 MPa
Tryck vid provtryckning:	1,6 MPa (1 MPa = 10 bar = 147 PSI)
Varmvattentemperatur:	max. 60°C
Anslutningsmått:	R ^{3/4}
Anslutningar:	kallt höger - varmt vänster
Fri genomströmning vid 0,3 MPa:	
Duschblandare:	32 l/min
Termostat:	36 l/min
Termostat med spärrventil:	26 l/min
Termostat med spärr- och omställningsventil:	26 l/min
Termostat HighFlow (Avlopp 1 + 2):	58 l/min
iControl:	30 l/min
Karblandare:	31 l/min // 24 l/min
Karblandare med integrerad säkerhetskombination:	25 l/min // 24 l/min





Bazinis montavimas

- Simetriškai besisukantis iBox pagrindą galima įstatyti tiek horizontaliai, tiek vertikaliai. Kai įrengiama vonios armatūra su apsauginiu rinkiniu, įmontuoti galima tik vertikaliai. iBox visada montuokite virš vonios, kad atsiradus problemai su funkcinėmis dalimis, vanduo galėtų į ją nubėgti!
- iBox tinka tiek voniai, tiek ir dušui. Viena ranka valdomuose maišytuvuose / termostatuose su uždarymo vožtuvais ir skirstytuvais pirmenybė teikiama apatiniam išvadui. Jei reikalingas tik vienas išvadas, galite uždengti apatinį arba viršutinį išvadą. Nereikalingą išvadą sandariai uždenkite kaiščiu.
- Turi būti išlyginti šalto ir karšto slėgio nelygumai.
- Pagrindą sumontuokite taip, kad karšto vandens jungtis būtų kairėje, o šalto - dešinėje.
- Montavimo gylis: nuo 80 mm iki 108 mm.
- Ilgiklis 25 mm
- Ilgiklis 22 mm (esant nepakankamam sienos gyliui) žr. montavimo instrukciją Virštininė

Pagrindą galite sumontuoti pagal vietos sąlygas, montavimo pavyzdžiai pateikti 41 - 42 psl.

A Montavimas į sieną.

B Montavimas į sieną su specialiais reguliuojamais 10 mm varžtais.

C Montavimas prie laikančios sistemos.

D Montavimas prie namo montavimo plokščių arba elementų.

E Montavimas į sieną.

F Montavimas su montavimo rinkiniu

Įrengimo pavyzdžiai su nurodytais matmenimis ir vamzdyno dydžiais pateikti 34 puslapyje.

Montavimo instrukcijoje nurodyti išmatavimai idealiai tinka 1800 mm ūgio žmonėms. Galima keisti aukštį, bet tuomet keičiasi minimalus rekomenduojamas patalpos aukštis ir turi būti atsižvelgta į vandens jungties matmenų pasikeitimą. Sąnaudos išmatuotos artimomis realioms sąlygomis su reikiamomis dalimis (termostatu / maišytuvu / potinkiniu čiaupu).

Monatavimo patarimas

Norėdami įsukti jungiamuosius elementus, vamzdžius įtvirtinkite iBox spaustuvuose.

Išplaukite

Išplaukite pagal DIN 1988 / EN 1717. Rodyklės ant plautuvės bloko rodo, kuriuos įvadus ir išvadų vamzdžius reikia sujungti tarpusavyje, pavyzdžiui, šalto vandens įvadą su viršutiniu išvadą, o karšto vandens įvadą su apatiniu išvadą. Jei reikia tik vieno išvado, po pirmojo plovimo plautuvės bloką reikia apsukti 90°.

iBox kartu su Exafill vonios čiaupu ir išleidimo bei apsauginės angos rinkiniais (žr. psl. 44)

Techniniai duomenys

Darbinis slėgis:	ne daugiau kaip 1 MPa
Rekomenduojamas slėgis:	0,1 - 0,5 MPa
Bandomasis slėgis:	1,6 MPa (1 MPa = 10 barų = 147 PSI)
Karšto vandens temperatūra:	ne daugiau kaip 60°C
Atstumas tarp centrų:	R ³ / ₄
Prijungimas:	Šaltas vanduo dešinėje, karštas - kairėje
Laisvas vandens pralaidumas esant 0,3 MPa slėgiui:	
dušo maišytuvais:	32 l/min
Termostatas:	36 l/min
Termostatas su uždarymo vožtuvu:	26 l/min
Termostatas su uždarymo vožtuvu ir skirstytuvu:	26 l/min
Termostatas HighFlow (Ištekėjimas 1 + 2):	58 l/min
iControl:	30 l/min
maišytuvais voniai:	31 l/min // 24 l/min
maišytuvais voniai su integruota apsaugos sistema:	25 l/min // 24 l/min



Pripremna montaža

- Rotacijsko simetrično tijelo jedinice iBox je univerzalno primjenjivo, kako horizontalno tako i vertikalno. Iznimku predstavlja montaža armatura za kade sa sigurnosnom kombinacijom, kod koje je moguća samo vertikalna ugradnja. Budući da kod kvara pojedinih dijelova iz iBox-a može otjecati voda, iBox je potrebno instalirati iznad kade kako bi voda mogla otjecati u kadu!
- IBox je pogodan za ugradnju na tuš kade i kade. Kod jednoručnih miješalica za kade / termostata s ventilom za zatvaranje i ventilom selektora prioritetan je donji izlaz. Ako je potreban samo jedan ispuš, po izboru se može priključiti gornji ili donji izlaz. Izlaz koji se ne koristi mora se zatvoriti čepom.
- Velika razlika u pritisku između vruće i hladne vode mora biti izbalansirana.
- Montirajte tijelo tako da se priključak tople vode nalazi na lijevoj, a hladne na desnoj strani.
- Dubina ugradnje 80 - 108 mm.
- Produljenje 25 mm
- Produljenje 22 mm (kod manje dubine ugradnje) vidi upute za montažu Završni set

Tijelo se može montirati u skladu s uvjetima koji vladaju na mjestu postavljanja, primjeri montaže mogu se naći na stranicama 41 - 42.

- A** Direktna instalacija u zid.
- B** Direktna instalacija u zid sa 10 mm podesivim vijcima
- C** Montaža na sustav nosača.
- D** Instalacija na gotove montažne ploče ili gotove ćelije.
- E** Instalacija u zid od cigle.
- F** Instalacija sa setom instalacijskih udloga

Primjeri instalacija s veličinama i dimenzijama vodova mogu se naći od stranice 34 nadalje.

Montažne dimenzije navedene u uputama za montažu idealne su za osobe visine oko 1800 mm te se prema potrebi moraju prilagoditi konkretnoj visini korisnika. Pritom valja uzeti u obzir da se u slučaju promjene montažne visine mijenja i minimalna visina kao i da se tada mora uvažiti i promjena priključnih dimenzija. Vrijednosti potrošnje u praksi mjerene su s pripadajućim armaturama (termostat/mješač/podžbukni ventil).

Savjet u vezi montaže

Za uvrtnje priključnih elemenata iBox treba zategnuti u stegu uz pomoć komada cijevi.

Ispiranje

Kompletnu instalaciju treba isprati sukladno DIN 1988 / EN 1717. Strelice na bloku prikazuju koji je dovod spojen s kojim odvodom, npr. hladna voda s gornjim, a topla s donjim odvodom. Ako je potreban samo jedan odvod, onda se nakon prvog ispiranja blok mora zakrenuti za 90°.

iBox u kombinaciji s Exafill ispuštom u kadu s odvodnom i preljevnom garniturom (pogledaj stranicu 44)

Tehnički podatci

Najveći dopušteni tlak:	tlak 1 MPa
Preporučeni tlak:	0,1 - 0,5 MPa
Probni tlak:	1,6 MPa
	(1 MPa = 10 bar = 147 PSI)
Temperatura vruće vode:	tlak 60°C
Razmak od sredine:	R ³ / ₄
Spojevi:	hladna desno - topla lijevo
Slobodan protok na 0,3 MPa:	
Mješalica tuša:	32 l/min
Termostat:	36 l/min
Termostat sa izolacijskim ventilom:	26 l/min
Termostat sa ventilom za zatvaranje i ventilom selektora:	26 l/min
Termostat HighFlow (izlaz 1 + 2):	58 l/min
iControl:	30 l/min
Mješalica za kadu:	31 l/min // 24 l/min
Mješalica za kadu sa ugrađenim sigurnosnim sustavom:	25 l/min // 24 l/min





Instalare brută

- Partea principală simetric-rotațională a iBox-ului poate fi introdusă oricum, atât orizontal cât și vertical. Excepție la montarea robinetului căzii cu combinația de protecție, în acest caz este posibilă numai montarea pe verticală. Din cauza posibilității de defectare a componentelor din iBox, montați instalația iBox deasupra căzii pentru ca apa scursă să se evacueze prin cadă.
- Cutia iBox este corespunzătoare atât pentru instalarea căzilor cât și a dușurilor. În cazul amestecătorului monomanual pentru cadă / termostat cu ventil de închidere și valvă comutator, este prioritară ieșirea inferioară. Dacă se necesită doar o singură ieșire, puteți racorda în funcție de necesități ieșirea inferioară sau cea superioară. Ieșirea nefolosită trebuie etanșată cu o garnitură de etanșare.
- Diferențele de presiune mari între alimentarea cu apă rece și apă caldă trebuie echilibrate.
- Corpul de bază este astfel construit încât racordul pentru apa caldă se află în partea stângă, iar cel pentru apa rece, în dreapta.
- Adâncime de montare 80 - 108 mm
- Prelungitor 25 mm
- Prelungitor 22 mm (în cazul montării la adâncime mică) vezi instrucțiunile de montare Set complet

Corpul de bază se poate monta în funcție de condițiile existente, ca exemplu de montare, vedeți pagina 41 - 42.

- A** Montare pe perete.
- B** Montare pe perete. Cu distanțieri flexibili și țije filetate de 10 mm cu diblu.
- C** Montare pe sistem de susținere.
- D** Instalare pe plăci de montare în case prefabricate sau în compartimente prefabricate.
- E** Montare direct pe perete.
- F** Montare cu set de șine de montare

Exemple de montaj cu specificații referitoare la dimensiuni și capacitate se găsesc începând de la pagina 34.

Dimensiunile de montare din instrucțiunile de montare sunt ideale pentru persoane cu o înălțime de cca. 1800 mm și trebuie modificate dacă este cazul. Aici trebuie să țineți cont de modificarea înălțimii de montare,

deoarece în acest caz se va modifica și înălțimea minimă de montare și astfel trebuie modificate toate dimensiunile de racordare. Rile de consum au fost măsurate pe teren cu armăturile corespunzătoare (termostat, robinet de amestecare, supapă sub tencuială).

Indicații pentru montaj

Pentru înșurubarea piesei de racordare, cutia iBox este prevăzută cu o piesă tubulară strânsă în locașul filetat.

Clătire

Clătiți toată instalația conform DIN 1988 / EN 1717. Săgețile de pe blocul de spălare, arată cum se face racordarea la conductele de ieșire, spre ex. apa rece la ieșirea superioară și apa caldă la ieșirea inferioară. În cazul în care este utilizată numai o singură ieșire, blocul de spălare trebuie rotit cu 90° după prima spălare.

Cutie iBox în combinație cu Exafill pe intrarea în cadă, cu un set pentru evacuare și deversare.
(vezi pag. 44)

Date tehnice

Presiune de funcționare:	max. 1 MPa
Presiune de funcționare recomandată:	0,1 - 0,5 MPa
Presiune de verificare:	1,6 MPa (1 MPa = 10 bar = 147 PSI)
Temperatura apei calde:	max. 60°C
Interax racorduri:	R ^{3/4}
Racorduri:	rece - dreapta / cald - stânga
Debit cu curgere liberă la 0,3 MPa:	
Baterie duș:	32 l/min
Termostat:	36 l/min
Termostat cu ventil de închidere:	26 l/min
Termostat cu ventil de închidere și valvă comutator:	26 l/min
Termostat HighFlow (Evacuare 1 + 2):	58 l/min
iControl:	30 l/min
baterie pentru cadă de baie:	31 l/min // 24 l/min
Baterie pentru cadă de baie cu combinație de siguranță integrată:	25 l/min // 24 l/min



Εγκατάσταση

- Το συμμετρικό σώμα περιστροφής του iBox μπορεί να χρησιμοποιηθεί παντού, οριζόντια και κατακόρυφα. Εξαιρείται η συναρμολόγηση της μπαταρίας μηχανίρας με συνδυασμό ασφαλείας, εδώ είναι εφικτή μόνο η κατακόρυφη εγκατάσταση. Σε περίπτωση βλάβης των λειτουργικών τμημάτων, μπορεί να εξέρχεται νερό από το iBox, και θα πρέπει η μονάδα iBox να συναρμολογηθεί πάνω από την μπανιέρα, προκειμένου το εξερχόμενο νερό να ρέει μέσα στην μπανιέρα στην περίπτωση αυτή.
- Το iBox είναι κατάλληλο για εγκατάσταση τόσο σε μπανιέρες όσο και σε ντουζιέρες. Σε αναμικτήρες μπανιέρας με μία λαβή / θερμοστάτη με βαλβίδα κλεισίματος και εκτροπής, προτεραιότητα έχει η κάτω εξαγωγή. Εάν είναι απαραίτητη μόνο μία εξαγωγή, μπορεί να συνδεθεί ανάλογα η άνω ή κάτω εξαγωγή. Η εξαγωγή που δεν θα χρησιμοποιείται πρέπει να ταπώνεται με τάπα.
- Οι διαφορές της πίεσης μεταξύ της σύνδεσης κρύου και ζεστού νερού θα πρέπει να αντισταθμίζονται.
- Τοποθετήστε τη βασική εγκατάσταση έτσι ώστε η σύνδεση ζεστού νερού να βρίσκεται αριστερά και του ψυχρού δεξιά.
- Βάθος τοποθέτησης 80 - 108 mm.
- Επιμήκυνση 25 mm
- Σωλήνας επιμήκυνσης 22 mm (σε μειωμένο βάθος τοποθέτησης) βλ.επε Οδηγίες συναρμολόγησης Σετ μηχανισμού

Η βασική εγκατάσταση μπορεί να τοποθετηθεί σύμφωνα με τα δεδομένα του χώρου, παραδείγματα εγκατάστασης βλ.επε σελίδα 41 - 42.

- A** Επίτοιχη τοποθέτηση
- B** Επίτοιχη εγκατάσταση. Χρησιμοποιήστε 10 άρες βίδες -καρφιά με εύκαμπτα στηρίγματα.
- C** Συναρμολόγηση επί φέροντος συστήματος.
- D** Εγκατάσταση σε πλάκες συναρμολόγησης προκατασκευασμένων οικιών ή προκατασκευασμένες κυψέλες.
- E** Εγκατάσταση απευθείας στον τοίχο
- F** Εγκατάσταση με σετ σιδηροτροχιών συναρμολόγησης

Παραδείγματα εγκατάστασης με διαστάσεις και διαστασιολόγηση των σωλήνων θα βρείτε από τη σελίδα 34.

Οι διαστάσεις που αναφέρονται στις οδηγίες συναρμολόγησης είναι ιδανικές για άτομα με ύψος περ. 1800 mm και πρέπει, εάν χρειαστεί, να προσαρμοστούν. Στη φάση αυτή προσέξτε ότι με την αλλαγή του ύψους συναρμολόγησης τροποποιείται και το απαιτούμενο ελάχιστο ύψος, οπότε θα προκύψει αλλαγή και στις διαστάσεις σύνδεσης. Οι τιμές κατανάλωσης μετρήθηκαν στην πράξη με τα ανάλογα εξαρτήματα μπαταρίας (θερμοστάτης/αναμικτήρας/εντοχιωμένη βαλβίδα).

Συμβουλή για την εγκατάσταση

Για να βιδώσετε τεμάχια σύνδεσης, σφίξτε το iBox με ένα τεμάχιο σωλήνα στη μέγγενη.

Καθαρισμός

Καθαρισμός πλήρους εγκατάστασης σύμφωνα με το πρότυπο EN 1717. Τα βέλη στο μπλοκ του νεροχύτη δείχνουν ποια είσοδος συνδέεται με ποιον σωλήνα εξόδου, π.χ. κρύο νερό στην επάνω έξοδο και ζεστό νερό στην κάτω έξοδο. Εάν απαιτείται μόνο μία έξοδος, το μπλοκ του νεροχύτη πρέπει να στρέφεται κατά 90° μετά την πρώτη έκπλυση.

iBox σε συνδυασμό με είσοδο νερού μπανιέρας Exafill με απορροή και εξοπλισμό υπερχειλίσης (βλ.

Σελίδα 44)

Τεχνικά Χαρακτηριστικά

Λειτουργία πίεσης:	έως 1 MPa
Συνιστώμενη λειτουργία πίεσης:	0,1 - 0,5 MPa
Πίεση ελέγχου:	1,6 MPa (1 MPa = 10 bar = 147 PSI)
Θερμοκρασία ζεστού νερού:	έως 60°C
Διαστάσεις σύνδεσης:	R ^{3/4}
Συνδέσεις:	κρύο δεξιά - ζεστό αριστερά
Ελεύθερη ροή στα 0,3 MPa:	
Μπαταρία (μείκτης) καταιονιστήρα:	32 l/min
Θερμοστάτης:	36 l/min
Θερμοστάτης με βαλβίδα κλεισίματος:	26 l/min
Θερμοστάτης με βαλβίδα κλεισίματος και εκτροπή:	26 l/min
Θερμοστάτης HighFlow (Έξοδος 1 + 2):	58 l/min
iControl:	30 l/min
Μπαταρία μπανιέρας:	31 l/min // 24 l/min
Μπαταρία μπανιέρας με ενσωματωμένο συνδυασμό ασφαλείας:	25 l/min // 24 l/min





Surova montaža

- Rotacijsko simetrično osnovno telo valja iBox je univerzalno vstavljivo, tako vodoravno kot tudi navpično. Izjema je le montaža armature za kopalno kad z zaščitnim kompletom, kjer je možna le navpična vgradnja. Pri okvari delov iBoxa lahko pride do izteka vode, zato iBox montiramo nad kadijo. Tako lahko voda odteka v kad!
- iBox je primeren tako za instalacije za kopalne kadi kot tudi za prhe. Pri enoročnih baterijah za kopalno kad / termostatu z zapornim in preklopnim ventilom ima prednost spodnji odvod. Če potrebujete le en odvod, lahko po izbiri priključite zgornji ali spodnji odvod. Neuporabljen odvod zatesnite s čepom.
- Velike razlike v tlaku med priključkom za mrzlo in priključkom za toplo vodo je potrebno izravnati.
- Osnovno telo vgradite tako, da se priključek za toplo vodo nahaja na levi, priključek za hladno vodo pa na desni strani.
- Globina vgradnje 80 do 108 mm
- Podaljšek 25 mm
- Podaljšek 22 mm (če zid ni dovolj globok) glejte Navodilo za montažo Zaključna garnitura

Osnovno telo se lahko montira ustrezno gradbenim pogojem, montažne primere glejte na strani 41 - 42.

- A** Montaža na steno
- B** Montaža na steno. Tukaj z upogljivim distančnikom in 10-milimetrskimi vijaki.
- C** Montaža na nosilnem sistemu.
- D** Instalacija na plošče montažne hiše ali montažne celice.
- E** Montaža direktno v steno
- F** Montaža s pritrilnim kompletom

Inštalacijske primere z navedbami mer in dimenzioniranjem cevi najdete od strani 34 dalje.

V navodilu za montažo navedene mere so idealne za osebe, visoke pribl. 1800 mm, in jih je treba po potrebi prilagoditi. Pri tem morate paziti na to, da se pri spremenjeni montažni višini spremeni tudi minimalna višina in je treba upoštevati spremembo priključnih mer. Vrednosti porabe so bile s pripadajočimi armaturami (termostat/mešalni ventil/podometni ventil) izmerjene v pogojih, ki ustrezajo predvideni dejanski uporabi.

Nasvet za montažo

Za uvitje priključnih kosov iBox s pomočjo kosa cevi vpnite v primež.

Izpiranje

Kompletno instalacijo imperite v skladu z DIN 1988 / EN 1717. Puščice na splakovalnem bloku kažejo, kateri dovod je priključen na kateri odvodni vod, npr. hladna voda z zgornjim iztokom in topla voda s spodnjim iztokom. Če je potreben samo en izpust, je treba splakovalni blok po prvem postopku splakovanja obrniti za 90°.

iBox v kombinaciji z Exafill dovodom za kopalno kad z odtočno in pretočno garnituro (glejte stran 44)

Tehnični podatki

Delovni tlak:	maks. 1 MPa
Priporočeni delovni tlak:	0,1 - 0,5 MPa
Preskusni tlak:	1,6 MPa
	(1 MPa = 10 bar = 147 PSI)
Temperatura tople vode:	maks. 60°C
Razdalja od sredine:	R ³ / ₄
Priključki:	mrzla desno - topla levo
Prost pretok pri 0,3 MPa:	
Mešalna baterija za prho:	32 l/min
Termostat:	36 l/min
Termostat z zapornim ventilom:	26 l/min
Termostat z zapornim in preklopnim ventilom:	26 l/min
Termostat HighFlow (Odvod 1 + 2):	58 l/min
iControl:	30 l/min
Mešalna baterija za kad:	31 l/min // 24 l/min
Mešalna baterija za kad z vgrajeno varnostno kombinacijo:	25 l/min // 24 l/min



Toormontaaž

- Iboxi sümmeetrilise ringlusega põhikorpus on universaalselt kasutatav, nii horisontaalselt kui vertikaalselt. Välja arvatud turvakombinatsiooniga vannisegisti paigaldamisel, mille puhul on võimalik ainult vertikaalne paigaldamine. Paigaldage iBox alati vanni kohale. Kui iBox'i osad lähevad katki, võib vesi vanni voolata!
- iBox sobib niihästi vanni kui ka duši paigaldamiseks. Ühekäe-vannisegisti / katkestus- ja ümberlülitusklapiga termostaat puhul on alumine väljavool prioriteetne. Kui on vaja vaid ühte väljavoolu, saab soovi korral ülemise või alumise väljavoolu sulgeda. Mittevajalik väljavool tuleb korgiga tihendada.
- Kui külma ja kuumaa vee ühenduste surve on väga erinev, tuleb need tasakaalustada.
- Põhikorpus paigaldada nii, et sooja vee liitmik oleks vasakul ja külma vee liitmik paremal.
- Paigalduse sügavus 80 mm kuni 108 mm
- pikendus 25 mm
- pikendus 22 mm (kui sein ei ole piisavalt paks) vt paigaldamisjuhendit Valmiskomplekt

Põhikorpus on võimalik paigaldada vastavalt ehituslikele asjaoludele, näiteid paigaldamise kohta vt lk 41 - 42.

- A** Seinale paigaldamine.
- B** Seinale paigaldamine. Siin reguleeritava vahehooldikuga, kasutades 10 mm tikkpolte.
- C** Kandursüsteemile paigaldamine.
- D** Paigaldamine valmismaja seinaplaatidele või lisamoodulitele
- E** Paigaldamine otse seinale.
- F** Paigaldamine kinnitussiinidega

Paigaldusnäited koos mõõtude info ja voolikute suurustega leiate alates lehiküljelt 34.

Paigaldusjuhendis esitatud paigaldusmõõdud on ideaalsed u. 1800 mm pikkustele inimestele ning vajadusel tuleb neid kohandada. Seejuures tuleb silmas pidades, et muutunud paigalduskõrguse korral muutub ka minimaalne kõrgus ning tuleb arvestada, et erinevad on ka ühendusmõõdud. Tarbimisväärtusi mõõdeti praktikas juurdekuuluvate segistitega (termostaat/segisti/süvisklapp).

Paigaldusnäpunäide

Ühendusdetailide sissekeeramiseks kinnitage iBox toru abil kruustangidesse.

Äravoolu süsteem

Paigalduse lõpetamiseks uhuge läbi sooja ja külma vee varustus. Loputusplokkil olevad nooled näitavad, milline sisend on millise väljalasketoruga ühendatud, nt külm vesi ülemise väljalaskeava ja kuum vesi alumise väljalaskeava. Kui on vaja ainult ühte väljalaskeava, tuleb loputusplokki pärast esimest loputusprotsessi 90° pöörata.

iBox ühenduses ära- ja ülevoolu-garnituuriga Exafilli vanni sisse-vooluga (vt lk 44)

Tehnilised andmed

Töörõhk	maks. 1 MPa
Soovitav töörõhk:	0,1 - 0,5 MPa
Kontrollsurve:	1,6 MPa
	(1 MPa = 10 baari = 147 PSI)
Kuumaa vee temperatuur:	maks. 60°C
distants keskelt:	R ^{3/4}
ühendused:	külm paremal, kuum vasakul
Äravoolu surve 0,3 MPa	
dušisegisti:	32 l/min
Termostaat:	36 l/min
Katkestusklapiga termostaat:	26 l/min
Katkestus- ja ümberlülitusklapiga termostaat:	26 l/min
Termostaat HighFlow (väljavool 1 + 2):	58 l/min
iControl:	30 l/min
Vanni-duši segisti:	31 l/min // 24 l/min
Turvasüsteemiga vanni-duši segisti:	25 l/min // 24 l/min





Cauruļu montāža

- Rotācijā simetrisks iBox korpusis ir izmantojams universāli - gan horizontāli, gan vertikāli. Izņemot gadījumus, kad veic vannas maisītāja montāžu ar drošības kombināciju - šādos gadījumos iespējama tikai vertikāla iebūve. Tā kā funkcionālo detaļu bojājuma gadījumā no iBox daļas var izplūst ūdens, iBox jāmontē virs vannas, lai izplūstošais ūdens varētu notecēt vannā!
- iBox ir piemērots gan vannu, gan dušu instalācijām. Vannas jaucekļkrāniem ar vienu sviru / termostatiem ar noslēgvārstu un pārslēdzējvārstu apakšējai izplūdes ierīcei ir prioritāte. Ja ir nepieciešama tikai viena izplūdes ierīce, ar pēc izvēles pieslēgt augšējo vai apakšējo izplūdes ierīci. Neizmantotā izplūdes ierīce jānoblīvē ar aizbāzni.
- Jāizlīdzina spiediena atšķirības starp aukstā un karstā ūdens pievadiem.
- Korpusu iebūvējiet tā, lai siltā ūdens pieslēgums atrastos pa kreisi un aukstā ūdens pieslēgums - pa labi.
- Iebūvēšanas dziļums 80 mm līdz 108 mm.
- Pagarinājums 25 mm
- Pagarinājums 22 mm (ja iebūvēšanas dziļums nav pietiekams) skatīt montāžas instrukciju Komplekts

Korpusu iespējams iebūvēt atbilstoši konstrukcijas īpašībām, montāžas piemērus skat. 41 - 42. lpp.

A Instalācija pie sienas.

B Instalācija pie sienas. Šeit ar elastīgu starpliku un 10 mm izmēra montāžas skrūvēm.

C Montāža uz balstu sistēmu.

D Instalācija uz gatavām ēku montāžas platēm vai gatavām kabinēm.

E Instalācija tieši sienā.

F Instalācija ar montāžas sliežu komplektu

Uzstādīšanas piemēri ar izmēriem un vadu izkārtojumu atrodami, sākot no 34 lappuses.

Montāžas instrukcijās dotie montāžas izmēri ir ideāli piemēroti personām, kuru augums ir apm. 1800 mm. Nepieciešamības gadījumā šie izmēri ir jāpielāgo. Šeit ir jāņem vērā, ka mainoties montāžas augstumam, mainās arī minimālais augstums, un jāņem vērā arī pieslēgšanas izmēru izmaiņas. Patērētājam ir jānorāda praksē ar atbilstošu maisītāju (termostats/jaucējkārs/zemapmetuma vārsts).

Montāžas padoms

Lai iegrieztu savienojuma elementus, iBox ar caurules palīdzību nostipriniet skrūvspilēs.

Skalošana

Izskalojiet visu instalāciju atbilstoši DIN 1988 / NE 1717.Bulītiņas uz skalošanas bloka norāda, kurš pievads ir savienots ar attiecīgo izplūdes cauruli, piem., aukstais ūdens ar augšējo izplūdi un siltais ūdens ar apakšējo izplūdi. Ja nepieciešama tikai viena izplūde, pēc pirmās skalošanas reizes skalošanas bloks jāpagriež par 90°.

iBox kombinācijā ar Exafill vannas ieklūdi ar noplūdes un pārplūdes garnitūru (skat. lpp. 44)

Tehniskie dati

Darba spiediens:	maks. 1 MPa
leteicamais darba spiediens:	0,1 - 0,5 MPa
Pārbaudes spiediens:	1,6 MPa
	(1 MPa = 10 bar = 147 PSI)
Karstā ūdens temperatūra:	maks. 60°C
Pieslēguma izmēri:	R3/4
Pieslēgumi:	aukstais pa labi - karstais pa kreisi
Brīva caurplūde, ja ir 0,3 MPa:	
Dušas jaucekļkrāns:	32 l/min
Termostats:	36 l/min
Termostats ar slēgvārstu:	26 l/min
Termostats ar noslēgvārstu un pārslēdzējvārstu:	26 l/min
Termostats HighFlow (Izteka 1 + 2):	58 l/min
iControl:	30 l/min
Vannas/ dušas jaucekļkrāns:	31 l/min // 24 l/min
Vannas/ dušas jaucekļkrāns ar integrētu drošības kombināciju:	25 l/min // 24 l/min



Pripremna montaža

- Rotaciono simetrično telo jedinice iBox je univerzalno primenljivo, kako horizontalno tako i vertikalno. Izuzetak predstavlja montaža armatura za kade sa sigurnosnom kombinacijom, jer je tu moguća samo vertikalna ugradnja. Pošto kod kvara pojedinih delova iz iBox-a može isticati voda, iBox se mora instalirati iznad kade, tako da voda može oticati u kadu!
- iBox je pogodan za ugradnju na tuš i instalaciju za kade. Kod jednoručnih mešača za kadu / termostata s ventilom za zatvaranje i preklonim ventilom prioritetan je donji izlaz. Ukoliko je potreban samo jedan ispust, po izboru može da se priključi gornji ili donji izlaz. Izlaz koji se ne koristi mora da se zatvori čepom.
- Velika razlika u pritisku između vruće i hladne vode mora biti izbalansirana.
- Montirajte telo tako da priključak tople vode bude sa leve, a hladne sa desne strane.
- Dubina ugradnje 80 - 108 mm.
- Produžetak 25 mm
- Produžetak 22 mm (kod manje dubine ugradnje) vidi uputstvo za montažu Završni set

Telo može da se montira u skladu sa uslovima na mestu ugradnje, za primere montaže vidi strane 41 - 42.

- A** Direktna instalacija na zid.
- B** Direktna instalacija na zid s držačem odstojanja pomoću 10 mm podesivih zavrtnja.
- C** Montaža na sistem nosača.
- D** Instalacija na gotove montažne ploče ili gotove ćelije.
- E** Instalacija direktno u zid.
- F** Instalacija sa setom instalacionih šina

Primeri instalacija sa veličinama i dimenzijama vodova mogu se naći od stranice 34 nadalje.

Montažne dimenzije navedene u uputstvu za montažu idealne su za osobe visine oko 1800 mm, tako da se po potrebi moraju prilagoditi konkretnoj visini korisnika. Pri tome treba uzeti u obzir da se prilikom promene montažne visine menja i minimalna visina kao i da se u tom slučaju mora uvažiti i promena priključnih dimenzija. Vrednosti potrošnje su u praksi merene sa pripadajućim armaturama (termostat/mešač/uzidni ventil).

Savet u vezi montaže

Za uvrtnje priključnih elemenata iBox treba zategnuti u stegu uz pomoć komada cevi.

Ispiranje

Kompletnu instalaciju treba isprati u skladu s DIN 1988 / EN 1717. Strelice na bloku prikazuju koji je dovod spojen sa kojim odvodom, npr. hladna voda sa gornjim, a topla sa donjim odvodom. Ukoliko je potreban samo jedan odvod, onda se nakon prvog ispiranja blok mora zakrenuti za 90°.

iBox u kombinaciji sa Exafill dotokom kade sa odvodnom i prelivnom garniturom (vidi stranu 44)

Tehnički podaci

Radni pritisak:	maks. 1 MPa
Preporučeni radni pritisak:	0,1 - 0,5 MPa
Probni pritisak:	1,6 MPa
	(1 MPa = 10 bar = 147 PSI)
Temperatura vruće vode:	maks. 60°C
Rastojanje između centara priključaka:	R ³ / ₄
Priključci:	hladna voda desno - topla levo
Slobodan protok na 0,3 MPa:	
Mešač tuša:	32 l/min
Termostat:	36 l/min
Termostat s ventilom za zatvaranje:	26 l/min
Termostat s ventilom za zatvaranje i preklonim ventilom:	26 l/min
Termostat HighFlow (izlaz 1 + 2):	58 l/min
iControl:	30 l/min
Mešač za kadu:	31 l/min // 24 l/min
Mešač za kadu s ugrađenim sigurnosnim sistemom:	25 l/min // 24 l/min



Råmontasje

- Det rotasjonsymetriske basiselementet til iBox kan brukes universelt dvs. horisontalt og vertikalt. Et unntak er ved montasje av kararmatur ved sikkerhetskombinasjon. Da er det kun mulig med vertikal montasje. Ettersom det kan lekke vann ut av iBoxen ved en defekt, skal iBoxen monteres over badekaret, slik at vannet som lekker ut kan renne ned i badekaret.
- iBoxen egner seg både for installasjon på dusj eller badekar. Ved enhånd-blandebatteri for badekar / termostat med sperre- og omstillingsventil prioriteres nedre utgangen. Dersom kun en utgang brukes, kan det valgfritt kobles til øvre eller nedre utgang. Utgangen som ikke brukes må tettes med en plugg.
- Store trykkdifferanser mellom kaldt- og varmtvannstilkoblinger skal utlignes.
- Basiselementet bygges inn slik at varmtvannstilkobling er på venstre og kaldtvannstilkobling er på høyre side.
- Innbyggingsdybde 80 mm til 108 mm.
- Forlengelse 25 mm
- Forlengelse 22 mm (ved liten montasje dybde) se montasjeveiledning Ferdigsett

Innbyggingsdelen kan monteres iht. byggmessige forhold, se montasje-eksempel på side 41 - 42.

- A** Installasjon på vegg
- B** Installasjon på vegg. Her med fleksible avstandsholdere via spesialskruer.
- C** Montasje på bæresystem.
- D** Installasjon på ferdighus-montasjeplater eller ferdigceller.
- E** Installasjon rett på vegg.
- F** Installasjon med sett av montajeskiner

Installasjonseksempel med målanger og ledningsdimensjoner finns fom. side 34.

Monteringsmål i monteringsveiledningen er beregnet for personer som er omtrent 1800 mm høye, målene skal eventuell tilpasses om nødvendig. Her skal man passe på at ved endrede monteringsmålene blir minstehøyden endret, og det må tas hensyn til de endrede tilkoblingsmålene. Forbruksverdiene måles ved normal bruk med tilhørende armatur (temostat/blandebatteri/innmurt ventil).

Montasje-tipp

For å skru inn koblinger skal iBoxen settes fast i en skrustikke ved hjelp av et rør.

Spyle

Komplett installasjon spyles iht. DIN 1988 / EN 1717. Pilene på skylleblokken viser hvilken tilførselslange som er tilkoblet hvilken tømme-lange, f.eks kaldtvann med øvre utløp og varmtvann med nedre utløp. Hvis kun ett utløp er nødvendig, må skylleblokken dreies 90° etter første skylleprosess.

iBox i kombinasjon med Exfill karinnløp med avløps- og overflyt-garnityr (se side 44)

Tekniske data

Driftstrykk	maks. 1 MPa
Anbefalt driftstrykk:	0,1 - 0,5 MPa
Prøvetrykk	1,6 MPa
	(1 MPa = 10 bar = 147 PSI)
Varmtvannstemperatur	maks. 60°C
Tilkoblingsmål:	R ^{3/4}
Tilkoblinger:	kaldt høyre - varm venstre
Fri gjennomstrømning ved 0,3 MPa:	
Dusj-blandebatteri:	32 l/min
Termostat:	36 l/min
Termostat med sperreventil:	26 l/min
Termostat med sperre- og omstillingsventil:	26 l/min
Termostat HighFlow (Utgang 1 + 2):	58 l/min
iControl:	30 l/min
Blandebatteri for badekar:	31 l/min // 24 l/min
Blandebatteri for badekar med integrert sikkerhetskombinasjon:	25 l/min // 24 l/min





Първичен монтаж

- Ротационно-симетричното основно тяло на iBox може да се приложи универсално, хоризонтално и вертикално. Изключение прави монтажът на арматурата за вана с комплект предпазители, тук е възможен само вертикален монтаж. Тъй като при дефект на функционалните части около iBox може да изтече вода, iBox трябва да се монтира над ваната, за да може изтичащата вода да се отича във ваната!
- iBox е подходяща както за инсталации на вани, така и на разпръскватели. При смесители за вана с една ръкохватка / термостат със спирателен и превключващ клапан първостепенен е долният извод. Ако е необходим само един извод може да бъде свързан по избор горният или долният извод. Излишният извод може да се уплътни с пробка.
- Големите разлики в налягането между изводите за студената и топлата вода трябва да се изравняват.
- Основното тяло се монтира така, че изводът за топла вода да се намира отляво, а за студена вода отдясно.
- Монтажна дълбочина 80 мм до 108 мм.
- Удължител 25 мм
- Удължител 22 мм (при малка монтажна дълбочина) вижте ръководството за монтаж Готов набор

Основното тяло може да се закрепни на стената в съответствие с конструктивните дадености, примери за монтаж на стр. 41 - 42.

- A** Инсталация на стената.
- B** Инсталация на стената. Тук с гъвкава разпънка с помощта на комбинирани болтове 10.
- C** Монтаж на трегерната система.
- D** Инсталация на монтажни плочи на сглобяеми сгради или готови клетки.
- E** Инсталация директно в стената.
- F** Инсталация с набор монтажни шини

Примери за инсталация с данни за размери и определяне на размерите на тръбопроводите можете да намерите от стр. 34 нататък.

Посочените в ръководството за монтаж монтажни мерки са идеални за лица с ръст от пригл. 1800 мм

и трябва съответно да се пригледят. При това обърнете внимание на това, при променена монтажна височина се променя минималната височина и трябва да бъде взета под внимание промяната на присъединителните размери. Стойностите за разхода бяха измерени във връзка с практиката със съответните арматури (термостат/смесител/клапан за полагане в мазилката).

Съвети при монтаж

За да завинтите присъединителните елементи затегнете iBox с помощта на тръбен елемент в менюта.

Промиване

Промийте цялата инсталация съгласно DIN 1988 / EN 1717. Стрелките върху промивачия блок показват кой вход към кой изход е свързан, например студена вода с горния изход и топла вода с долния изход. В случай, че е необходим само един изход, след първия процес на промиване промивачият блок трябва да бъде завъртан на 90°.

iBox в комбинация с вход за вана Exafill с гарнитура за изтичане и преливане. (вижте стр. 44)

Технически данни

Работно налягане:	макс. 1 МПа
Препоръчително работно налягане:	0,1 - 0,5 МПа
Контролно налягане:	1,6 МПа
	(1 МПа = 10 bar = 147 PSI)
Температура на горещата вода:	макс. 60°C
Присъединителни размери:	R ³ / ₄
Изводи:	студено отдясно – топло отляво
Свободен поток при 0,3 МПа:	
Смесител на разпръсквателя:	32 л/мин
Термостат:	36 л/мин
Термостат със спирателен клапан:	26 л/мин
Термостат със спирателен и превключващ клапан:	26 л/мин
Термостат HighFlow (Извод 1 + 2):	58 л/мин
iControl:	30 л/мин
Смесител за вана:	31 л/мин // 24 л/мин
Смесител на вана с интегриран комплект предпазители:	25 л/мин // 24 л/мин





仮施工

- iBox本体は90度ごとの対称形状なので、水平または垂直の特定の向きを気にする必要はありません。バキュームブレーカー付製品を利用する際は、垂直に取り付けてください(日本国内では適用されません)。部品に不具合がある場合はiBoxから水が漏れる可能性があるため、iBoxは浴槽の上部に施工して、水が漏れても浴槽内に排水されるようにしてください!
- iBoxは、バス/バウトとシャワーの両方(または1つ)への吐水にご利用いただけます。止水機能と切替(ダイバーター)バルブを持つシングルレバー/サーモスタットバス・シャワー混合栓では、下側の取出口を主に使用するよう施工にしてください。1つの取出口のみ使う場合は、器具と接続をしない取出口はプラグで止水をしてください。
- 給水・湯の圧力差は0.1(MPa)以内としてください。
- お湯が左側に、水が右側になるように、本体を施工します。
- 施工深さ80 mmから108 mm。
- 25 mm延長部材
- 22 mm延長部材(壁裏が浅い場合) 施工説明書をご覧ください 化粧部

埋込部は取付状況に合わせた様々な施工が可能です(施工例については次のページを参照 41 - 42)。

- A** 壁への施工。
B 壁への施工。ここでは、10本のハンガーボルトと特殊金具を使用します。
C 取付け架台への施工。
D プレハブ住宅パネルまたはユニットバスへの施工。
E 壁への直接施工。
F レールセットでの施工
- 寸法と配管サイズを含む施工例は、ページ34から掲載されています。

施工説明書に記載の施工寸法例は、身長約1800 mmの方のご利用を想定しています。必要に応じて変更をしてください。施工寸法を変更する場合、必要クリアランスなど関連する他の寸法への影響を十分考慮して下さい。流量は、適切な組み合わせで使用される製品(サーモスタット/ミキサー/埋込水栓)とセットで測定されています。

施工のアドバイス

iBoxに仮付けしたパイプを万力で固定して、配管部材を取り付けます。

配管洗浄

DIN 1988 / EN 1717に準拠する配管洗浄をして下さい(日本においては、配管洗浄を確実に実施して下さい)。水洗ブロックの矢印は、どの注入口がどの排出管に接続されているかを示しています(例: 冷水は上の排出口へ、温水は下の排出口へ)。コンセンツトが1つだけ必要な場合は、最初のすすぎ後にすすぎブロックを90°回転させる必要があります。

排水およびオーバーフロー付のエクサフィル(Exafill)とiBoxの組み合わせ(次のページを参照 44)

技術資料

使用圧力:	最大 1 MPa
推奨使用水圧:	0,1 - 0,5 MPa
耐圧試験圧力:	1,6 MPa
	(1 MPa = 10 bar = 147 PSI)
給湯温度:	最大 60°C
接続寸法:	R ^{3/4}
接続:	湯左・水右
0.3 MPaで何も接続しない時の流量:	
シャワー混合水栓:	32 リットル/分
サーモスタット混合栓:	36 リットル/分
止水付サーモスタット混合栓:	26 リットル/分
止水・切替付サーモスタット混合栓:	26 リットル/分
サーモスタット混合栓	
HighFlow (吐水用取出口 1 + 2):	58 リットル/分
iControl:	30 リットル/分
バス・シャワ	
一混合水栓:	31 リットル/分 // 24 リットル/分
逆流防止装置付バス・シャワ	
一混合水栓:	25 リットル/分 // 24 リットル/分





Прихований монтаж

- Обертально-симетричний основний корпус iBox можна використовувати універсально, як горизонтально, так і вертикально. Винятком є встановлення арматури для ванни з комбінацією безпеки, тут можлива лише вертикальна установка. Завжди встановлюйте iBox над ванною. Якщо частини iBox будуть зламані, вода може злитися туди!
- iBox підходить як для ванн, так і для душів. При використанні змішувача для ванни-душу/термостатичного змішувача із запірним і розподільним виходом, нижній вихід повинен мати пріоритет. Якщо вам потрібна лише один вихід, виберіть верхній або нижній вихід та підключіть його. Закрийте невикористаний вихід заглушкою.
- Гаряча і холодна подачі води повинні мати однаковий тиск.
- Встановіть корпус так, щоб подача гарячої води була зліва, а подача холодної води – справа.
- Глибина посадки: 80 мм до 108 мм.
- подовження 25 мм
- Набір подовження 22 мм (якщо стіна недостатньо глибока) див. інструкції зі встановлення Фінішний набір

Базовий набір може бути встановлений різними способами відповідно до конструктивних умов.

Приклади встановлення див. на сторінках 41 - 42.

A Прямий настінний монтаж.

B Пряме встановлення на стіну за допомогою регульованих монтажних шпильок 10 мм.

C Установка на носійну систему.

D Установка на збірні монтажні пластини або збірні комірці.

E Монтаж безпосередньо в стіну.

F Монтаж з комплектом кріплення

Приклади монтажу з вимірюваннями та розмірами труб можна знайти, починаючи зі сторінки 34.

Розміри встановлення, зазначені в цій інструкції зі встановлення, ідеально підходять для людей із зростом приблизно 1800 мм. При необхідності розміри можна змінити. У цьому випадку зверніть увагу на те, що зміна монтажної висоти змінить мінімальну висоту; також слід враховувати змінені монтажні розміри.

Споживання було виміряно в поєднанні з відповідною

арматурою (термостат/змішувач/внутрішній клапан), щоб відобразити фактичне застосування на практиці.

Підказка щодо встановлення

Щоб встановити відповідні труби, закріпіть iBox трубою в лещатах.

Промивна система трубопроводів

Для завершення монтажу промийте як гаряче, так і холодне водопостачання. Стрілки на промивальному блоці вказують, який вхід пов'язаний з яким відводом, напр., холодна вода з верхнім відводом, а гаряча вода – з нижнім відводом. Якщо буде потрібний лише один відвід, після першої процедури промивання промивальний блок потрібно повернути на 90°.

iBox у поєднанні з наповнювачем для ванн Emaxfill з переливом і зливом (дивіться сторінку 44)

Технічні дані

Робочий тиск:	макс. 1 МПа
Рекомендований робочий тиск:	0,1 - 0,5 МПа
Випробувальний тиск:	1,6 МПа
	(1 МПа = 10 бар = 147 PSI)
Температура гарячої води:	макс. 60°C
Розміри підключення:	R ³ / ₄
З'єднання:	холодний праворуч - гарячий ліворуч
Витрата на 0,3 МПа:	
Змішувач для душу:	32 л/хв
Термостатичний змішувач:	36 л/хв
Термостатичний змішувач з блоком відключення:	26 л/хв
Термостатичний змішувач із запірним і перехідним блоком:	26 л/хв
Термостатичний змішувач HighFlow (Вихід 1 + 2):	58 л/хв
iControl:	30 л/хв
Змішувач для ванни-душу:	31 л/хв // 24 л/хв
Змішувач для ванни-душу з вбудованою системою безпеки:	25 л/хв // 24 л/хв





تركيب الأنابيب

ويمكن تغيير الأبعاد عند الحاجة وبالتالي سيتغير الحد الأدنى للارتفاع في حالة تغيير ارتفاع التركيب، مما يعني الأخذ في الاعتبار تغيير أبعاد التوصيل. تم قياس قيم الاستهلاك طبقاً للخبرة العملية في استعمال خلاطات المياه الخاصة بذلك (ثرموستات/خلاط/صمام تحت الملائم).

نصائح خاصة بعملية التركيب

من أجل لف الوصلات، يجب تركيب وحدة "iBox" في الملمزة باستخدام أنبوبة.

نظام سريان الماء عبر المواسير

لإكمال التركيب، قم بفتح المياه الساخنة والباردة لتحديد الأسهم الموجودة على وحدة الغسل أي وصلة تغذية بالمياه ترتبط بأي وصلة صرف، على سبيل المثال: المياه الباردة مع وصلة الصرف العليا، والمياه الساخنة مع وصلة الصرف السفلي. إذا كانت هناك حاجة إلى وصلة صرف واحدة فقط، فيجب تدوير وحدة الغسل بعد أول استخدام لها بنسبة 90 درجة.

وحدة "iBox" مع وحدة التدفق بالحوض من النوع "Exafill" مع لوازيم تصريف الماء وتصريف تدفق المياه. (راجع صفحة 44)

المواصفات الفنية

ضغط التشغيل: الحد الأقصى 1 ميغاباسكال
 ضغط التشغيل الموصى به: 0,1 - 0,5 ميغاباسكال
 ضغط الاختبار: 1,6 ميغاباسكال
 (1 ميغاباسكال = 10 بار = 147 PSI)
 درجة حرارة الماء الساخن: الحد الأقصى 60°C
 المسافة المركزية: 3/4R
 الوصلات: الماء البارد جهة اليمين - الماء الساخن جهة اليسار
 معدل تدفق 0,3 ميغاباسكال:

32 لتر / الدقيقة خلاط الدش:
 36 لتر / الدقيقة ثرموستات:
 26 لتر / الدقيقة ثرموستات متصل بصمام غلق:
 ثرموستات متصل بصمامات غلق وتحويل:
 26 لتر / الدقيقة ثرموستات HighFlow (مخرج 1 + 2): 58 لتر / الدقيقة
 Control: 30 لتر / الدقيقة
 خلاط دش الحمام: 31 لتر / الدقيقة //
 24 لتر / الدقيقة
 لا ط دش الحمام بمجموعة أمان مدمجة:
 25 لتر / الدقيقة // 24 لتر / الدقيقة

- يتم استخدام الجسم الرئيسي ذيو الدوران المتماثل للوحدة "iBox" في جميع أنحاء العالم سواء بصورة أفقية أو رأسية. إلا أنه لا يمكن القيام بالتركيب إلا بصورة رأسية في هذه الحالة إلا في حالة تركيب لوازيم الحوض باستخدام تركيبية الأمان. احرص دوماً على تركيب iBox فوق حوض الاستحمام (البانيو). إذا تعرضت أجزاء من iBox للكسر، فربما يتسبب ذلك في تسرب المياه في كل مكان!
- تعد وحدة "iBox" ملائمة لتركيب حوض الاستحمام أو الدش. وفي حالة استخدام خلاط بالحوض بصنبور واحد فقط / ثرموستات متصل بصمام غلق وتحويل، يفضل استخدام الصرف السفلي. إذا كانت هناك حاجة لصرف واحد فقط يمكن حسب الرغبة اختيار الصرف العلوي أو السفلي. يجب سد المنفذ غير المستخدم عن طريق سدادة.
- يجب أن يكون تيار الماء الساخن والماء البارد متعادلين في الضغط.
- قم بتركيب الجسم الرئيسي للوحدة بصورة ملائمة بحيث توجد وصلة المياه الساخنة في الجانب الأيسر ووصلة المياه الباردة في الجانب الأيمن.
- عمق التركيب: من 80 مم حتى 108 مم.
- وصلة إطالة 25 مم
- طقم الملحقات 22 مم (عندما لا يكون الجدار عميقاً بما يكفي) أنظر دليل التركيب مجموعة كاملة.
- يمكن تركيب الجسم الرئيسي للوحدة وفقاً لظروف البناء، انظر أمثلة التركيب صفحتي 41 - 42.
- A** التركيب على حائط مباشر
- B** التركيب على الحائط المباشر بجوايب تركيب قابلة للضبط طولها 10 مم.
- C** التركيب على نظام حمامات.
- D** التركيب على لوحات التركيب للمنازل الجاهزة البناء أو على الخلايا الجاهزة.
- E** التركيب على حائط من الطوب
- F** التركيب باستخدام طقم التثبيت
- يوجد بدءاً من صفحة 34 أمثلة للتركيب بمقاسات وطرق عمل بعض الوصلات.
- تعد أبعاد التركيب الواردة في إرشادات التركيب هذه مثالية بالنسبة للأشخاص الذين يبلغ طولهم حوالي 1800 مم



Ham montaj

- iBox'un rotasyon simetrik ana gövdesi yatay veya dikey şekilde çok amaçlı kullanılabilir. İstisna: Emniyet kombinasyonlu batarya armatürünün montajı sırasında sadece dikey montaj mümkündür. Fonksiyon parçalarının arızalanması durumunda iBox'tan su çıkabileceği için, dışarı çıkan suyun küvete akabilmesi için iBox küvetin üzerine monte edilmelidir.
- iBox hem küvet hem de duş tesisatı için uygundur. Tek elli küvet tipi bataryalarda / kesme ve divertör valfli termostatta alt çıkış önceliklidir. Sadece tek bir çıkış gerekiyorsa tercihen üst veya alt çıkış bağlantılabilir. Gerekmeyen çıkış bir tapa ile contalanmalıdır.
- Sıcak ve soğuk su bağlantıları arasında büyük basınç farklılıkları varsa, bu basınç farklılıklarının dengelenmesi gerekir.
- Ana gövdeyi, sıcak su bağlantısı solda ve soğuk su bağlantısı sağda olacak şekilde takın.
- Montaj derinliği 80 mm ila 108 mm.
- Uzatma 25 mm
- Uzatma 22 mm (montaj derinliği düşüktükçe) Montaj talimatına bakın Dışı set

Ana gövde yapısal koşullara uygun şekilde takılabilir, Montaj örneği Bkz. Sayfa 41 - 42.

A Duvara direkt montaj

B Duvara direkt montaj. Burada, esnek mesafe tutucuları ile 10'lu sıkma vidaları kullanılarak.

C Taşıyıcı sistem üzerine montaj.

D Hazır ev montaj plakalarına veya hazır hücrelere kurulum.

E Tuğla duvar Montajı

F Montaj rayı setiyle montaj

Ölçü verileri ve hat boyutlandırıcılı tesisat örnekleri Sayfa 34 itibarıyla bulunabilir.

Montaj kılavuzunda belirtilen montaj ölçüleri, yaklaşık 1.800 mm boyundaki kişiler için idealdir ve gerekirse adapte edilmelidir. Bu sırada, montaj yüksekliğinin değişmesiyle birlikte minimum yüksekliğin de değiştiğine ve bağlantı ölçülerindeki değişikliğin göz önüne alınması gerektiğine dikkat edilmelidir. Tüketim değerleri uygulamalı olarak ilgili armatürlerle (termostat/ karıştırıcı/sıva altı valf) ölçülmüştür.

Montaj önerisi

Bağlantı parçalarını vidalamak için, iBox'u bir boru parçasıyla mengeneyle sabitleyin.

Yıkama

DIN 1988 / EN 1717'ye göre komple tesisatı yıkayın. Yıkama vanasındaki oklar hangi girişin hangi çıkış hattına bağlı olduğunu gösteriyor, örn. soğuk su üst çıkış ile ve sıcak su alt çıkış ile. Eğer sadece bir çıkışa ihtiyaç duyuluyorsa, ilk yıkama işleminden sonra yıkama vanası 90° döndürülmelidir.

Çıkış ve taşma aksesuarlı bir Exa-fill batarya girişiyle bağlantılı iBox (bakınız sayfa 44)

Teknik bilgiler

İşletme basıncı:	azami 1 MPa
Tavsiye edilen işletme basıncı:	0,1 - 0,5 MPa
Kontrol basıncı:	1,6 MPa (1 MPa = 10 bar = 147 PSI)
Sıcak su sıcaklığı:	azami 60°C
Bağlantı ölçüleri:	R ^{3/4}
Bağlantılar:	soğuk sağ - sıcak sol
0,3 MPa serbest akış:	
Duş miks bataryası:	32 l/dak
Termostat:	36 l/dak
Kesme valfli termostat:	26 l/dak
Kesme ve divertör valfli termostat:	26 l/dak
Termostat HighFlow (Çıkış 1 + 2):	58 l/dak
iControl:	30 l/dak
Küvet miks bataryası:	31 l/dak // 24 l/dak
Entegre emniyet kombinasyonlu küvet miks bataryası:	25 l/dak // 24 l/dak



Garanti Belgesi

Üretici veya İthalatçı Firmanın

Unvanı:

Adresi:

Telefonu:

Faks:

web adresi:

Hansgrohe Armatür Ltd. Şti
Fulya Mahallesi Bahçeler Sokak Efe han 20/C
Mecidiyeköy Şişli İstanbul
(0-212) 273 07 30
(0-212) 273 07 40
www.hansgrohe.com.tr

Malın

Markası:

Cinsi:

Garanti Süresi:

Azami Tamir Süresi:

Hansgrohe
Sihhi tesisat malzemesi
2 YIL
20 İş günü

Genel Müdür

Albert Emlek

Satıcı Firmanın:

Unvanı:

Adresi:

Telefonu:

Faks:

e-posta:

Fatura Tarih ve Sayısı:

Marka ve Modeli:

Teslim Tarihi ve Yeri:

Yetkilinin İmzası:

Firmanın Kaşesi:

Bu bölümü, ürünü aldığınız Yetkili Satıcı imzalayacak ve kaşeleyecektir.





Csőszerelés

- Az iBox szimmetrikus rotációjú belső szerelékével együtt univerzálisan – vízszintesen és függőlegesen egyaránt – elhelyezhető. A biztonsági szerelvényvel ellátott kádcsaptelep kivételével, itt csak a függőleges beépítés lehetséges. Mivel a működő részek meghibásodásakor víz kerülhet az iBox-ra, ezért az iBox-ot a kád fölé kell felszerelni, hogy a kifolyó víz a kádba folyhasson!
- Az iBox kádhoz és tusolóhoz egyaránt alkalmas. Egykaros kádcsaptelep / elzáró- és váltószeleppel rendelkező termosztát esetében az alsó kiállás az elsődleges. Ha csak egy kiállásra van szükség, akkor tetszés szerint a felső vagy az alsó kiállást lehet csatlakoztatni. A használaton kívüli kiállást vakdugóval kell lezárni.
- A hidegvíz- és a melegvíz-csatlakozások közötti nagy nyomáskülönbséget kikell egyenliteni!
- Az alaptestet úgy szereljük be, hogy a melegvíz csatlakozása bal oldalra, míg a hidegvíz csatlakozása jobb oldalra kerüljön.
- Beépítési mélység: 80 – 108 mm
- Hosszabbítás 25 mm
- Hosszabító készlet 22 mm (kis beépítési mélység esetén) lásd a szerelési útmutatót A kész szerelvény

Az alaptestet az építészeti adottságoknak megfelelően szereljük be. A szerelési példákat lásd a 41 - 42. oldalon.

- A** Szerelés közvetlenül a falra.
- B** Távtartó szerkezetre való szerelés.
- C** Tartórendszerre szerelés.
- D** Készház elemre vagy előkészített elemre szerelés.
- E** Szerelés falba süllyesztve.
- F** Szerelés szerelősin-szettel

Felszerelési példák méreteikkel és vezeték- dimenzionálással az 34 oldaltól kezdődően található.

A szerelési útmutatóban megadott szerelési méretek kb. 1800 mm testmagasságú személyeknek alkalmasak, és ennek megfelelően átméretezendők. Itt arra kell ügyelni, hogy az átméretezett szerelési magasságnál megváltozik a minimális magasság és figyelembe kell venni a csatlakozó méreteinek változását. A fogyasztási értékeket, a gyakorlathoz közel álló módon, a hozzátartozó csaptelepekkel (termosztát/keverő csaptelep/vakolat alatti szelep) mértük.

Szerelési ötlet

A csatlakozó közdarabok becsavarásához - egy cső segítségével - fogjuk satuba az iBox-ot.

Átöblítés

A DIN 1988 / EN 1717 szerint öblítse át a komplett installációt. Az öblítőblokkon lévő nyílak azt jelzik, hogy melyik beömlő vezeték melyik lefolyó vezetékhez kapcsolódik, így pl. a hidegvíz vezetéke az felső kiálláshoz és a melegvíz vezetéke az alsó kiálláshoz. Amennyiben csupán egyetlen kiállásra van szükség, az első öblítési műveletet követően forgassa el 90°-kal az öblítő-blokkot.

iBox, valamint Exafill kádtöltő, le- és túlfogyó kombinációja (lásd a oldalon 44)

Műszaki adatok

Üzemi nyomás:	max. 1 MPa
Ajánlott üzemi nyomás:	0,1 - 0,5 MPa
Nyomáspróba:	1,6 MPa (1 MPa = 10 bar = 147 PSI)
Forróvíz hőmérséklet:	max. 60°C
Csatlakozási méret:	R ³ / ₄
Csatlakozás:	hideg jobbra - meleg balra
Szabad átfolyás 0,3 MPa nyomás esetén:	
Zuhanycsaptelep:	32 l/perc
Termosztát:	36 l/perc
Termosztát elzárószeleppel:	26 l/perc
Termosztát elzáró- és váltószeleppel:	26 l/perc
Termosztát HighFlow (Kifolyó 1 + 2):	58 l/perc
iControl:	30 l/perc
Kádcsaptelep:	31 l/perc // 24 l/perc
Kádcsaptelep beépített biztonsági egységgel:	25 l/perc // 24 l/perc





התקנה נסתרת

- גוף הסיבוב הסימטרי מאפשר שימוש במצב אנכי ואופקי. במקרה של התקנת סוללת האמבטיה-מקלחת עם התקן בטיחות משולב, אפשר להתקין התקנה אנכית בלבד התקן תמיד את iBox מעל האמבטיה. אם חלקים של iBox נשברים, מים יוכלו לחדור פנימה
- יחידת iBox מתאימה לשימוש גם באמבטיה וגם במקלחת. כששתמשים בסוללת ברז תרמוסטטי / סוללת אמבטיה - מקלחת עם ניתוק ויציאת הסטה, ליציאה התחונה צריכה להיות קדימות. אם דרושה יציאה אחת בלבד, בחר ביציאה העליונה או התחתונה וחבר אותה. פקוק את היציאה שאין בה צורך
- למערכת המים החמים והקרים צריכים להיות לחצים שווים

- התקן את הגוף עם אספקת מים חמים משמאל ואספקת מים קרים מימין
- עומק התקנה: 80 מ"מ עד 108 מ"מ
- הארכה 25 מ"מ
- סט הארכה 22 מ"מ (כשהקיר עמוק מספיק) ראה הוראות התקנה סט גימור

אפשר להתקין את הסט הבסיסי בדרכים שונות, בהתאם לאופן הבנייה. לדוגמאות להתקנה ראה עמוד 41 - 42

- A** התקנה ישירה על קיר
- B** התקנה ישירה על קיר עם בורגי הרכבה מתכוננים 10 מ"מ
- C** התקנה על מערכת נושאת
- D** התקנה על גבי לוחות התקנה טרומיים או תקרות מוגמרות
- E** התקנה על קיר לבנים (בריקים)
- F** התקנה עם סט הידוק

דוגמאות התקנה עם מידות ומידות צינורות אפשר למצוא החל מעמוד 34

מידות ההתקנה המצוינות בהוראות ההתקנה הללו הן אידיאליות לאנשים בגובה של כ-1.80. אפשר לשנות את המידות, אם רוצים. במקרה כזה, צריך לשים לב ששינוי בגובה ההתקנה ישנה גם את גובה המינימום, וצריך לקחת בחשבון את מידות ההתקנה המעודכנות. הצריכה נמדדה בשילוב עם האביזרים המתאימים (תרמוסטט/מנגנון ערבוב מים/ברז בקיר) כדי לשקף את המצב בפועל

המלצה להתקנה

כדי להתקין את צינורות האספקה, התקן את iBox עם צינור במלחציים

שטוף את מערכת הצינורות

כדי להשלים את ההתקנה, שטוף את אספקת המים החמים והקרים החיצים שעל הכיור מציגים איזה פתח כניסה מחובר לאיזה צינור יציאה, לדוגמה מים קרים עם פתח היציאה העליון ומים חמים עם פתח היציאה התחתון. אם יש צורך בפתח יציאה אחד בלבד, יש לסובב את הכיור ב-90° לאחר השטיפה הראשונה.

iBox בשילוב עם אביק ופיית מילוי Exafill (ראה עמוד 44)

נתונים טכניים

לחץ הפעלה: MPa 1 מקסימום
 לחץ פעולה מומלץ: MPa 0,5 - 0,1
 לחץ בדיקה: MPa 1,6

(MPa = 10 bar = 147 PSI 1)
 טמפרטורת מים חמים: מקסימום 60°C
 מרחק המרכז: ¼R
 חיבורים: קרים ימין - חמים שמאל

קצב זרימה על פי MPa 0,3:

זרוע מקלחת: 32 ליטר לדקה
 ברז תרמוסטטי: 36 ליטר לדקה
 ברז תרמוסטטי עם יחידת ניתוק: 26 ליטר לדקה
 ברז תרמוסטטי עם יחידת ניתוק והסטה: 26 ליטר לדקה
 ברז תרמוסטטי HighFlow (יציאה 1 + 2): 58 ליטר לדקה
 iControl: 30 ליטר לדקה
 סוללת אמבטיה-מקלחת: 31 ליטר לדקה // 24 ליטר לדקה
 סוללת אמבטיה-מקלחת עם יחידת בטיחות משולבת: 25 ליטר לדקה // 24 ליטר לדקה



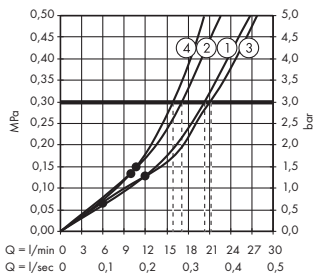
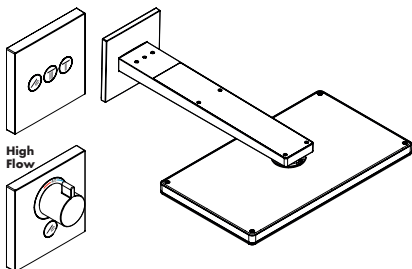

[www.hansgrohe.com/
installation-examples](http://www.hansgrohe.com/installation-examples)

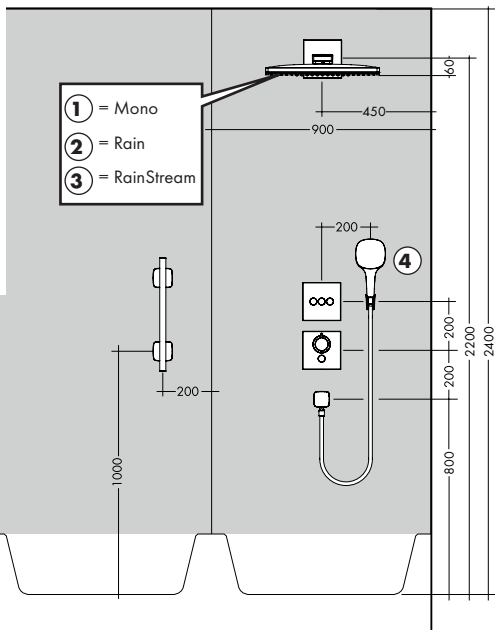

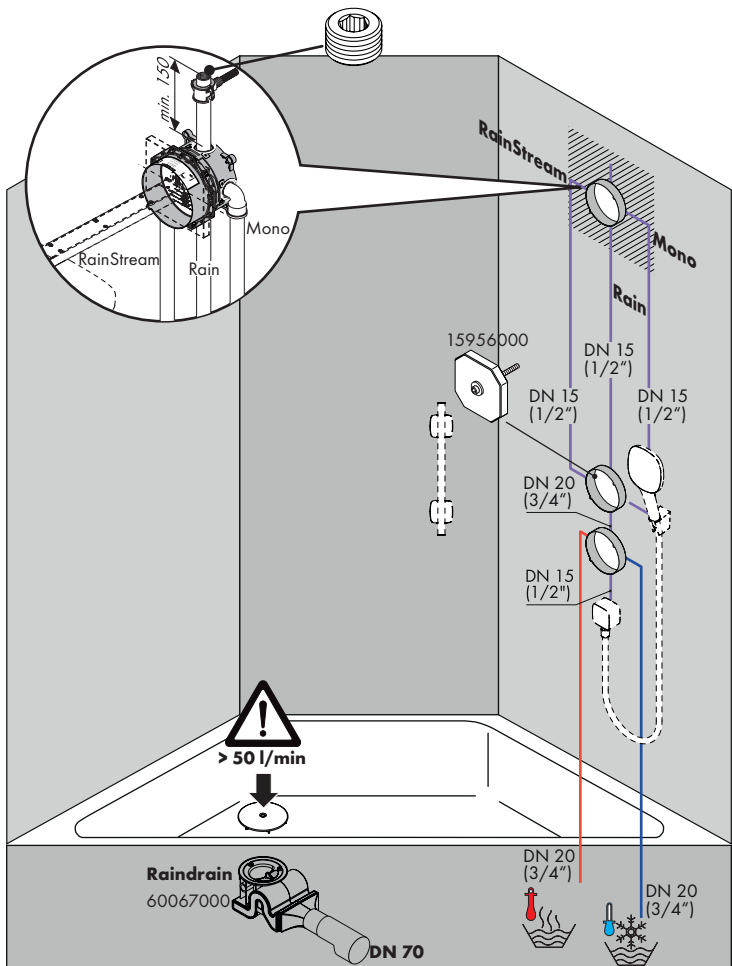

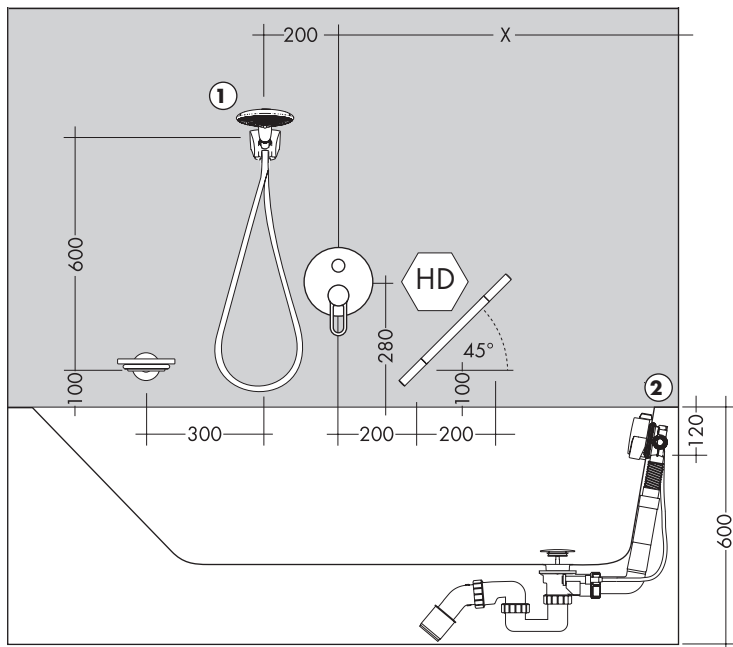
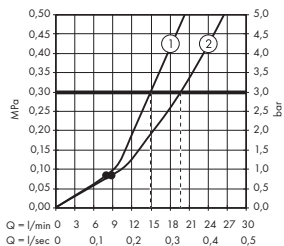
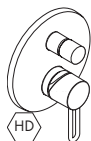

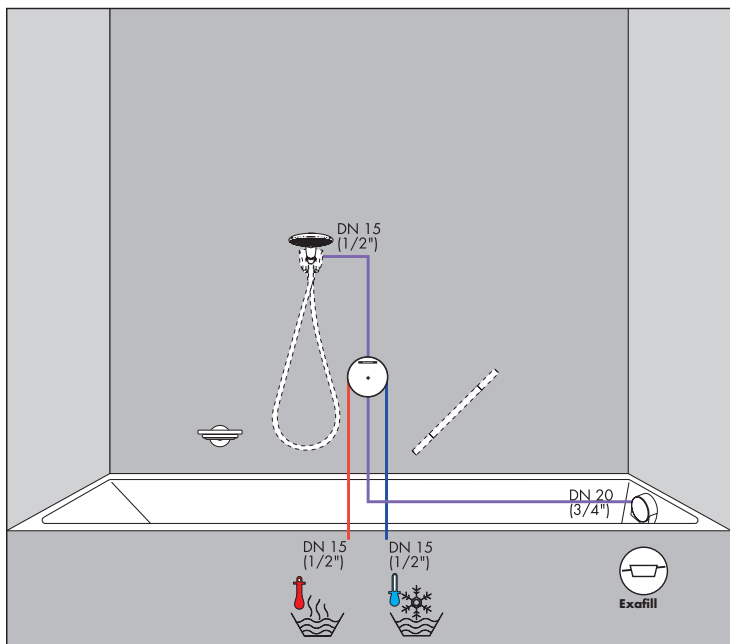

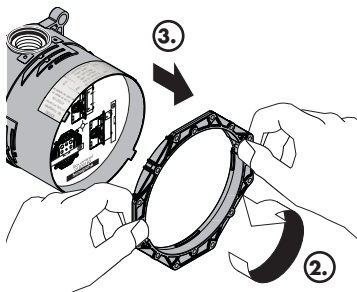
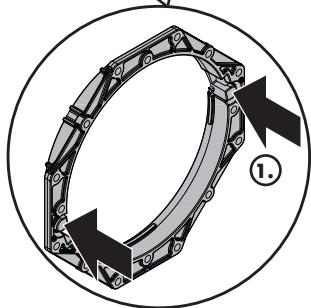
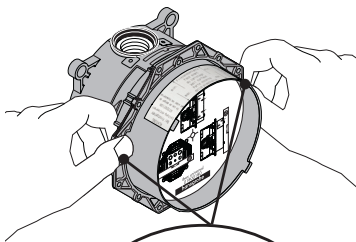
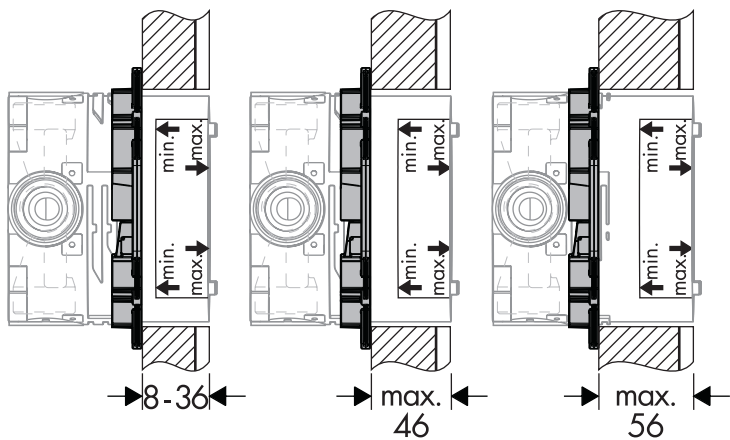

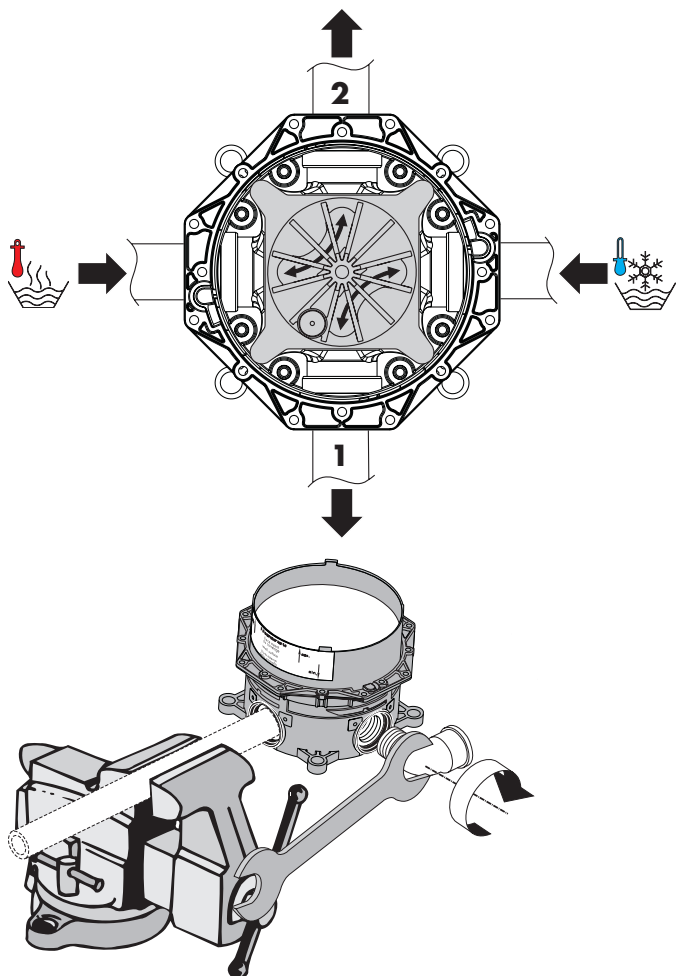

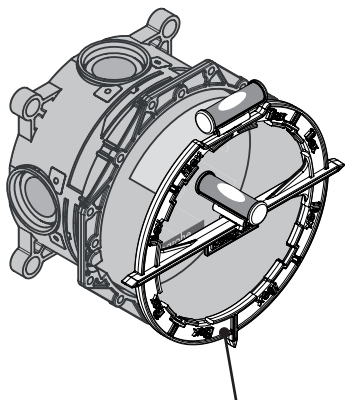
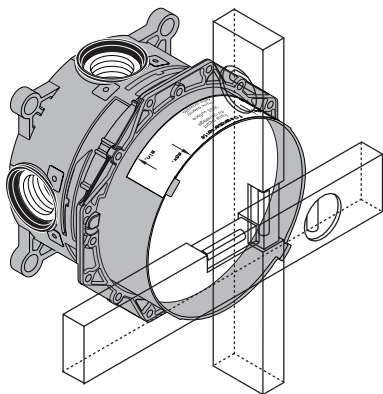

#93500000

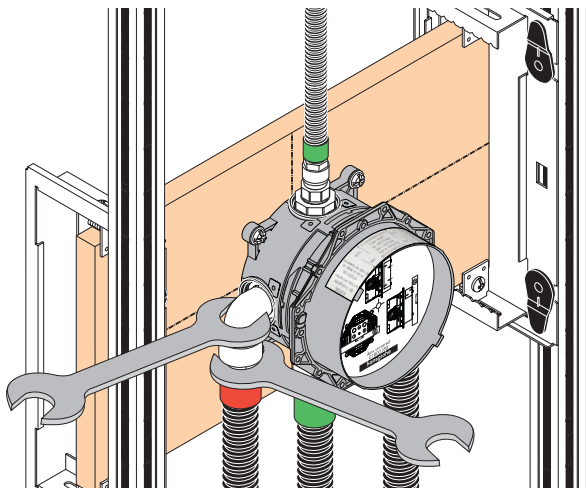

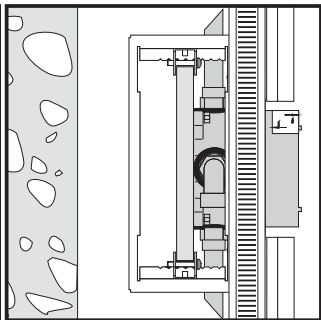
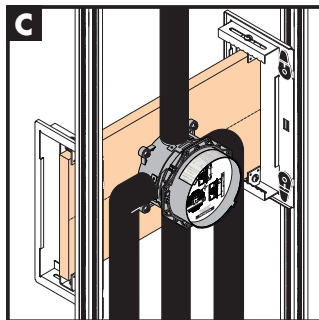
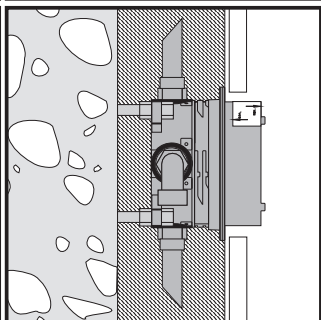
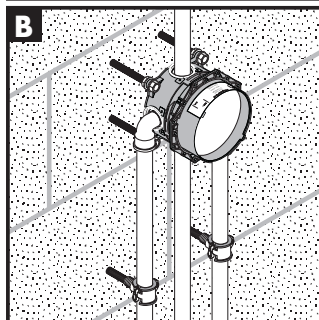
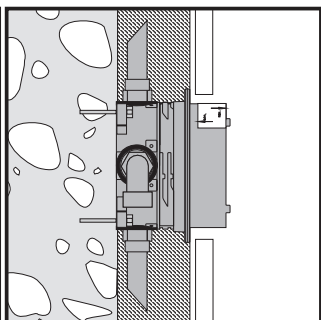
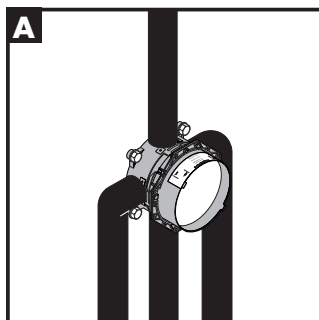

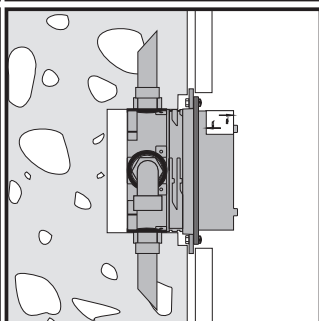
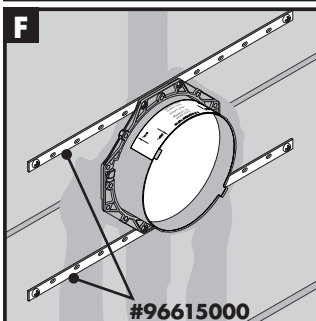
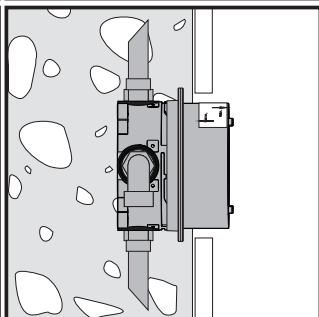
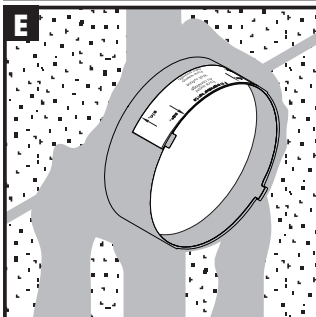
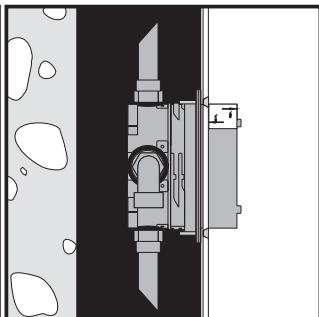
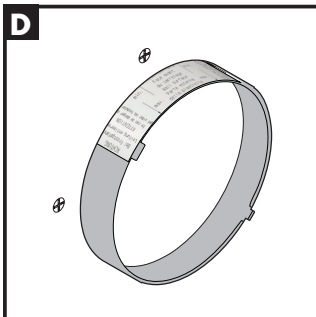

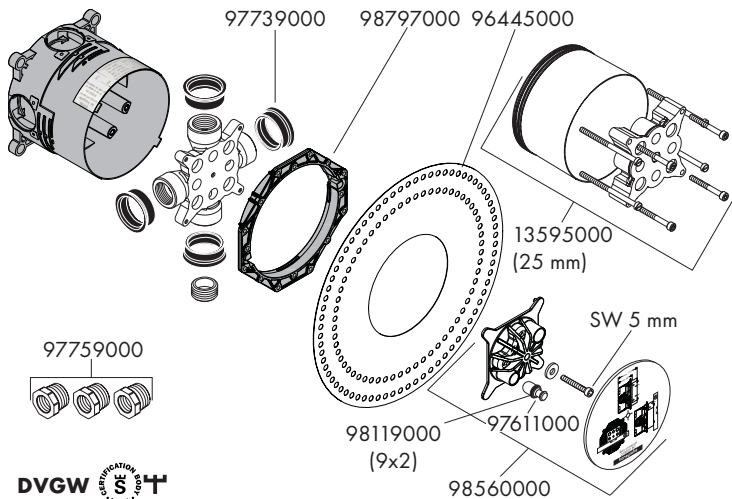
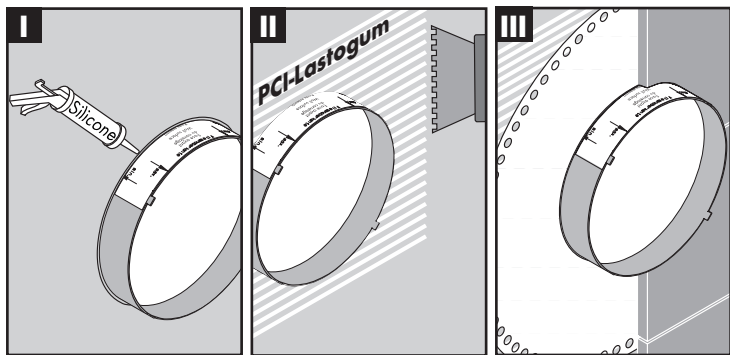

iBox universal + Exafill

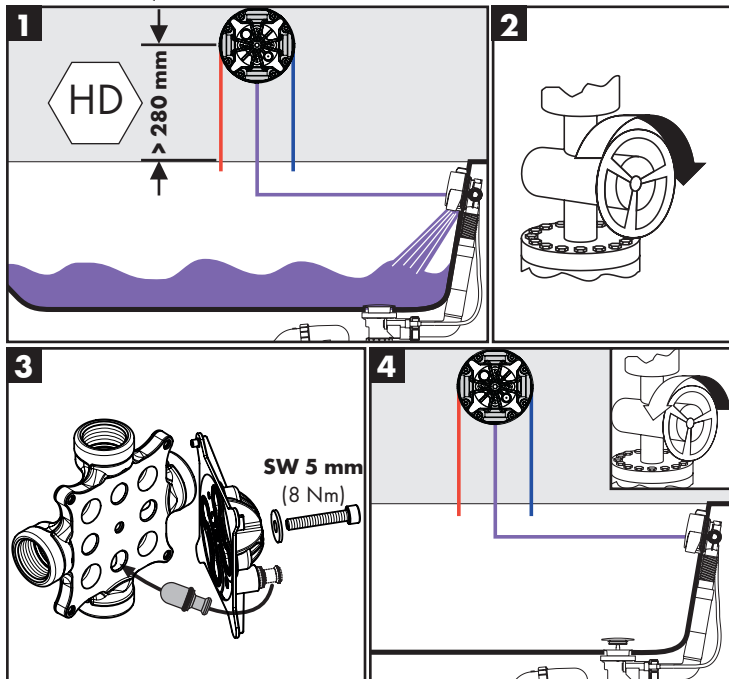
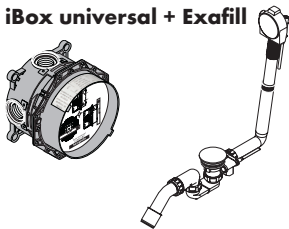

hansgrohe

Hansgrohe · Austraße 5 · 9 · D-77761 Schiltach
Telefon +49 (0) 78 36/51-1282 · Telefax +49 (0) 7836/511440
E-Mail: info@hansgrohe.com · Internet: www.hansgrohe.com

02/2024
9.0841704 R04

DE	Installationsbeispiel	2
FR	Exemple d'installation	4
EN	Installation example	6
IT	Esempio per l'installazione	8
ES	Ejemplo de instalación	10
NL	Installatievoorbeeld	12
DK	Installationseksempel	14
PT	Exemplo de instalação	16
PL	Przykład instalacji	18
CS	Příklad instalace	20
SK	Příklad inštalácie	22
ZH	安装实例	24
RU	Пример установки	26
FI	Asennusesimerkki	28
SV	Installationsexempel	30
LT	Įrengimo pavyzdžiai	32
HR	Primjer instalacije	34
TR	Kurulum örneği	36
RO	Exemplu de instalare	38
EL	Παράδειγμα εγκατάστασης	40
SL	Primer inštalacije	42
ET	Raigaldusnäide	44
LV	Uzstādīšanas piemērs	46
SR	Primer instalacije	48
NO	Installasjonseksempel	50
BG	Пример за инсталация	52
SQ	Shembull instalimi	54
AR	مثال للتثبيت	56
HU	Felszerelési példa	58

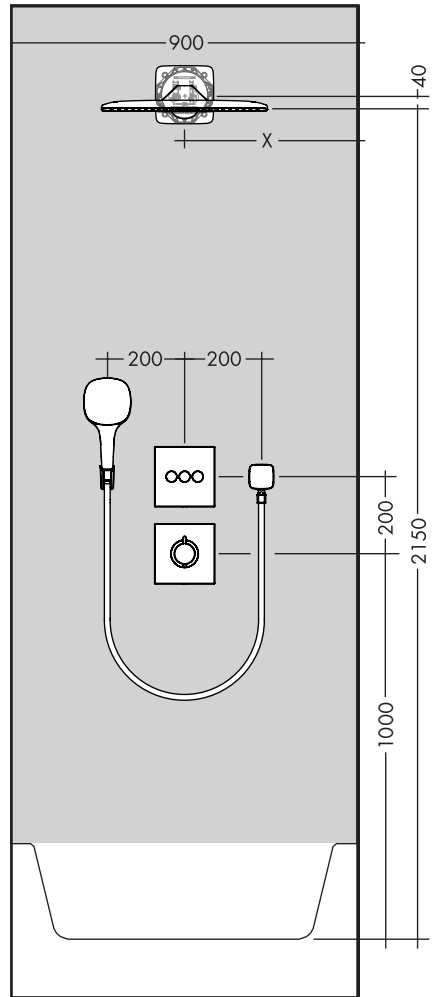



- Installationsbeispiele mit Maßangaben und Leitungsdimensionierung sind ab Seite 60 zu finden.
- Die in der Montageanleitung angegebenen Montagemaße sind ideal für Personen von ca. 1800 mm Körpergröße und müssen gegebenenfalls angepasst werden. Hierbei ist darauf zu achten, dass sich bei geänderter Montagehöhe die Mindesthöhe ändert und die Änderung der Anschlussmaße berücksichtigt werden müssen.
- Die Verbrauchswerte wurden praxisnah mit den dazugehörigen Armaturen (Thermostat/Mischer/Unterputzventil) gemessen.
- iBox in Kombination mit einer Exafill Wanneneinlauf mit Ab- und Überlaufgarnitur (siehe Seite 60)



iBox in Kombination mit einer Exafill Wanneneinlauf mit Ab- und Überlaufgarnitur

Symbolerklärung

X

Mitte Badewanne / Mitte Duschwanne

Y

Maß Y = Mitte Schlauchanschlussbogen bis Mitte Wanneneinlauf dividiert durch 2 (eventuell dem Fliesenraster anpassen).



Warmwasser



Kaltwasser



Ab • ist die Funktion gewährleistet.



In diesem Bereich ist eine Wandverstärkung notwendig.



Nur ein Verbraucher möglich, nicht zwei gleichzeitig.



Wasserleitungen für Seitenbrausen mit Gefälle verlegen.



Spülblock kpl. #15956000



Unterputz-Ventil



Quattro Vierwegeumstellung



Trio Universal Absperr- und Umstellventil



Wanneneinlauf



Der nicht benötigte Abgang muss mit einem Blindstopfen abgedichtet werden. (DN20, 3/4")



Die Ablaufleistung muss mehr als 50 l/min betragen.



Ablauf

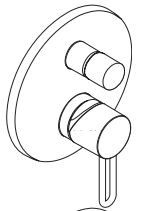

62, 72,
74

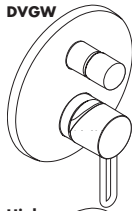

DVGW

60

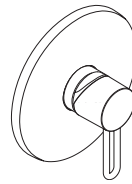

64 - 68,
82

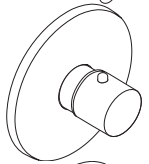

76, 80,
84

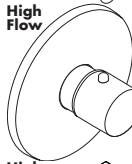

High Flow

86 - 90,
94, 96,
102 - 112

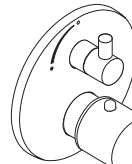

64 - 68,
82

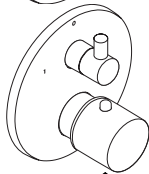

62, 72,
74, 78

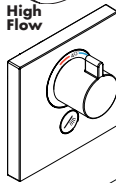

High Flow

92, 98,
100, 114

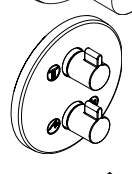

102

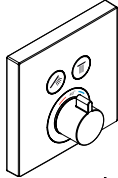

62, 72,
74, 78

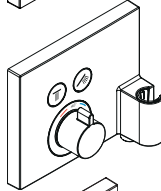

70

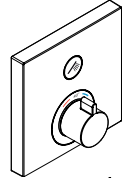

64 - 68

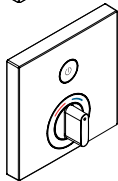

64 - 68

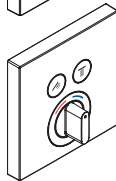

62, 72,
74, 78

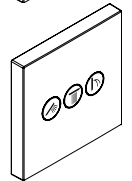

92,
98 - 102,
110 - 114

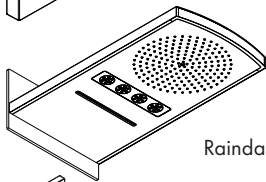

92, 94

Raindance Rainfall 240

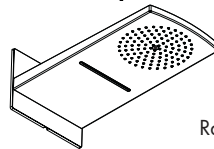

106 - 110

Raindance Rainfall 180

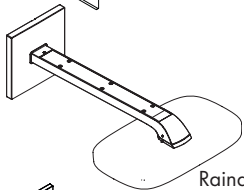

100

Raindance Select E 300

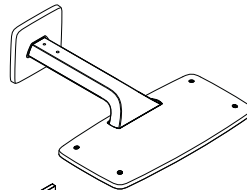

102, 104

Raindance E 420

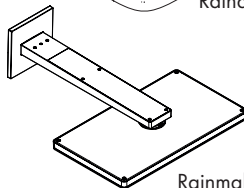

112

Rainmaker Select 460 2jet

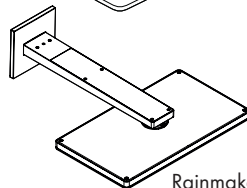

114

Rainmaker Select 460 3jet



- Des exemples d'installation avec indication de cotes et dimensions des conduites sont fournis à partir de la page 60.
- Les dimensions d'installation indiquées dans la notice de montage sont idéales pour des personnes d'une taille de 1800 mm environ et doivent être ajustées selon le cas. Tenir compte pour cela du fait qu'un changement de hauteur modifie la hauteur minimum et que la modification des cotes de raccord doit entrer en ligne de compte.
- Les valeurs de consommation ont été mesurées dans la pratique, avec les robinetteries correspondantes (thermostat/mélangeur/vanne sous crépi)
- iBox en combinaison avec un remplissage exafill avec mécanisme de vidage et de trop plein (voir pages 60)



Vidage

iBox en combinaison avec un remplissage exafill avec mécanisme de vidage et de trop plein

Description du symbole

X Centre de la baignoire / Centre cuvette de douche

Y Dimension Y = du centre raccord coudé de douche au centre bec déverseur divisé par 2 (éventuellement s'adapter au carrelage).



Eau chaude



Eau froide



A partir de • le fonctionnement est garanti.



Le mur n'a pas besoin d'être renforcé à cet endroit



Une seule utilisation possible, pas les deux ensemble.



% La tuyauterie des douchettes latérales à installer avec une pente.



bloc d'essai #15956000



Robinet d'arrêt encastré



Quattro inverseur quatre voies



Trio Robinet d'arrêt avec inverseur



Bec déverseur



La sortie non utilisée doit être condamnée avec un bouchon laiton. (DN20, 3/4")



Le débit de vidage doit être supérieur à 50 l/min.

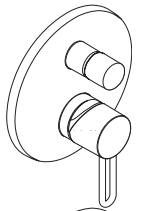

62, 72,
74

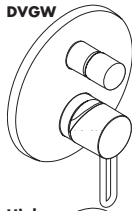

DVGW

60

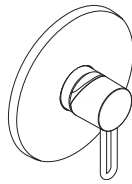

64 - 68,
82

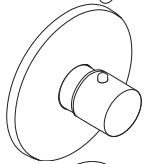

76, 80,
84

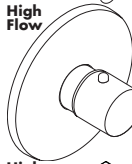

High
Flow

86 - 90,
94, 96,
102 - 112

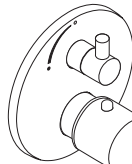

64 - 68,
82

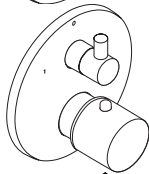

62, 72,
74, 78

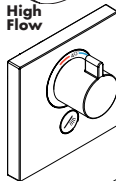

High
Flow

92, 98,
100, 114

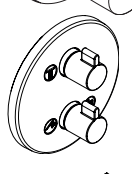

102

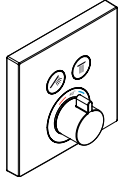

62, 72,
74, 78

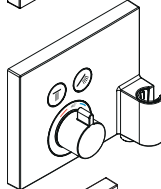

70

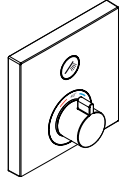

64 - 68

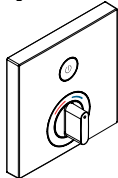

64 - 68

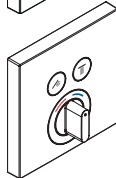

62, 72,
74, 78

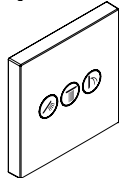

92,
98 - 102,
110 - 114

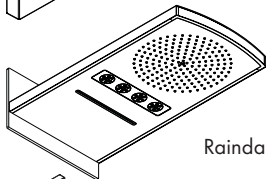

92, 94

Raindance Rainfall 240

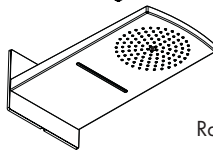

106 - 110

Raindance Rainfall 180

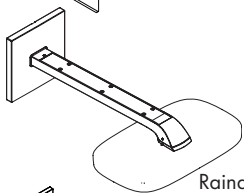

100

Raindance Select E 300

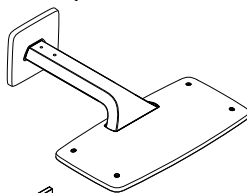

102, 104

Raindance E 420

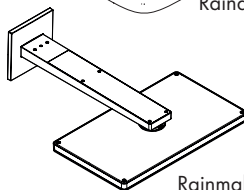

112

Rainmaker Select 460 2jet

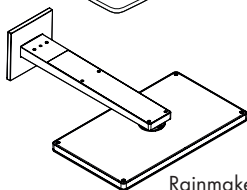

114

Rainmaker Select 460 3jet



- Installation examples with measurements and pipe dimensions can be found starting on page 60.
- The installation dimensions stated in these installation instructions are ideal for people of approximately 1800 mm in body height. The dimensions can be altered if required. In this case, pay attention to the fact that a change of installation height will also change the minimum height, and that the altered mounting dimensions must be taken into consideration.
- The consumption was measured in combination with the appropriate fittings (thermostat/mixer/in-wall valve) to reflect actual application in practice.
- iBox in combination with an Exafill bath filler with overflow and waste (see page 60)

Symbol description



Center bath tub / Center shower tub



Dimension Y = center of hose wall outlet elbow to centre of bath filler divided by 2 (match to tile layout if applicable).



Warm water



Cold water



From • the function is guaranteed.



The wall must be reinforced in this area.



Only one function is possible.



% Install water pipes for body showers with a gradient.



flushing unit complete #15956000



Shut off valve



Quattro 4-Way Diverter Valve



Trio 2-Way Diverter Valve with integrated Shut-off valve



Bath Spout



Plug the unused outlet. (DN20, 3/4")



The waste drain performance must be more than 50 l/min.



Waste



iBox in combination with an Exafill bath filler with overflow and waste

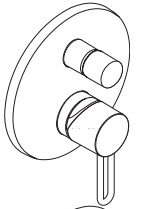

62, 72,
74

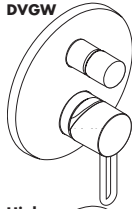

DVGW

60

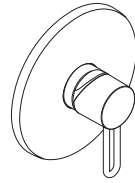

64 - 68,
82

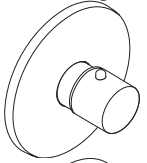

76, 80,
84

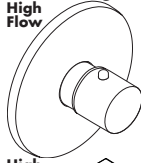

High
Flow

86 - 90,
94, 96,
102 - 112

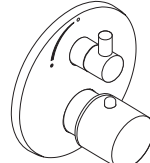

64 - 68,
82

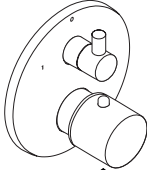

62, 72,
74, 78

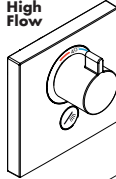

High
Flow

92, 98,
100, 114

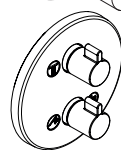

102

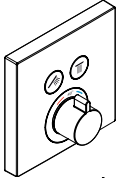

62, 72,
74, 78

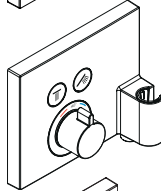

70

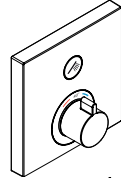

64 - 68

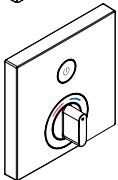

64 - 68

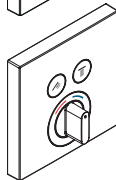

62, 72,
74, 78

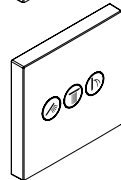

92,
98 - 102,
110 - 114

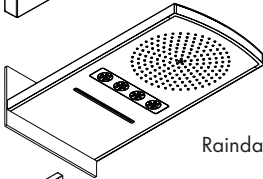

92, 94

Raindance Rainfall 240

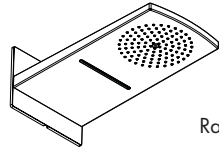

106 - 110

Raindance Rainfall 180

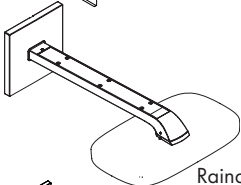

100

Raindance Select E 300

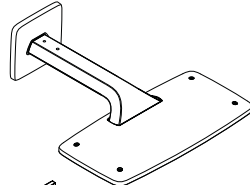

102, 104

Raindance E 420

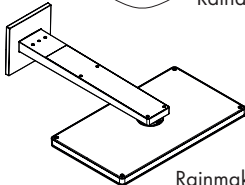

112

Rainmaker Select 460 2jet

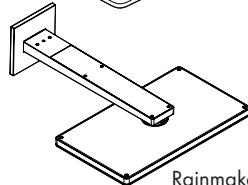

114

Rainmaker Select 460 3jet



iBox in combinazione con Exafill scarico con erogazione al troppo pieno

- Esempi per l'installazione con indicazioni delle misure e per le dimensioni delle tubature sono riportati a partire della pagina 60.
- Le quote di montaggio indicate nelle istruzioni di montaggio sono ideali per persone grandi circa 1800 mm e eventualmente vanno adattate. A ciò bisogna fare attenzione, che ad altezza di montaggio cambiata l'altezza minima necessaria indicata cambia e che bisogna considerare la modifica delle quote di collegamento.
- I valori di consumo sono stati misurati nella pratica con le armature appartenenti (Termostato/Miscelatore/Valvola sotto-intonaco).
- iBox in combinazione con Exafill scarico con erogazione al troppo pieno (vedi pagg. 60)

Descrizione simbolo

X

Centro vasca / Centro piatto doccia

Y

Valore Y = Dal centro del raccordo a muro al centro della bocca di erogazione vasca diviso 2 (eventualmente adattare alla dimensione delle piastrelle).



Acqua calda



Acqua fredda



Dal • si garantisce la funzionalità.



In questa zona è necessario un rinforzo della parete.



Non è possibile utilizzare due utenze in contemporanea.



% Posizionare i tubi alle doccette laterali con una leggera pendenza.



placca frontale # 15956000



Rubinetto di arresto



Quattro Valvola a quattro vie



Trio arresto/deviatore



Bocca di erogazione



Chiudere con un tappo l'uscita non utilizzata. (DN20, 3/4")



La portata di scarico deve essere superiore a 50 l/min.



Scarico

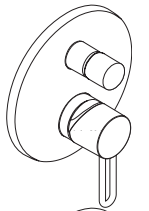

62, 72,
74

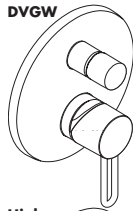

DVGW

60

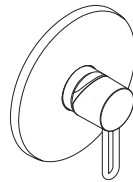

64 - 68,
82

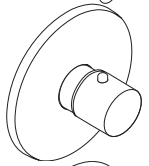

76, 80,
84

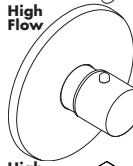

High Flow

86 - 90,
94, 96,
102 - 112

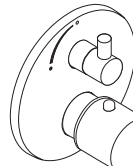

64 - 68,
82

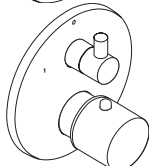

62, 72,
74, 78

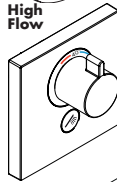

High Flow

92, 98,
100, 114

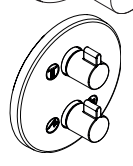

102

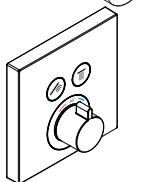

62, 72,
74, 78

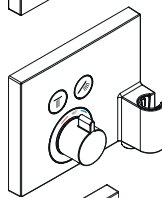

70

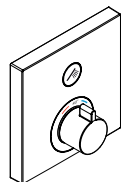

64 - 68

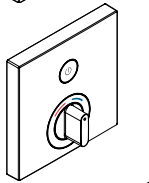

64 - 68

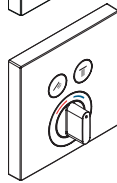

62, 72,
74, 78

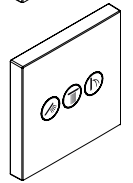

92,
98 - 102,
110 - 114

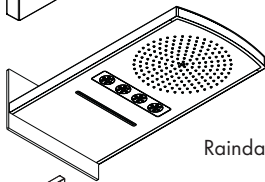

92, 94

Raindance Rainfall 240

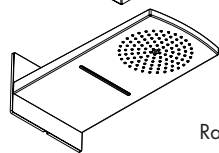

106 - 110

Raindance Rainfall 180

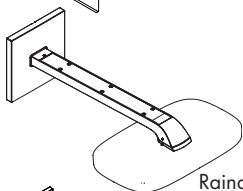

100

Raindance Select E 300

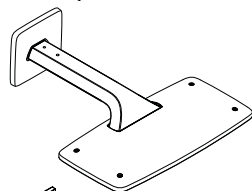

102, 104

Raindance E 420

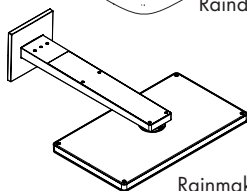

112

Rainmaker Select 460 2jet

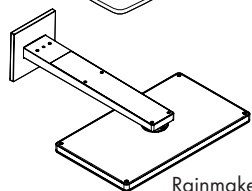

114

Rainmaker Select 460 3jet



- A partir de la página 60 puede consultar ejemplos de instalación y dimensionamiento de la conducción.
- Las medidas indicadas en las instrucciones de montaje resultan ideales para personas de 1800 mm de altura, por lo que deberán ajustarse siempre que sea necesario. En este sentido, es importante tener en cuenta que, en caso de modificación de la altura de montaje, cambia la altura mínima y habrá que adaptar las medidas de conexión.
- Los valores de consumo han sido medidos en la práctica con los grifos correspondientes (termostato/mezclador/válvula empotrada).
- iBox universal en combinación con Exafill, vaciador automático con chorro incorporado y rebosadero (ver página 60)



Desagüe

iBox universal en combinación con Exafill, vaciador automático con chorro incorporado y rebosadero

Descripción de símbolos

X Centro de la bañera / Centro la plato de ducha

Y Medida Y = Desde el centro del racor de empalme hasta el centro de la boca de entrada a la bañera dividido por 2 (si fuera necesario, adaptar a la trama de los azulejos).

 Agua caliente

 Agua fría

 Mínimo • para el correcto funcionamiento.

 En este sector es necesario un refuerzo del muro.

 Sólo una función posible, no dos funciones al mismo tiempo.

 % Tubería hacia las duchas laterales con pendiente.

 Carcasa para purgar #15956000

 Llave de paso

 Quattro válvula de 4 vías

 Trio llave de paso y distribuidor

 Caño de bañera

 La salida que no se utiliza debe ser tapada. (DN20, 3/4")

 El caudal de desagüe debe ser como mínimo de 50 l/min

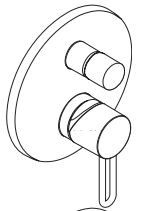

62, 72,
74

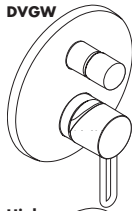

DVGW

60

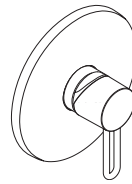

64 - 68,
82

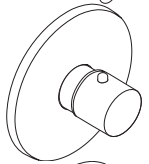

76, 80,
84

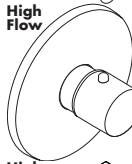

High Flow

86 - 90,
94, 96,
102 - 112

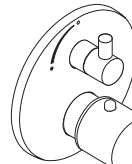

64 - 68,
82

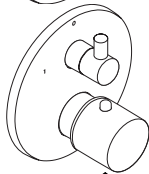

62, 72,
74, 78

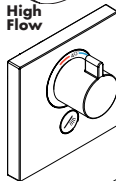

High Flow

92, 98,
100, 114

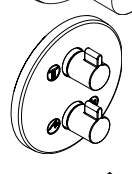

102

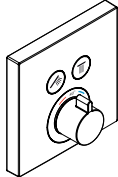

62, 72,
74, 78

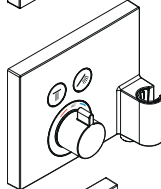

70

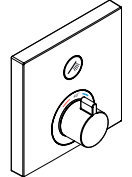

64 - 68

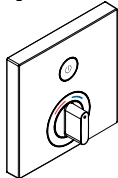

64 - 68

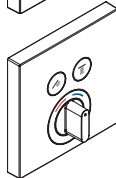

62, 72,
74, 78

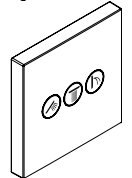

92,
98 - 102,
110 - 114

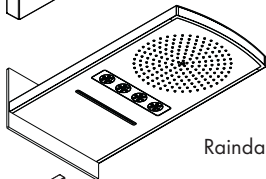

92, 94

Raindance Rainfall 240

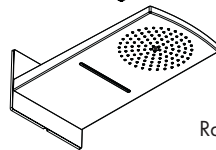

106 - 110

Raindance Rainfall 180

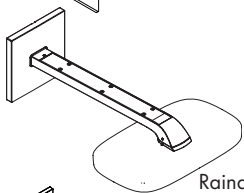

100

Raindance Select E 300

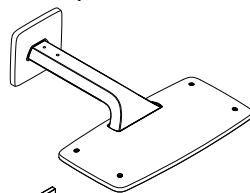

102, 104

Raindance E 420

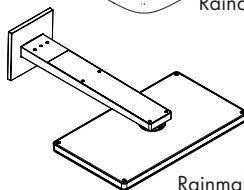

112

Rainmaker Select 460 2jet

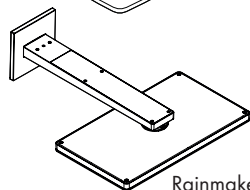

114

Rainmaker Select 460 3jet



- Installatievoorbeelden met massagegevens en capaciteitsdimensionering staan op pagina 60.
- De in de handleiding aangegeven montagematen richten zich op personen van ca. 1800 mm groot en moeten indien nodig aangepast worden. Daarbij moet in acht genomen worden dat bij een gewijzigde montagehoogte ook de minimumhoogte verandert en dat de aansluitmaten overeenkomstig moeten worden aangepast.
- De verbruikswaarden werden in overeenstemming met de praktijk met de bijbehorende armaturen (thermostaat/mengkraan/inbouwventiel) gemeten.
- iBox in combinatie met Exafill badvul-, afvoer- en overloopgarnituur (zie blz. 60)



iBox in combinatie met Exafill badvul-, afvoer- en overloopgarnituur

Symboolbeschrijving

X

Midden bad / Midden Douchebak

Y

Maat Y = afstand tussen muuraansluitbocht en baduitloop hart op hart, gedeeld door 2 (eventueel rekening houden met de wandtegels).



Warm water



Koud water



Vanaf • is het functioneren gegarandeerd.



In dit bereik is een wandversterking noodzakelijk.



Slechts 1 functie mogelijk: geen 2 functies tegelijkertijd.



% Waterleidingen voor zijdouches aflopend plaatsen.



spoelblok kompl. #15956000



Inbouwstopkraan



Quattro 4-weg omstelkraan



Trio stop- en omstelkraan



Baduitloop



De niet benodigde uitgang moet met een blindstop worden afgedicht. (DN20, 3/4")



De afvoercapaciteit moet meer dan 50 l/min bedragen.



Afvoer

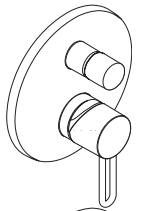

62, 72,
74

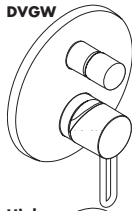

DVGW

60

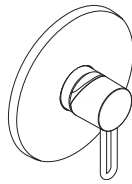

64 - 68,
82

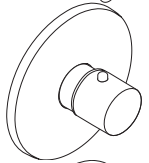

76, 80,
84

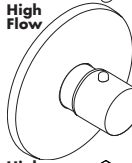

High
Flow

86 - 90,
94, 96,
102 - 112

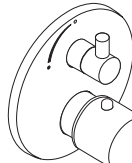

64 - 68,
82

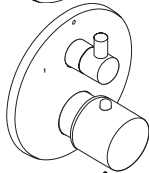

62, 72,
74, 78

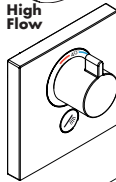

High
Flow

92, 98,
100, 114

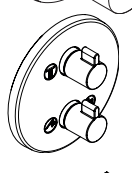

102

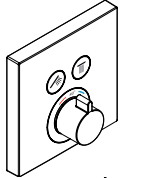

62, 72,
74, 78

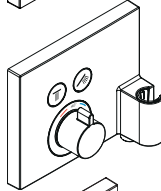

70

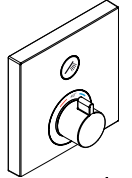

64 - 68

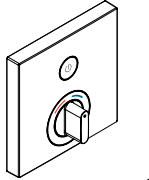

64 - 68

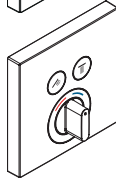

62, 72,
74, 78

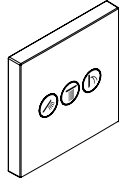

92,
98 - 102,
110 - 114

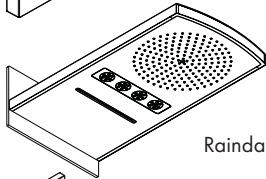

92, 94

Raindance Rainfall 240

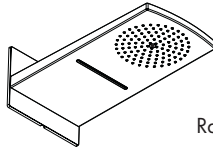

106 - 110

Raindance Rainfall 180

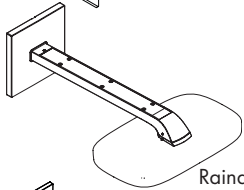

100

Raindance Select E 300

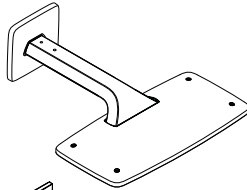

102, 104

Raindance E 420

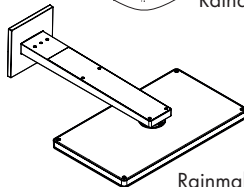

112

Rainmaker Select 460 2jet

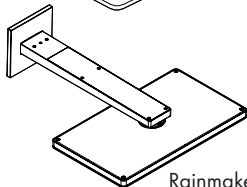

114

Rainmaker Select 460 3jet



- Installationseksempler med mål og ledningsdimensioner kan findes fra side 60.
- Målene i monteringsanvisningen er ideal til personer med en størrelse på 1800 mm og skal i givet fald tilpasses. Herved skal der tages hensyn til, at den mindste højde i tilfælde af en ændret monteringshøjde ændres og at der skal tages hensyn til de ændrede tilslutningsmål.
- Værdierne for forbruget blev målt praksisorienteret og med de tilsvarende armaturer (termostat/blender/indbygget ventil).
- iBox i kombination med Exafill påfyldnings- og overløbsgarniture (se s. 60)

Symbolbeskrivelse

X

Midt badekar / Midt brusekar

Y

Mål Y = Midt slangeudtag til midt kartud divideret med 2 (evt. tilpas med fugerne i fliserne).



Varmt vand



Kold vand



Fra • er funktionen anvendelig.



I dette område er en forstærkning af væggen nødvendigt.



Det er kun muligt at benytte én funktion ad gangen.



% Vandledninger til sidebruserne med fald.



Skylleblok kpl. # 15956000



Afspæringsventil



Quattro 4-vejs ventil



Trio afspæringsventil og omskifter



Kartud



Afgangen, der ikke benyttes, skal afproppes. (DN20, 3/4")



> 50 l/min

Afløbskapaciteten skal være mere end 50 l/min.



Raindrain

Afløb



Exafill

iBox i kombination med Exafill påfyldnings- og overløbsgarniture

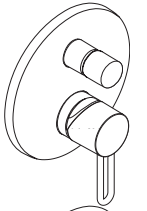

62, 72,
74

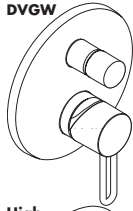

DVGW

60

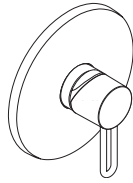

64 - 68,
82

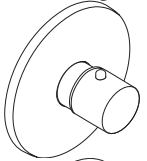

76, 80,
84

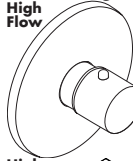

High
Flow

86 - 90,
94, 96,
102 - 112

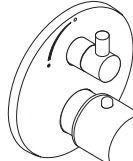

64 - 68,
82

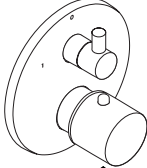

62, 72,
74, 78

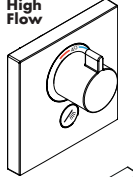

High
Flow

92, 98,
100, 114

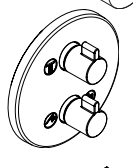

102

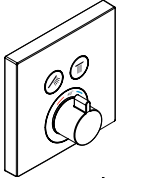

62, 72,
74, 78

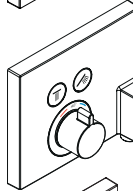

70

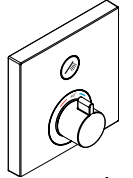

64 - 68

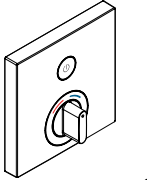

64 - 68

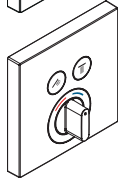

62, 72,
74, 78

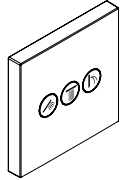

92,
98 - 102,
110 - 114

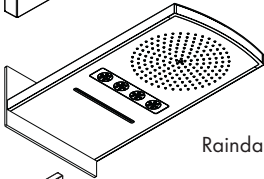

92, 94

Raindance Rainfall 240

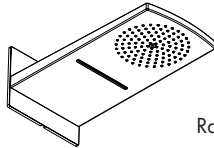

106 - 110

Raindance Rainfall 180

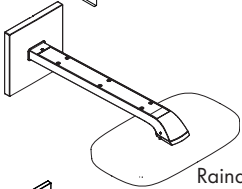

100

Raindance Select E 300

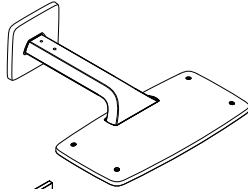

102, 104

Raindance E 420

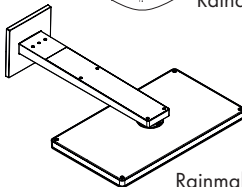

112

Rainmaker Select 460 2jet

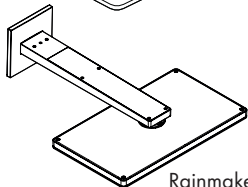

114

Rainmaker Select 460 3jet

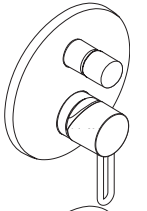

62, 72,
74

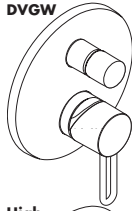

DVGW

60

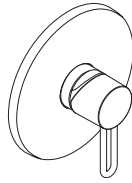

64 - 68,
82

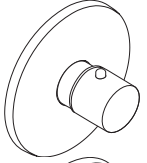

76, 80,
84

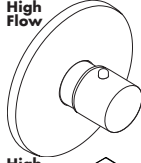

High
Flow

86 - 90,
94, 96,
102 - 112

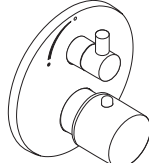

64 - 68,
82

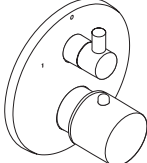

62, 72,
74, 78

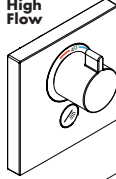

High
Flow

92, 98,
100, 114

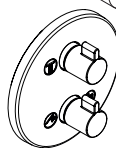

102



62, 72,
74, 78

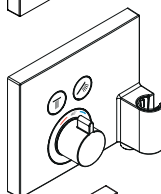

70

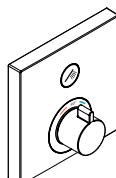

64 - 68

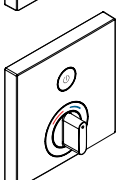

64 - 68

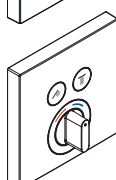

62, 72,
74, 78

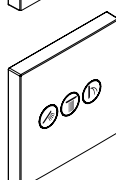

92,
98 - 102,
110 - 114

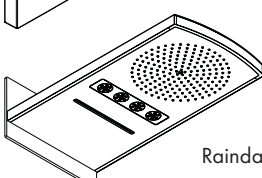

92, 94

Raindance Rainfall 240

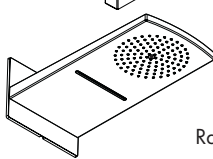

106 - 110

Raindance Rainfall 180

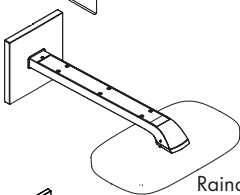

100

Raindance Select E 300

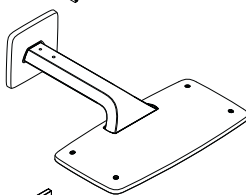

102, 104

Raindance E 420

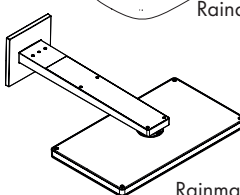

112

Rainmaker Select 460 2jet

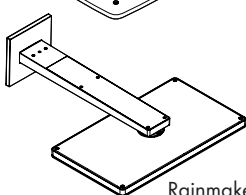

114

Rainmaker Select 460 3jet



iBox w kombinacji z odpływem wannowym Exafill posiadającym możliwość napełniania i opróżniania wanny

- Przykłady instalacji z podaniem ciężarów i rozmiarów przewodów, patrz od strony 60.
- Wymiary montażowe podane w instrukcji montażowej są idealne dla osób o wzroście sięgającym ok. 1800 mm i w razie konieczności należy je dostosować. Należy przy tym zwrócić uwagę na fakt, iż przy zmienionej wysokości montażu zmienia się minimalna wysokość, a także ulegają zmianie wymiary przyłączy.
- Wartości zużycia zostały zmierzone w praktyczny sposób za pomocą przynależnej armatury (termostat/mieszalnik/zawór podtynkowy).
- iBox w kombinacji z odpływem wannowym Exafill posiadającym możliwość napełniania i opróżniania wanny (patrz strona 60)

Opis symbolu

X

Środek wanny / Środek brodzika

Y

Wymiar Y = środek mocowania węża prysznicowego do środka wylewki napełniającej wannę podzielony przez 2 (ewentualnie dopasować do układu płytek ceramicznych).



Ciepła woda



Zimna woda



Od • możliwe jest funkcjonowanie.



W tym obszarze konieczne jest wzmocnienie ściany.



Możliwe uruchamianie tylko każdego odbiornika osobno.



Przewody doprowadzające do pryszniców bocznych położyć z nachyleniem.



Blok płuczący #15956000



Zawór podtynkowy



Regulator czterodrożny Quattro



Zawór odcinający i regulacyjny Trio Universal



Wylewka wannowa



Nie wykorzystany wylot należy zakorkować dołożonym w dostawie korkiem. (DN20, 3/4")



Wydajność odpływu musi być wyższa niż 50 l/min.



Odpływ

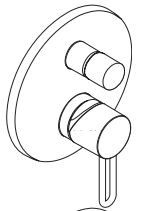

62, 72,
74

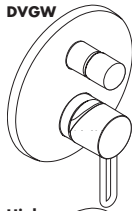

DVGW

60

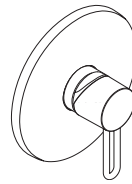

64 - 68,
82

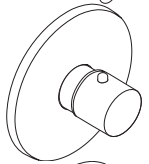

76, 80,
84

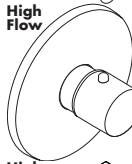

High Flow

86 - 90,
94, 96,
102 - 112

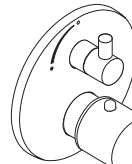

64 - 68,
82

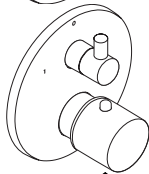

62, 72,
74, 78

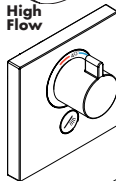

High Flow

92, 98,
100, 114

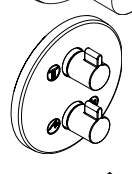

102

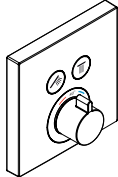

62, 72,
74, 78

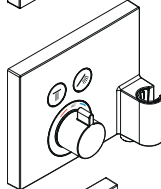

70

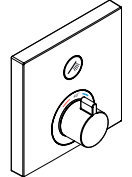

64 - 68

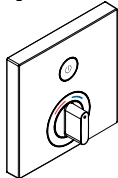

64 - 68

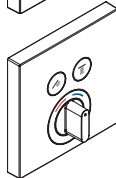

62, 72,
74, 78

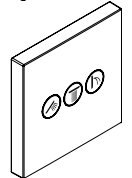

92,
98 - 102,
110 - 114

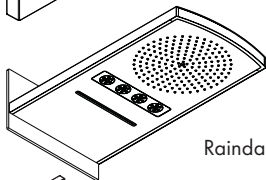

92, 94

Raindance Rainfall 240

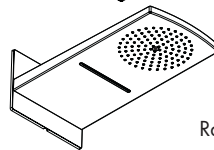

106 - 110

Raindance Rainfall 180

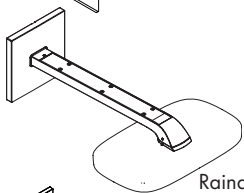

100

Raindance Select E 300

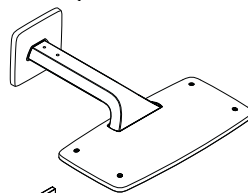

102, 104

Raindance E 420

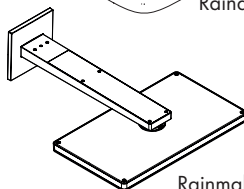

112

Rainmaker Select 460 2jet

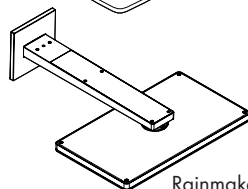

114

Rainmaker Select 460 3jet



- Příklady instalace s údaji o rozměrech a dimenzování potrubí jsou uvedeny od strany 60.
- Montážní rozměry uvedené v návodu pro montáž jsou ideální pro osoby s výškou postavy přibližně 1800 mm a v případě potřeby je nutné je přizpůsobit. Při tom je zapotřebí dbát nato, že se při změně výšce montáže změní požadovaná minimální výška a že je třeba brát ohled na připojovací rozměry.
- Spotřební hodnoty byly v praxi měřeny na příslušných armaturách (termostat/baterie/podomítkový ventil).
- iBox v kombinaci s vanovým napouštěním Exafill s odpadní a přeřadovou garniturou (viz strana 60)

Popis symbolů

X Střed koupací vany / Střed sprchové vany

Y Rozměr Y = vzdálenost středu připojení sprchové hadice od středu vanového napouštění dělitelná 2 (eventuelně přizpůsobit rozměru obkladů).



Teplá voda



Studená voda



Od • je zaručená funkce



V této oblasti je potřebné zesílení stěny.



Je možné použít pouze jeden spotřebič, ne dva současně.



% Vodovodní potrubí pro boční sprchy nainstalovat se spádem.



výplachový blok kompl. #15956000



Podomítkový uzavírací ventil



Quattro čtyřcestné přestavování



Trio Universal - Uzavírací a přepínací ventil



Vanový vtok



Nepoužitý vývod musí být utěsněn zaslepovací zátkou. (DN20, 3/4")



Odtokový výkon musí být vyšší než 50 l/min.



Odtok



iBox v kombinaci s vanovým napouštěním Exafill s odpadní a přeřadovou garniturou

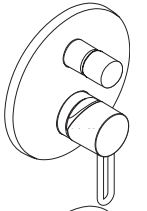

62, 72,
74

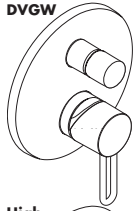

DVGW

60

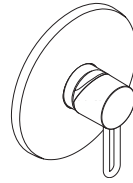

64 - 68,
82

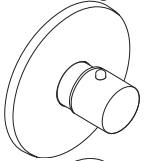

76, 80,
84

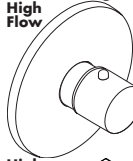

High
Flow

86 - 90,
94, 96,
102 - 112

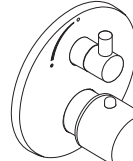

64 - 68,
82

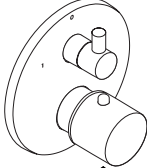

62, 72,
74, 78

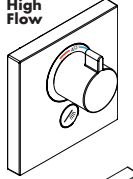

High
Flow

92, 98,
100, 114

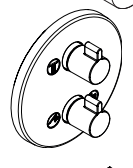

102

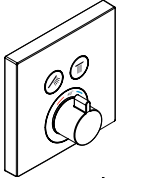

62, 72,
74, 78

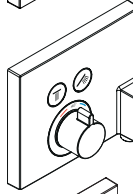

70

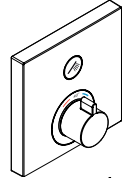

64 - 68

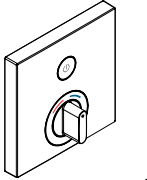

64 - 68

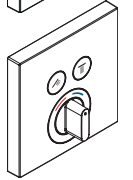

62, 72,
74, 78

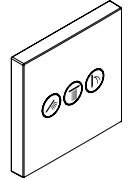

92,
98 - 102,
110 - 114

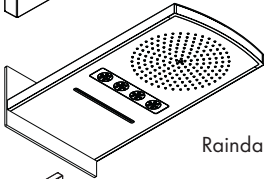

92, 94

Raindance Rainfall 240

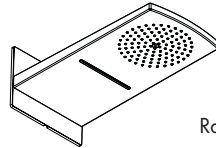

106 - 110

Raindance Rainfall 180

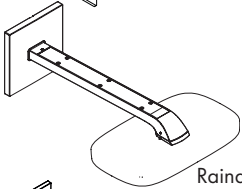

100

Raindance Select E 300

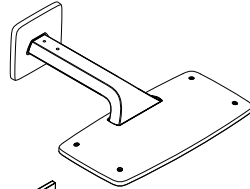

102, 104

Raindance E 420

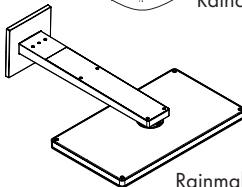

112

Rainmaker Select 460 2jet

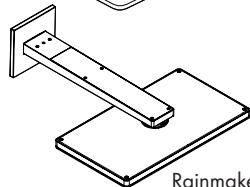

114

Rainmaker Select 460 3jet



iBox kombinovaný s EXAFILL vaňovým napúšťaním s odpadovou a prepádovou garnitúrou

- Inštaláčn  príklady s uvedením rozmerov a výkonov n jdete od strany 60.
- Mont žne rozmery uvedené v n vode na mont ž s  ide lne pre osoby s v škou postavy približne 1800 mm a v pr pade potreby je nutn e ich prisp sobit'. Pritom je nutn e si uvedomiť, že pri zmenenej v ške mont že sa mení minim lna v ška a a je nutn e dbať na rozmery rozmiestnenia pr pojok.
- Hodnoty spotreby boli meran e blízko praxe s pr sluřnými armat rami (termostat/zmieřavacia bat ria/ventil pod omietku).
- iBox kombinov ny s EXAFILL vaňov m nap šťan m s odpadovou a prepádovou garnit rou (viď strana 60)

Popis symbolov

X

Stred vane / Stred sprchovej vane

Y

Rozmer Y = vzdialenosť stredy pripojenia sprchovej hadice od stredy vaňov ho nap šťania delitel'n  2 (pr padne prisp sobit' rozmeru obkladu)



Tepl  voda



Studen  voda



Od • je zaručen  funkcia.



V tejto oblasti je potrebn e zosilnenie steny.



Je mořn e pouřivat' len jeden spotrebič, nie oba s časne.



% Vodovodn e potrubie pre bočné sprchy vyps dov ť.



Kompletn y vyps chov c  blok #15956000



Podomietkov y uzatv rac  ventil



Quattro štvorcestn e prestavenie



Trio univerz lny uzatv rac  a prestavov c  ventil



Vaňov y vtok



Nepouřit y v vod mus  byť zaslepen y z tkou. (DN20, 3/4")



V kon odtoku mus  byť v řř  ako 50 l/min.



Odtok

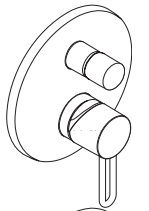

62, 72,
74

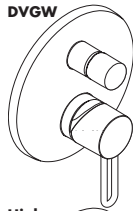

DVGW

60

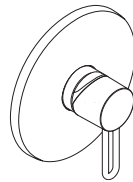

64 - 68,
82

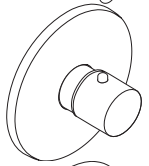

76, 80,
84

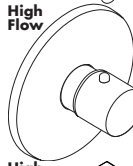

High
Flow

86 - 90,
94, 96,
102 - 112

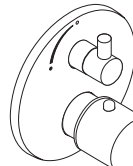

64 - 68,
82

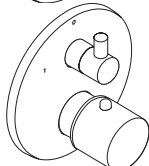

62, 72,
74, 78

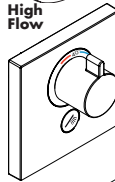

High
Flow

92, 98,
100, 114

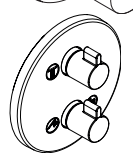

102

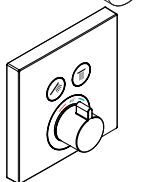

62, 72,
74, 78

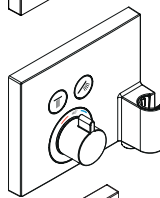

70

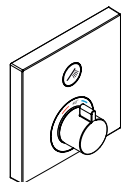

64 - 68

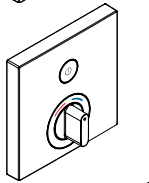

64 - 68

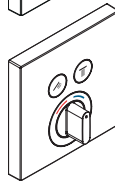

62, 72,
74, 78

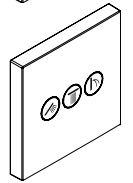

92,
98 - 102,
110 - 114

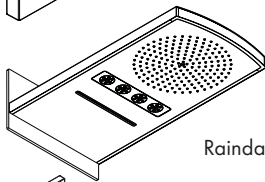

92, 94

Raindance Rainfall 240

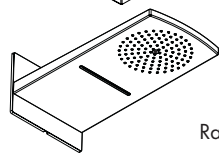

106 - 110

Raindance Rainfall 180

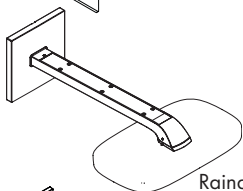

100

Raindance Select E 300

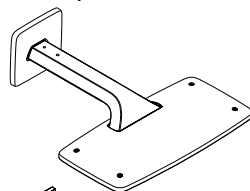

102, 104

Raindance E 420

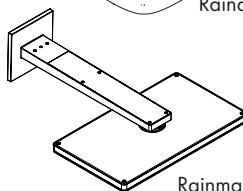

112

Rainmaker Select 460 2jet

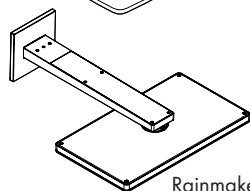

114

Rainmaker Select 460 3jet



- 带数据和管道尺寸的安装实例请从 60 页起查找。
- 本安装说明中所规定的安装尺寸理想用于身高 1800 mm 左右的人士。尺寸可根据需要进行修改。在这种情况下，您必须留意，如果安装高度改变，则花洒到地板的最小高度也随之改变，且必须考虑到连接尺寸的改变。
- 已根据实际情况测量相关龙头（恒温器/冷热水龙头/反水阀）的消耗值。
- iBox与下水部件组合，配备出水组件及溢流组件（参见第页 60）

符号说明

X

槽中间 / 中心淋浴盆

Y

尺寸Y = 软管壁出口弯管的中心至浴盆加水口中心除以2（匹配瓷砖布置）。



热水



冷水



从•开始，正常功能得以保证。



该区域需要一个加固边壁。



只有一项功能。



安装水管，用于带有梯度的淋浴器。



全套清洗端 #15956000



截止阀



Quattro 四通转换器



通用的三通截止阀和换向阀



浴缸出水口



插入不使用的插座。（DN20, 3/4"）



排水功率必须大于 50 l/min.



排水口



iBox与下水部件组合，配备出水组件及溢流组件

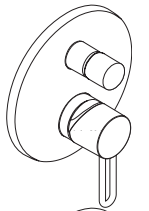

62, 72,
74

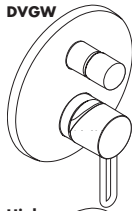

DVGW

60

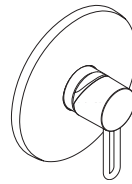

64 - 68,
82

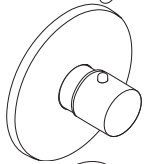

76, 80,
84

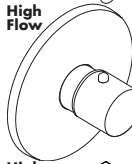

High
Flow

86 - 90,
94, 96,
102 - 112

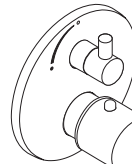

64 - 68,
82

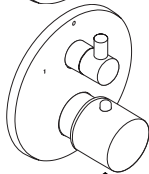

62, 72,
74, 78

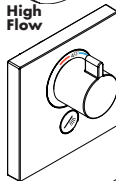

High
Flow

92, 98,
100, 114

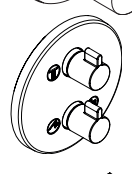

102

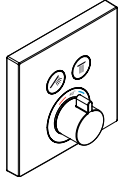

62, 72,
74, 78

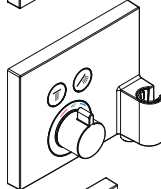

70

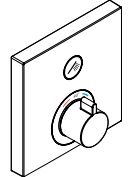

64 - 68

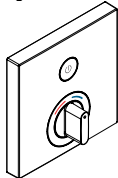

64 - 68

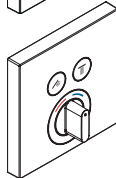

62, 72,
74, 78

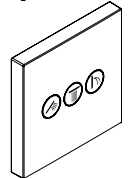

92,
98 - 102,
110 - 114

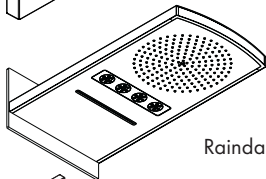

92, 94

Raindance Rainfall 240

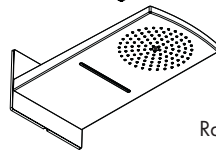

106 - 110

Raindance Rainfall 180

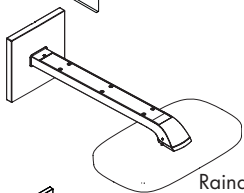

100

Raindance Select E 300

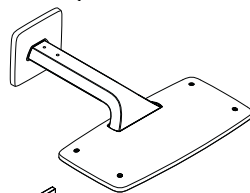

102, 104

Raindance E 420

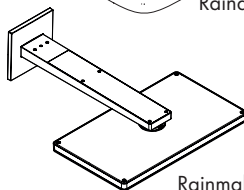

112

Rainmaker Select 460 2jet

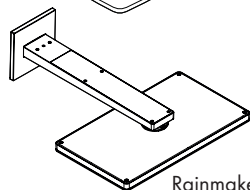

114

Rainmaker Select 460 3jet



iVox в комбинации со впуском ванны Exafill со сливной и переливной гарнитурой

- Примеры монтажа с указанием размеров и размеры трубопровода см. на стр. 60.
- Указанные в монтажной инструкции монтажные размеры идеальны для лиц ростом около 1800 мм. В случае необходимости монтажные размеры следует менять. При этом нужно учесть, что при изменившейся высоте монтажа меняется также и минимальная высота, а изменение установочных размеров нужно принять во внимание.
- Расход измерен практически с помощью соответствующей арматуры (термостат/смеситель/скрытый клапан).
- iVox в комбинации со впуском ванны Exafill со сливной и переливной гарнитурой (см. стр. 60)

Описание символов

X середина ванны / Середина душевой ванны

Y Размер Y = середина дуги подключения шланга, деленная на 2 (или подогнать по растр плитки).



Теплая вода



Холодная вода



Гарантированное функционирование при показателях свыше •.



В этой области требуется укрепление стены.



Возможно использование только одного потребителя, не двух одновременно.



% Водопроводы для боковых душей прокладывают под наклоном .



промывочный блок кпл. #15956000



Скрытый вентиль



Четырехходовой переключатель Quattro



Трехходовой запорный и переключающий вентиль Trio Universal



Водозабор



Ненужный выход необходимо уплотнить с помощью заглушки. (DN20, 3/4")



Слив должен иметь производительность более 50 л/мин.



Слив

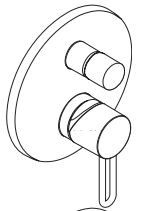

62, 72,
74

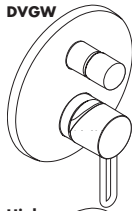

DVGW

60

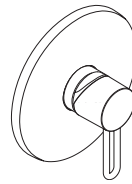

64 - 68,
82

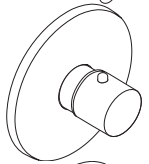

76, 80,
84

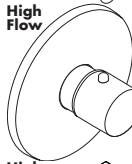

High Flow

86 - 90,
94, 96,
102 - 112

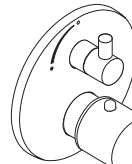

64 - 68,
82

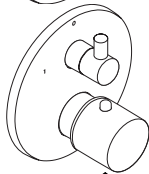

62, 72,
74, 78

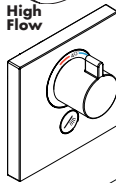

High Flow

92, 98,
100, 114

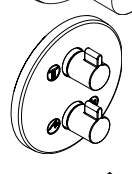

102

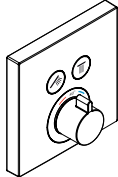

62, 72,
74, 78

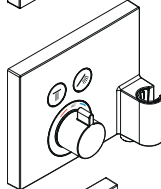

70

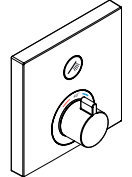

64 - 68

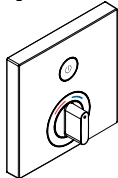

64 - 68

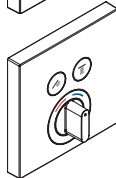

62, 72,
74, 78

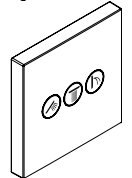

92,
98 - 102,
110 - 114

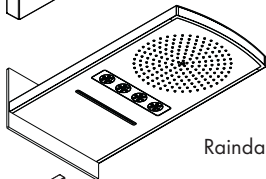

92, 94

Raindance Rainfall 240

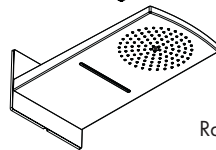

106 - 110

Raindance Rainfall 180

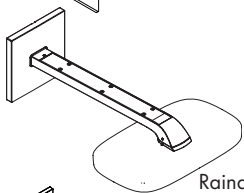

100

Raindance Select E 300

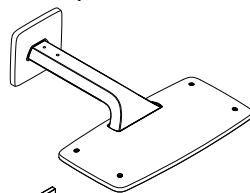

102, 104

Raindance E 420

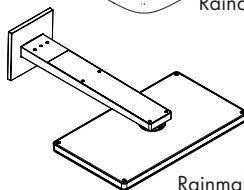

112

Rainmaker Select 460 2jet

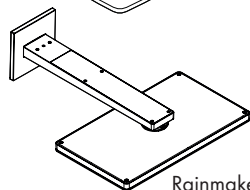

114

Rainmaker Select 460 3jet



- Asennusesimerkit mittoineen ja putkitietoineen löytyvät alkaen sivulta 60.
- Asennusohjeessa annetut asennusmitat sopivat n. 180 cm:n pituiselle henkilölle, ja niitä on tarvittaessa muutettava. Tässä on otettava huomioon, että asennuskorkeuden muuttuessa muuttuu myös vähimmäiskorkeus, ja muutos on otettava huomioon liitäntöjen mitoissa.
- Kulutusarvot on mitattu käytännönläheisesti kaikkine armatuureineen (termostaatti/sekoitin/seinäventtiili).
- iBox yhdessä Exafill ammeentäyttöhana varustettuna tyhjennys- ja ylivuotovarusteilla (katso sivu 60)

Merkin kuvaus

X

Ammeen keskusta / Suihkualtaan keskusta

Y

Mitta Y = etäisyys letkunliitäntäkaaren keskeltä ammeen tuloaukon keskelle jaettuna kahdella (sovitus mahdollisesti laattaruudukkoon).



Lämmin vesi



Kylmä vesi



Tämä toiminta on taattuna • alkaen.



Tässä kohdassa seinää on vahvistettava



Vain yksi vedenkäyttöpiste kerrallaan on mahdollista, ei kahta samanaikaisesti.



% Vie sivusuihkujen syöttöputket alaspäin laskevasti.



Huuhtelulohko, täyd. #15956000



Upotettava venttiili



4-tiesäätöventtiili



Trio -sulku- ja säätöventtiili



Vedentulo ammeeseen



Käyttömätön lähtöliitin on suljettava sulkutulpalalla. (DN20, 3/4")



Poisvirtaustehon on oltava enemmän kuin 50l/min.



Veden poisvirtaus



iBox yhdessä Exafill ammeentäyttöhana varustettuna tyhjennys- ja ylivuotovarusteilla

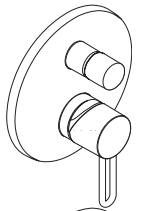

62, 72,
74

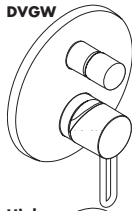

DVGW

60

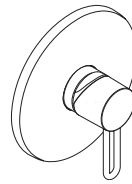

64 - 68,
82

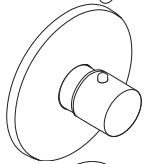

76, 80,
84

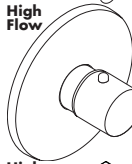

High
Flow

86 - 90,
94, 96,
102 - 112

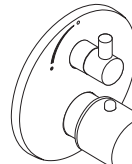

64 - 68,
82

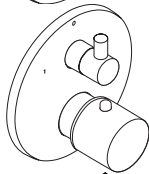

62, 72,
74, 78

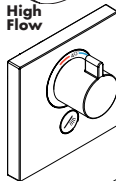

High
Flow

92, 98,
100, 114

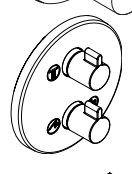

102

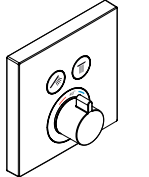

62, 72,
74, 78

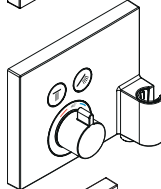

70

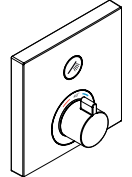

64 - 68

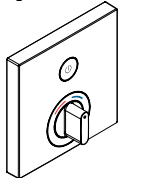

64 - 68

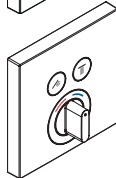

62, 72,
74, 78

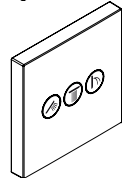

92,
98 - 102,
110 - 114

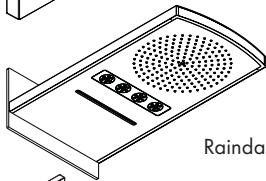

92, 94

Raindance Rainfall 240

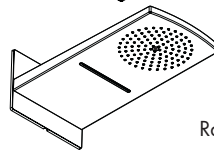

106 - 110

Raindance Rainfall 180

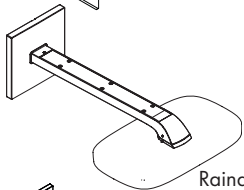

100

Raindance Select E 300

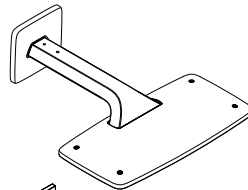

102, 104

Raindance E 420

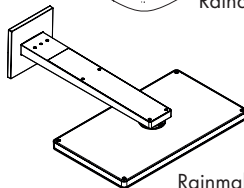

112

Rainmaker Select 460 2jet

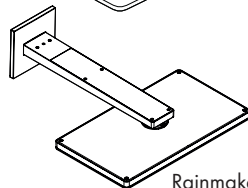

114

Rainmaker Select 460 3jet



- Du hittar installationsexempel med uppgifter om mått och ledningsdimensioner från sidan 60.
- De monteringsmått som anges i monteringsanvisningen passar 1,80 m långa personer och måste eventuellt anpassas. Det är då viktigt att tänka på att den minsta höjden ändras när monteringshöjden blir en annan och att hänsyn måste tas till de ändrade anslutningsmått.
- Förbrukningsvärdena uppmättes under användning med de tillhörande armaturerna (termostat/blandare/infälld ventil).
- iBox i kombination med ett Exafill karinlopp med från- och överrinningsset (se sidan 60)

Symbolförklaring

X

Mitt på badkar / Mitten av duschkaret

Y

Mått Y = mitten av slanganslutningskrök till mitten av karinlopp delat med två (anpassa eventuellt till kakelmönstret).



Varmvatten



Kallvatten



Från • garanteras funktionen.



Šioje zonoje būtinas sienos sutvirtinimas



Endast en enhet möjlig, inte två samtidigt.



Drag vattenledningar till sidoduschar med fall.



Spolblock kompl. #15956000



Invändig ventil



Quattro Fyrvägsomkastare



Trio Universell avstängningsventil och omkastare



Badkarskran



Det utlopp som inte behövs måste tätas med en blindstopp. (DN20, 3/4")



Avloppet måste klara mer än 50 l/min.



Avlopp



iBox i kombination med ett Exafill karinlopp med från- och överrinningsset

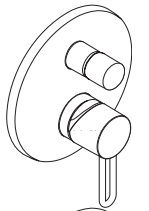

62, 72,
74

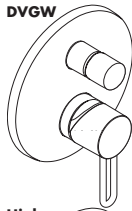

DVGW

60

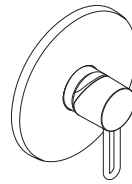

64 - 68,
82

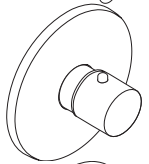

76, 80,
84

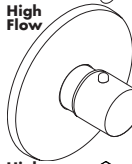

High
Flow

86 - 90,
94, 96,
102 - 112

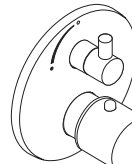

64 - 68,
82

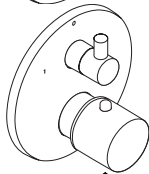

62, 72,
74, 78

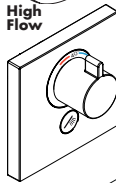

High
Flow

92, 98,
100, 114

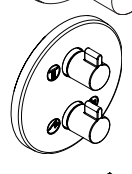

102

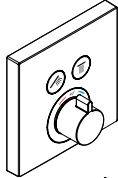

62, 72,
74, 78

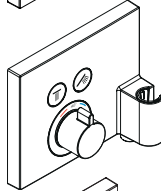

70

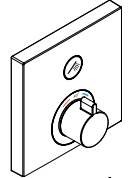

64 - 68

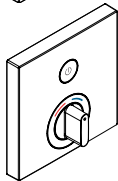

64 - 68

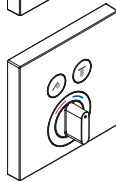

62, 72,
74, 78

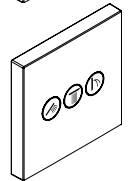

92,
98 - 102,
110 - 114

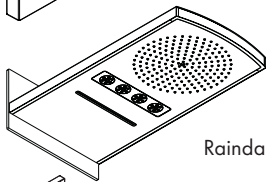

92, 94

Raindance Rainfall 240

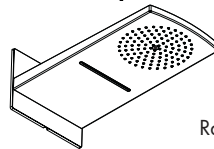

106 - 110

Raindance Rainfall 180

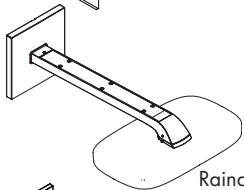

100

Raindance Select E 300

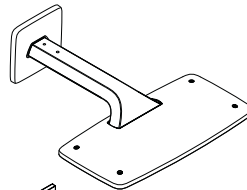

102, 104

Raindance E 420

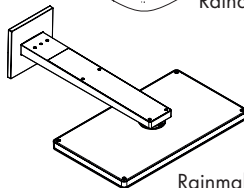

112

Rainmaker Select 460 2jet

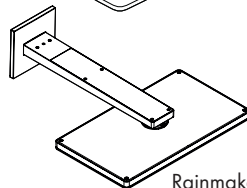

114

Rainmaker Select 460 3jet



- Įrengimo pavyzdžiai su nurodytais matmenimis ir vamzdyno dydžiais pateikti 60 puslapyje.
- Montavimo instrukcijoje nurodyti išmatavimai idealiai tinka 1800 mm ūgio žmonėms. Galima keisti aukštį, bet tuomet keičiasi minimalus rekomenduojamas patalpos aukštis ir turi būti atsižvelgta į vandens jungties matmenų pasikeitimą.
- Sąnaudų išmatuotos artimomis realioms sąlygomis su reikiamomis dalimis (termostatu / maišytuvu / potinkiniu čiaupu).
- iBox kartu su Exafill vonios čiaupu ir išleidimo bei apsauginės angos rinkiniais (žr. psl. 60)

Simbolio aprašymas

X

Vonios vidurys / Dušo padėklo centras

Y

Matmuo Y = atstumas nuo dušo žarnos jungties centro iki čiaupo centro, padalintas iš 2 (jei įmanoma, taikykite prie plytelių).



Šiltas vanduo



Šaltas vanduo



Nuo • funkcionavimas garantuotas



Šioje zonoje būtinas sienos sutvirtinimas



Vienu metu galima tik viena funkcija.



% Privesti vamzdžius šoniniams purkštukams.



Plaunamojo bloko jungtis #15956000



Potinkinis uždarymo vožtuvas



„Quattro“ 4-krypčių perjungimas



Užtvarinis ir perjungimo vožtuvas „Trio Universal“



Vonios įeiga



Nenaudojamą išėjimą užaklinti. (DN20, 3/4")



Nutekėjimo našumas turi būti ne mažesnis
50 l/min



Nutekėjimas



iBox kartu su Exafill vonios čiaupu ir išleidimo bei apsauginės angos rinkiniais

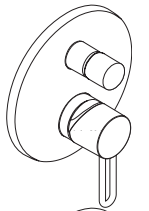

62, 72,
74

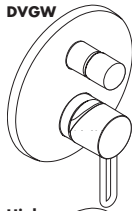

DVGW

60

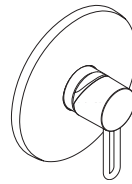

64 - 68,
82

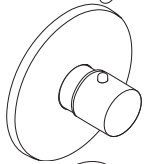

76, 80,
84

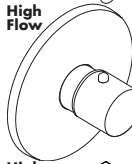

High Flow

86 - 90,
94, 96,
102 - 112

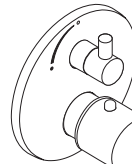

64 - 68,
82

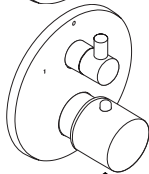

62, 72,
74, 78

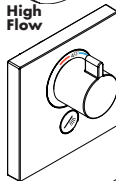

High Flow

92, 98,
100, 114

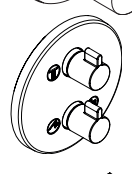

102

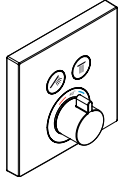

62, 72,
74, 78

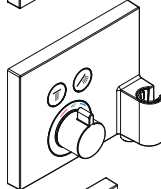

70

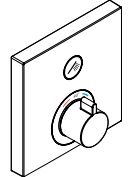

64 - 68

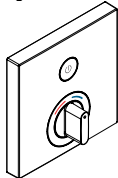

64 - 68

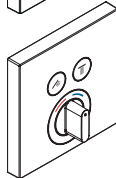

62, 72,
74, 78

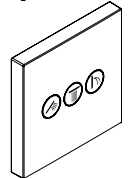

92,
98 - 102,
110 - 114

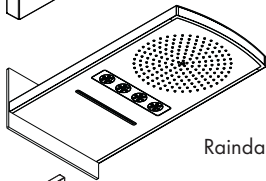

92, 94

Raindance Rainfall 240

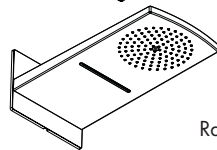

106 - 110

Raindance Rainfall 180

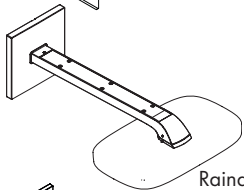

100

Raindance Select E 300

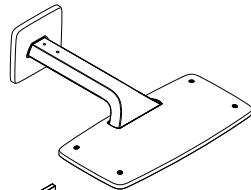

102, 104

Raindance E 420

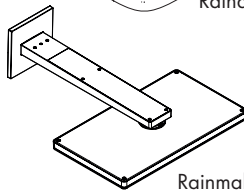

112

Rainmaker Select 460 2jet

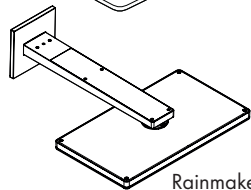

114

Rainmaker Select 460 3jet



iBox u kombinaciji s Exafill ispustom u kadu s odvodnom i preljevnom garniturom

- Primjeri instalacija s veličinama i dimenzijama vodova mogu se naći od stranice 60 nadalje.
- Montažne dimenzije navedene u uputama za montažu idealne su za osobe visine oko 1800 mm te se prema potrebi moraju prilagoditi konkretnoj visini korisnika. Pritom valja uzeti u obzir da se u slučaju promjene montažne visine mijenja i minimalna visina kao i da se tada mora uvažiti i promjena priključnih dimenzija.
- Vrijednosti potrošnje u praksi mjerene su s pripadajućim armaturama (termostat/mješač/podžbukni ventil).
- iBox u kombinaciji s Exafill ispustom u kadu s odvodnom i preljevnom garniturom (pogledaj stranicu 60)

Opis simbola

X

Sredina kade / Sredina tuš-kada

Y

Mjera Y = sredina priključka crijeva do sredine filtera kade podijeljeno sa 2 (eventualno prilagoditi rasteru pločica)



Topla voda



Hladna voda



Zajamčena funkcija od • naviše



U ovom je području potrebno ojačanje zida.



Moguće je koristiti samo jedno trošilo, nikako dva istovremeno!



Položite vodovodne cijevi za bočni tuš s nagibom



kompletni blok #15956000



Podžbukni ventil



Quattro četverostruki preusmjerivač



Trio Universal ventil za zatvaranje i ventil selektora



Ispust u kadu



Potrebno je ostaviti zatvoren izlaz koji se ne koristi (DN20, 3/4")



Protok vode mora biti veći od 50 l/min.



Odvod

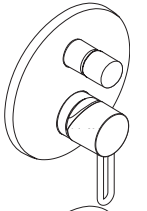

62, 72,
74

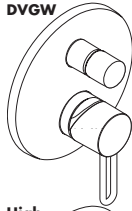

DVGW

60

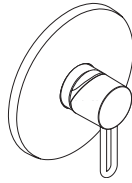

64 - 68,
82

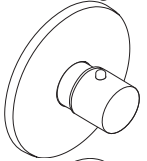

76, 80,
84

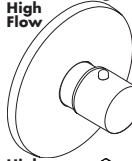

High Flow

86 - 90,
94, 96,
102 - 112

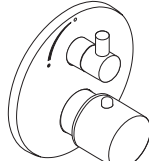

64 - 68,
82

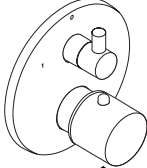

62, 72,
74, 78

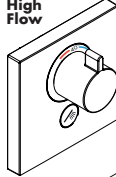

High Flow

92, 98,
100, 114

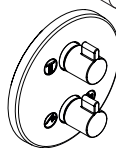

102

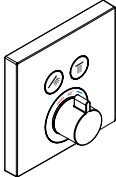

62, 72,
74, 78

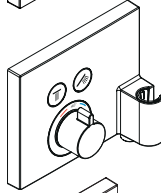

70

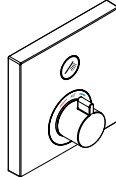

64 - 68

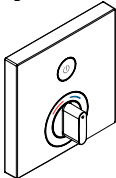

64 - 68

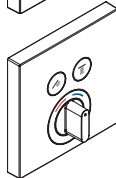

62, 72,
74, 78

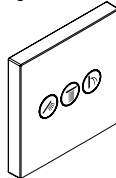

92,
98 - 102,
110 - 114

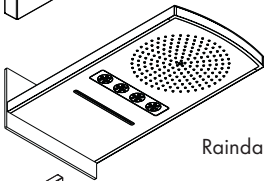

92, 94

Raindance Rainfall 240

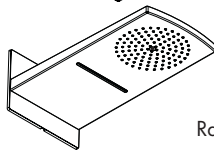

106 - 110

Raindance Rainfall 180

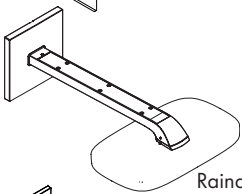

100

Raindance Select E 300

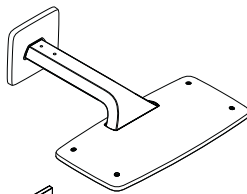

102, 104

Raindance E 420

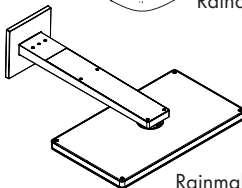

112

Rainmaker Select 460 2jet

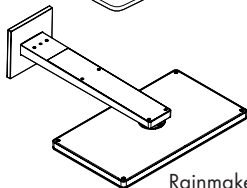

114

Rainmaker Select 460 3jet



- Ölçü verileri ve hat boyutlandırıcılı tesisat örnekleri Sayfa 60 itibariyle bulunabilir.
- Montaj kılavuzunda belirtilen montaj ölçüleri, yaklaşık 1.800 mm boyundaki kişiler için idealdir ve gerekirse adapte edilmelidir. Bu sırada, montaj yüksekliğinin değişmesiyle birlikte minimum yüksekliğin de değiştiğine ve bağlantı ölçülerindeki değişikliğin göz önüne alınması gerektiğine dikkat edilmelidir.
- Tüketim değerleri uygulamalı olarak ilgili armatürlere (termostat/karıştırıcı/sıva altı valf) ölçülmüştür.
- Çıkış ve taşma aksesuarlı bir Exafill batarya girişiyle bağlantılı iBox (bakınız sayfa 60)

Simge açıklaması

X

Küvetin ortası / Duş küvetinin ortası

Y

Y = Hortum bağlantı kavisinin ortasından küvet girişinin ortası arasındaki ölçü 2'ye bölünür (gerekirse fayans bölümlerine adapte edin).



Sıcak su



Soğuk su



•'den itibaren fonksiyon garanti edilmiştir.



Bu alanda duvarın kalınlaştırılması gereklidir.



Sadece bir tüketici mümkündür, aynı anda iki tüketici mümkün değildir.



% Yan duşların su hatlarını eğimli şekilde döşeyin.



Yıkama bloğu komple #15956000



Sıva altı valfi



Quattro dört yöllu değiştirme



Trio üniversal kapatma ve değiştirme valfi



Küvet su girişi



Kullanılmayan çıkış bir kör tapayla izole edilmelidir. (DN20, 3/4")



Akış kapasitesi 50 l/dak üzerinde olmalıdır.



Akış



Çıkış ve taşma aksesuarlı bir Exafill batarya girişiyle bağlantılı iBox

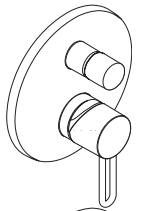

62, 72,
74

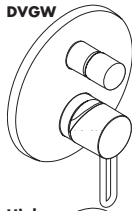

DVGW

60

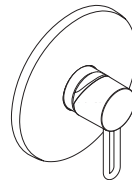

64 - 68,
82

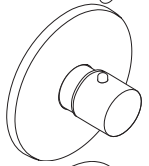

76, 80,
84

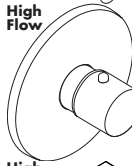

High
Flow

86 - 90,
94, 96,
102 - 112

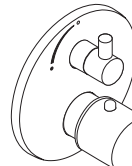

64 - 68,
82

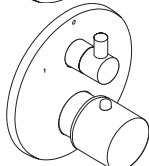

62, 72,
74, 78

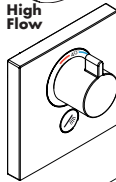

High
Flow

92, 98,
100, 114

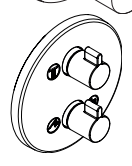

102

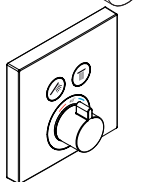

62, 72,
74, 78

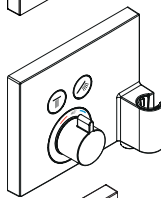

70

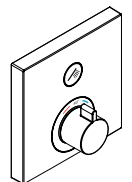

64 - 68

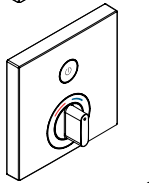

64 - 68

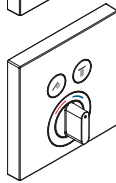

62, 72,
74, 78

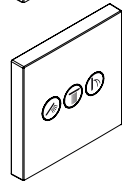

92,
98 - 102,
110 - 114

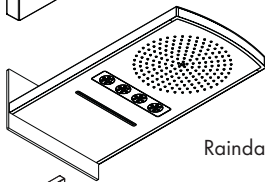

92, 94

Raindance Rainfall 240

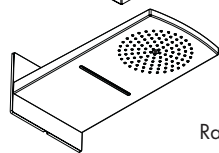

106 - 110

Raindance Rainfall 180

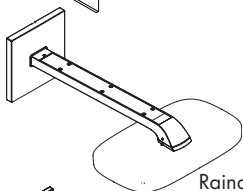

100

Raindance Select E 300

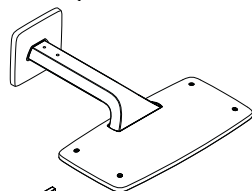

102, 104

Raindance E 420

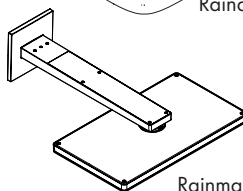

112

Rainmaker Select 460 2jet

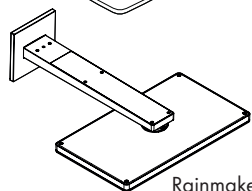

114

Rainmaker Select 460 3jet



- Exemplele de montaj cu specificații referitoare la dimensiuni și capacitate se găsesc începând de la pagina 60.
- Dimensiunile de montare din instrucțiunile de montare sunt ideale pentru persoane cu o înălțime de cca. 1800 mm și trebuie modificate dacă este cazul. Aici trebuie să ții cont de modificarea înălțimii de montare, deoarece în acest caz se va modifica și înălțimea minimă de montare și astfel trebuie modificate toate dimensiunile de racordare.
- Rile de consum au fost măsurate pe teren cu armăturile corespunzătoare (termostat, robinet de amestecare, supapă sub tencuială).
- Cutie iBox în combinație cu Exafill pe intrarea în cadă, cu un set pentru evacuare și deversare. (vezi pag. 60)



Capacitatea de evacuare trebuie să fie mai mare de 50 l/min.



Deversor

Cutie iBox în combinație cu Exafill pe intrarea în cadă, cu un set pentru evacuare și deversare.

Descrierea simbolurilor

X Cadă de baie în mijloc / În mijlocul căzii de duș

Y Dimensiune Y = distanța între mijlocul racordului pentru furtună și intrare cadă împărțită la doi (eventual potrivit la suprafața tencuielii).



Apă caldă



Apă rece



Începând de la • funcționarea este garantată.



În această zonă este nevoie de întărirea peretelui.



Se poate conecta numai un singur consumator, nu se pot conecta doi în același timp.



% Montați conductele de apă înclinate (în cădere) pentru dușurile laterale.



Complet spălare #15956000



Ventil montat sub tencuială



Quattro valvă de inversare cu patru căi



Trio valvă de închidere și de inversare universală



Gură de admisiune



Racordurile neutilizate trebuie acoperite cu dop etanș. (DN20, 3/4")

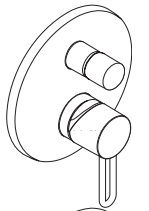

62, 72,
74

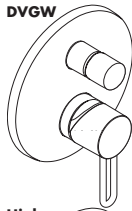

DVGW

60

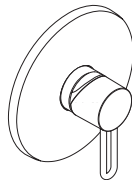

64 - 68,
82

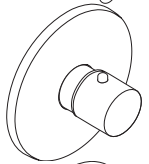

76, 80,
84

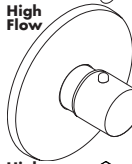

High
Flow

86 - 90,
94, 96,
102 - 112

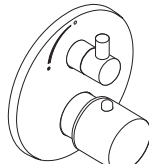

64 - 68,
82

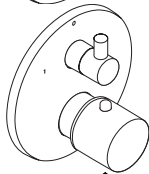

62, 72,
74, 78

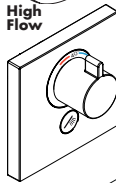

High
Flow

92, 98,
100, 114

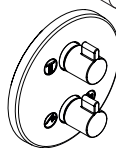

102

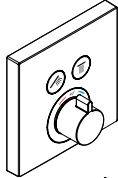

62, 72,
74, 78

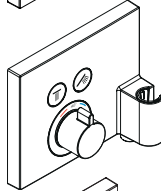

70

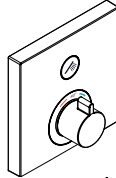

64 - 68

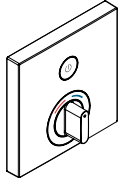

64 - 68

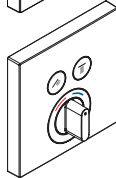

62, 72,
74, 78

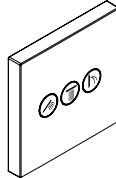

92,
98 - 102,
110 - 114

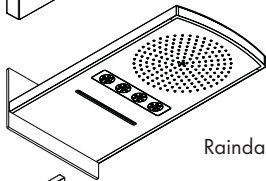

92, 94

Raindance Rainfall 240

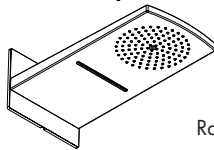

106 - 110

Raindance Rainfall 180

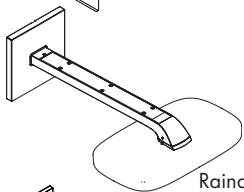

100

Raindance Select E 300

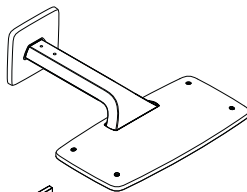

102, 104

Raindance E 420

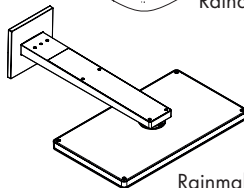

112

Rainmaker Select 460 2jet

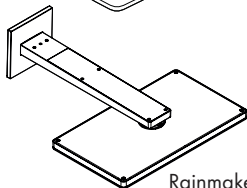

114

Rainmaker Select 460 3jet



- Παραδείγματα εγκατάστασης με διαστάσεις και διαστασιολόγηση των σωλήνων θα βρείτε από τη σελίδα 60.
- Οι διαστάσεις που αναφέρονται στις οδηγίες συναρμολόγησης είναι ιδανικές για άτομα με ύψος περ. 1800 mm και πρέπει, εάν χρειαστεί, να προσαρμοστούν. Στη φάση αυτή προσέξτε ότι με την αλλαγή του ύψους συναρμολόγησης τροποποιείται και το απαιτούμενο ελάχιστο ύψος, οπότε θα προκύψει αλλαγή και στις διαστάσεις σύνδεσης.
- Οι τιμές κατανάλωσης μετρήθηκαν στην πράξη με τα ανάλογα εξαρτήματα μπαταρίας (θερμοστάτης/ αναμικτήρας/εντοιχισμένη βαλβίδα).
- iBox σε συνδυασμό με είσοδο νερού μπανιέρας Exafill με απορροή και εξοπλισμό υπερχείλισης (βλ. Σελίδα 60)



Η αποχετευτική ικανότητα της βαλβίδας εκροής πρέπει να υπερβαίνει τα 1/min.



Βαλβίδα εκροής

iBox σε συνδυασμό με είσοδο νερού μπανιέρας Exafill με απορροή και εξοπλισμό υπερχείλισης

Περιγραφή συμβόλων

X

Κέντρο μπανιέρας / Μέσον της ντουσιέρας

Y

Μέγεθος X = από το μέσον του τόξου σύνδεσης του εύκαμπτου σωλήνα έως το μέσον της εισόδου της μπανιέρας, δια του 2 (ενδεχομένως να πρέπει να προσαρμοστεί στο ράστερ των πλακιδίων).



Ζεστό νερό



Κρύο νερό



Αυτή η λειτουργία διασφαλίζεται από το σημείο κι έπειτα



Σε αυτήν την περιοχή είναι απαραίτητη μία ενίσχυση του τοίχου.



Μόνο ένας χρήστης, όχι δύο ταυτόχρονα



% Εγκαταστήστε τους αγωγούς νερού του καταιονιστήρα σώματος με κλίση.



Μπλοκ ξεπλύματος κομπλέ #15956000



Χωνευτή βαλβίδα



Quattro τετράοδης μετατροπής



Trio Universal βαλβίδα κλεισίματος και εκτροπής



Είσοδος νερού στη μπανιέρα



Τα περιττά στόμια εξόδου πρέπει να στεγανοποιηθούν με ένα τυφλό πώμα. (DN20, 3/4")

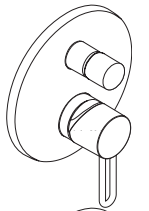

62, 72,
74

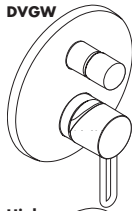

DVGW

60

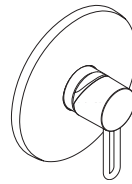

64 - 68,
82

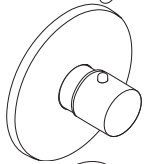

76, 80,
84

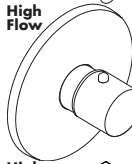

High
Flow

86 - 90,
94, 96,
102 - 112

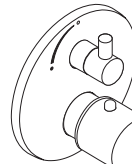

64 - 68,
82

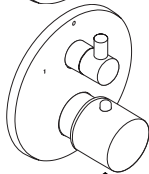

62, 72,
74, 78

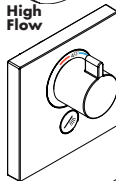

High
Flow

92, 98,
100, 114

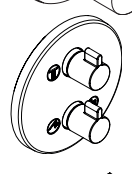

102

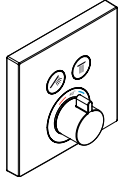

62, 72,
74, 78

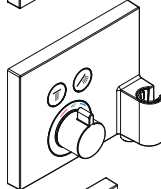

70

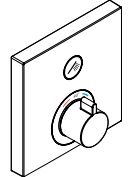

64 - 68

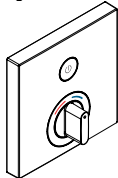

64 - 68

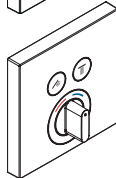

62, 72,
74, 78

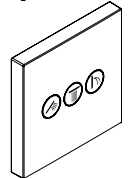

92,
98 - 102,
110 - 114

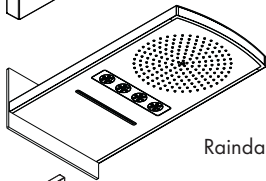

92, 94

Raindance Rainfall 240

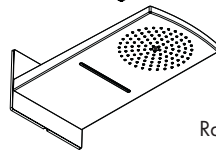

106 - 110

Raindance Rainfall 180

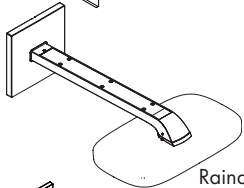

100

Raindance Select E 300

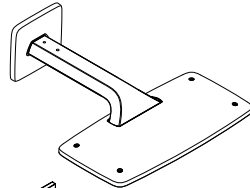

102, 104

Raindance E 420

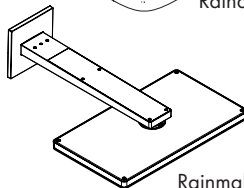

112

Rainmaker Select 460 2jet

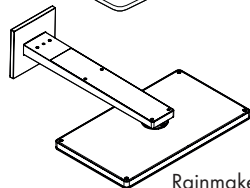

114

Rainmaker Select 460 3jet



- Inštalacijske primere z navedbami mer in dimenzioniranjem cevi najdete od strani 60 dalje.
- V navodilu za montažo navedene mere so idealne za osebe, visoke pribl. 1800 mm, in jih je treba po potrebi prilagoditi. Pri tem morate paziti na to, da se pri spremenjeni montažni višini spremeni tudi minimalna višina in je treba upoštevati spremembo priključnih mer.
- Vrednosti porabe so bile s pripadajočimi armaturami (termostat/mešalni ventil/podometni ventil) izmerjene v pogojih, ki ustrezajo predvideni dejanski uporabi.
- iBox v kombinaciji z Exafill dovodom za kopalno kad z odtočno in pretočno garnituro (glejte stran 60)

Opis simbola

X Sredina kopalne kadi / Sredina pršne kadi

Y Mera Y = sredina loka priključka za cev do sredine dotoka v kad deljeno z 2 (morebiti prilagoditi vzorcu ploščic)

 Topla voda

 Mrzla voda

 Od • je delovanje zagotovljeno.

 V tem območju je potrebno ojačanje stene.

 Mogoč je samo en uporabnik, ne dva istočasno.

 % Položite vodovodne cevi za stranske šobe z naklonom.

 Ventil za vodo, kpl. #15956000

 Podometni ventil

 Quattro
Quattro štiripotna prestavitev

 Trio
Trio Universal zaporni in preklopni ventil

 Vtok v kad

 Izhod, ki ga ne potrebujete, zatesnite s čepom. (DN20, 3/4")

 > 50 l/min
Odtočna kapacitetamora znašati več kot 50 l/min.

 Odtok

 iBox v kombinaciji z Exafill dovodom za kopalno kad z odtočno in pretočno garnituro

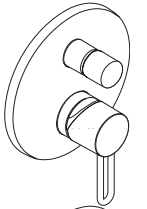

62, 72,
74

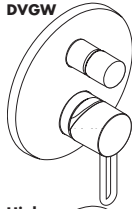

DVGW

60

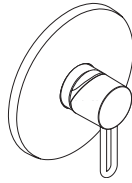

64 - 68,
82

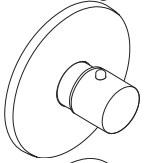

76, 80,
84

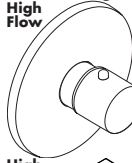

High Flow

86 - 90,
94, 96,
102 - 112

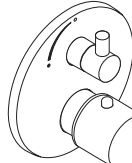

64 - 68,
82

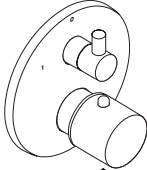

62, 72,
74, 78

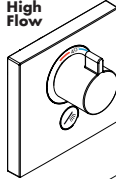

High Flow

92, 98,
100, 114

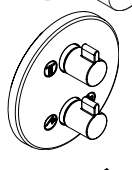

102

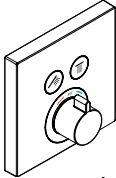

62, 72,
74, 78

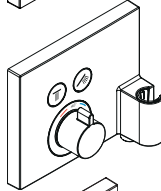

70

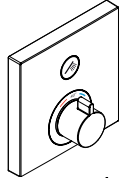

64 - 68

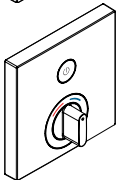

64 - 68

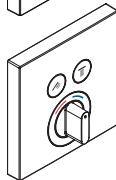

62, 72,
74, 78

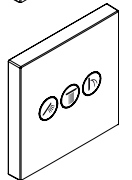

92,
98 - 102,
110 - 114

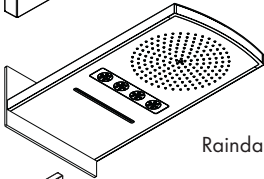

92, 94

Raindance Rainfall 240

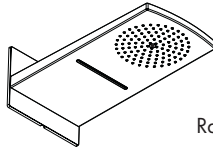

106 - 110

Raindance Rainfall 180

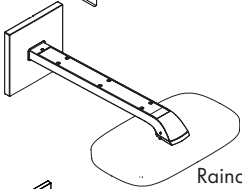

100

Raindance Select E 300

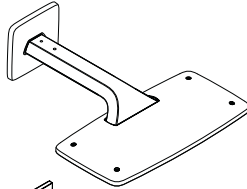

102, 104

Raindance E 420

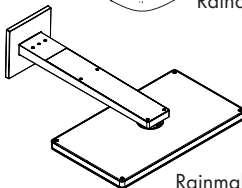

112

Rainmaker Select 460 2jet

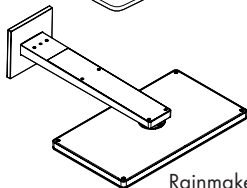

114

Rainmaker Select 460 3jet



- Paigaldusnäited koos mõõtude info ja voolikute suurustega leiate alates leheküljest 60.
- Paigaldusjuhendis esitatud paigaldusmõõdud on ideaalsed u. 1800 mm pikkustele inimestele ning vajadusel tuleb neid kohandada. Seejuures tuleb silmas pidada, et muutunud paigalduskõrguse korral muutub ka minimaalne kõrgus ning tuleb arvestada, et erinevad on ka ühendusmõõdud.
- Tarbimisväärtusi mõõdeti praktikas juurdekuuluvate armatuuridega (termostaat/segisti/krohvalune ventiil).
- iBox ühenduses ära- ja ülevoolugarnituuriga Exafilli vanni sissevooluga (vt lk 60)

Sümbolite kirjeldus

X

Vanni keskoht / Dušivanni kese

Y

Mõõt Y = vooliku seinaväljavoolu keskmet vanniäituri keskele jagatud 2-ga (võimalusel kohandage keraamiliste plaatide asetusega).



Soe vesi



Külm vesi



Alates • on funktsioneerimine garanteeritud



Selles alas tuleb seina tugevdada.



Võimalik on ainult üks funktsioon, mitte kaks korraga.



% Paigaldage kehaduši jaoks vajalikud veetorud kaldega.



Loputusplokk kpl. #15956000



peiteklapp



Quattro-liitmik



Katkestus- ja ümberlülitusklapp Trio Universal



Vanni kraan



Mittevajalik väljavool tuleb sulgeda korgiga. (DN20, 3/4")



Äravoolu jõudlus peab olema suurem kui 50 l/min.



Äravool



iBox ühenduses ära- ja ülevoolugarnituuriga Exafilli vanni sissevooluga

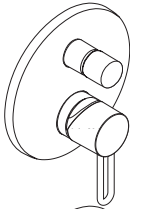

62, 72,
74

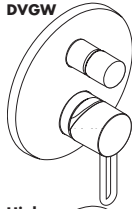

DVGW

60

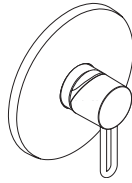

64 - 68,
82

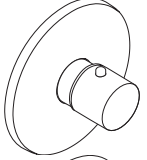

76, 80,
84

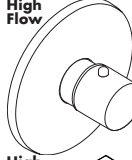

High
Flow

86 - 90,
94, 96,
102 - 112

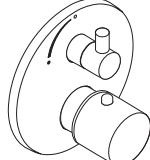

64 - 68,
82

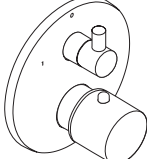

62, 72,
74, 78

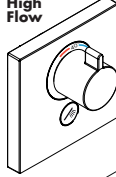

High
Flow

92, 98,
100, 114

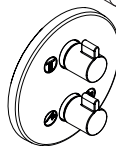

102

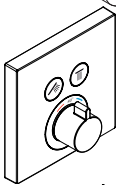

62, 72,
74, 78

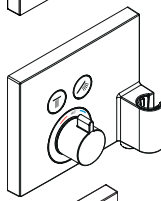

70

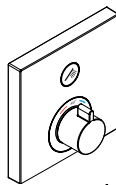

64 - 68

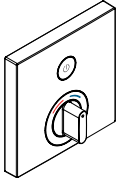

64 - 68

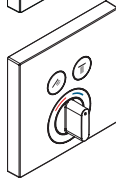

62, 72,
74, 78

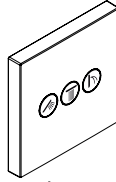

92,
98 - 102,
110 - 114

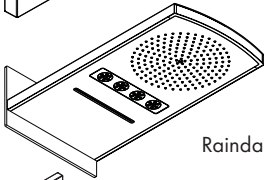

92, 94

Raindance Rainfall 240

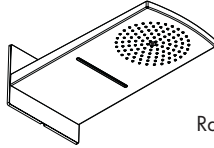

106 - 110

Raindance Rainfall 180

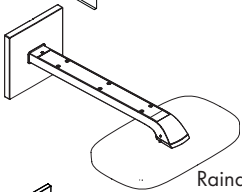

100

Raindance Select E 300

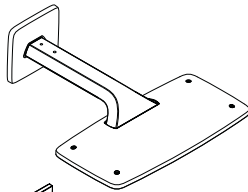

102, 104

Raindance E 420

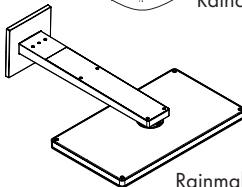

112

Rainmaker Select 460 2jet

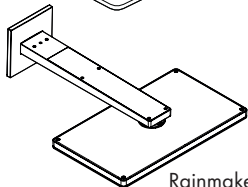

114

Rainmaker Select 460 3jet



- Uzstādīšanas piemēri ar izmēriem un vadu izkārtojumu atrodami, sākot no 60 lappuses.
- Montāžas instrukcijās dotie montāžas izmēri ir ideāli piemēroti personām, kuru augums ir apm. 1800 mm. Nepieciešamības gadījumā šie izmēri ir jāpielāgo. Šeit ir jāņem vērā, ka mainoties montāžas augstumam, mainās arī minimālais augstums, un jāņem vērā arī pieslēgšanas izmēru izmaiņas.
- Patēriņš ir noteikts praktiski ar atbilstošu armatūru (termostats/maisītājs/zemapmetuma vārsts).
- iBox kombinācijā ar Exafill vannas ieklūdi ar noplūdes un pārplūdes garnitūru (skat. lpp. 60)

Simbolu nozīme



Vannas vidus / Dušas paliktna vidus



Izmērs Y = šļūtenes savienojuma loka vidu līdz vannas ietece vidum dalīt ar 2 (eventuāli piemērot flīžu rakstam)



Siltais ūdens



Aukstais ūdens



No • funkcija nodrošināta



Šajā zonā ir nepieciešams pastiprināt sienu.



Iespējams tikai viens patērētājs, nedrīkst vienlaikus būt divi patērētāji.



Montēt ūdens cauruļvadus sānu (ķermeņa) dušām ar atbilstošu slīpumu.



Skalošanas bloks, kompl. #15956000



Zemapmetuma ventilis



Četrvirzienu pārslēgs



Trīsvirzienu universālais noslēgvārsts un pārslēdzējvārsts



Vannas tekne



Neizmantoto izteku aizbāzt ar aizbāzni. (DN20, 3/4")



Notecei veikspējai jābūt vairāk nekā 50 l/min.



Notece



iBox kombinācijā ar Exafill vannas ieklūdi ar noplūdes un pārplūdes garnitūru

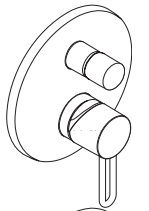

62, 72,
74

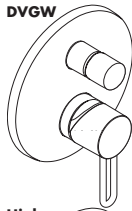

DVGW

60

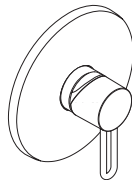

64 - 68,
82

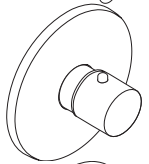

76, 80,
84

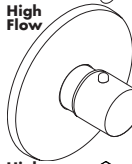

High
Flow

86 - 90,
94, 96,
102 - 112

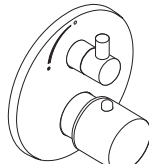

64 - 68,
82

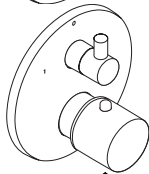

62, 72,
74, 78

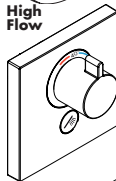

High
Flow

92, 98,
100, 114

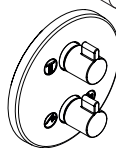

102

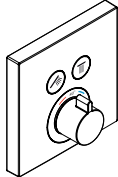

62, 72,
74, 78

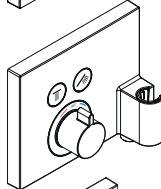

70

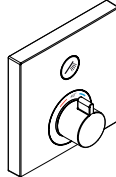

64 - 68

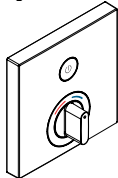

64 - 68

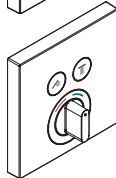

62, 72,
74, 78

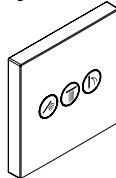

92,
98 - 102,
110 - 114

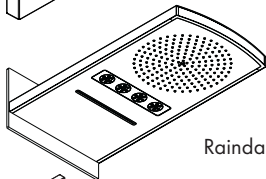

92, 94

Raindance Rainfall 240

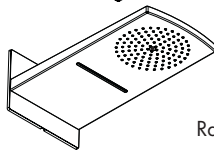

106 - 110

Raindance Rainfall 180

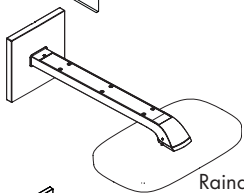

100

Raindance Select E 300

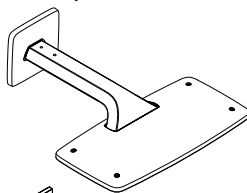

102, 104

Raindance E 420

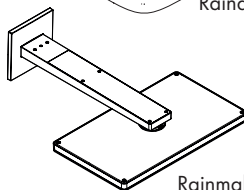

112

Rainmaker Select 460 2jet

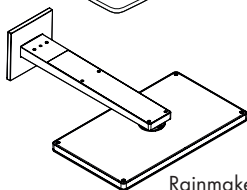

114

Rainmaker Select 460 3jet



- Primeri instalacija sa veličinama i dimenzijama vodova mogu se naći od stranice 60 nadalje.
- Montažne dimenzije navedene u uputstvu za montažu idealne su za osobe visine oko 1800 mm, tako da se po potrebi moraju prilagoditi konkretnoj visini korisnika. Pri tome treba uzeti u obzir da se prilikom promene montažne visine menja i minimalna visina kao i da se u tom slučaju mora uvažiti i promena priključnih dimenzija.
- Vrednosti potrošnje su u praksi merene sa pripadajućim armaturama (termostat/mešač/uzidni ventil).
- iBox u kombinaciji sa Exafill dotokom kade sa odvodnom i prelivnom garniturom (vidi stranu 60)

Opis simbola

X

Sredina kade / Sredina tuš-kada

Y

Mera Y = sredina priključnog luka creva do sredine dotoka kade podeljeno sa 2 (eventualno prilagoditi rasteru pločica).



Topla voda



Hladna voda



Od • je funkcija zagarantovana.



U ovoj oblasti je potrebno ojačanje zida.



Moguće je koristiti samo jedan potrošač, nikako dva istovremeno!



% Položite vodovodne cevi za bočni tuš s nagibom.



kompletan blok #15956000



Uzidni ventil



Quattro četverostruki preusmerivač



Trio Universal ventil za zatvaranje i preklopni ventil



Dotok kade



Izlaz koji se ne koristi, mora se zatvoriti slepim čepom. (DN20, 3/4")



Kapacitet odvoda mora biti veći od 50 l/min.



Ispust



iBox u kombinaciji sa Exafill dotokom kade sa odvodnom i prelivnom garniturom

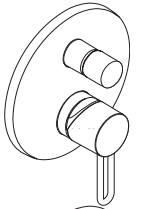

62, 72,
74

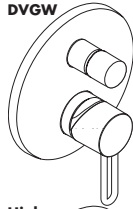

DVGW

60

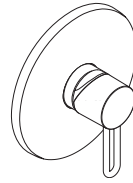

64 - 68,
82

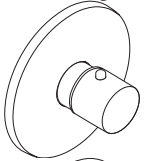

76, 80,
84

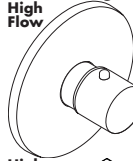

High
Flow

86 - 90,
94, 96,
102 - 112

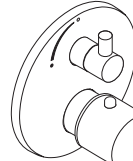

64 - 68,
82

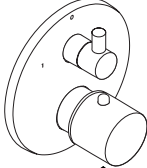

62, 72,
74, 78

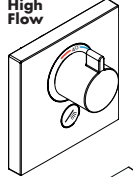

High
Flow

92, 98,
100, 114

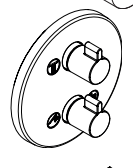

102

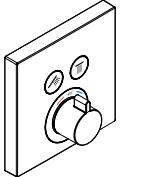

62, 72,
74, 78

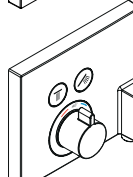

70

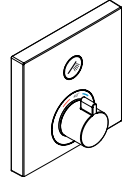

64 - 68

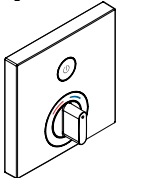

64 - 68

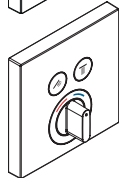

62, 72,
74, 78

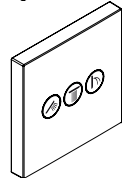

92,
98 - 102,
110 - 114

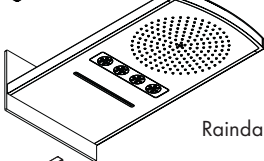

92, 94

Raindance Rainfall 240

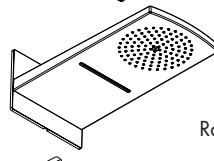

106 - 110

Raindance Rainfall 180

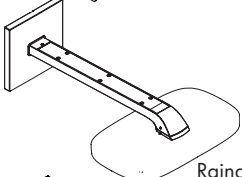

100

Raindance Select E 300

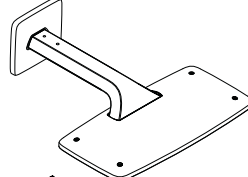

102, 104

Raindance E 420

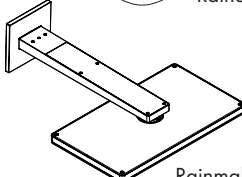

112

Rainmaker Select 460 2jet

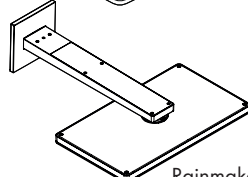

114

Rainmaker Select 460 3jet



- Installasjonseksempel med målangivelser og ledningsdimensjoner finns fom. side 60.
- Monteringsmål i monteringsveiledningen er beregnet for personer som er omtrent 1800 mm høye, målene skal eventuell tilpasses om nødvendig. Her skal man passe på at ved endrede monteringsmålene blir minstehøyden endret, og det må tas hensyn til de endrede tilkoblingsmålene.
- Forbruksverdiene måles ved normal bruk med tilhørende armatur (temostat/blandebatteri/innmurt ventil).
- iBox i kombinasjon med Exfill karinnløp med avløps- og overflytgarnityr (se side 60)

Symbolbeskrivelse

X Midten av badekaret / Midten på dusjkar

Y Mål Y = Midten til slangetilkoblingsbue t.o.m. badekarinnløp delt på 2 (eventuelt skal fliseraster tilpasses).

 Varmtvann

 Kaldtvann

 F.o.m. • er funksjonen garantert

 I dette området skal veggen forsterkes.

 Kun en forbruker mulig, ikke to samtidig.

 Vannledninger for sidedusjer installeres med fall.

 Spyleblokk kpl. #15956000

 Innfelt ventil

 Quattro fire-veis omstilling

 Trio universal stenge- og omstillingsventil

 Innløp badekar

 Utgangen som ikke brukes kan tettes med en blindplugg. (DN20, 3/4")

 Avløp ytelse skal være mer enn 50 l/min.

 Avløp

 iBox i kombinasjon med Exfill karinnløp med avløps- og overflytgarnityr

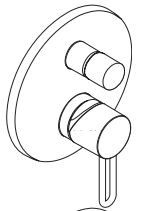

62, 72,
74

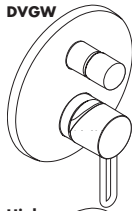

DVGW

60

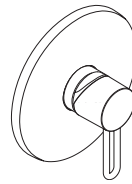

64 - 68,
82

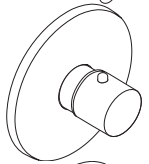

76, 80,
84

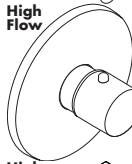

High
Flow

86 - 90,
94, 96,
102 - 112

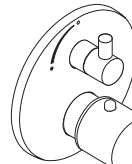

64 - 68,
82

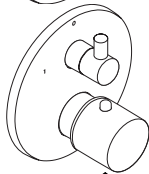

62, 72,
74, 78

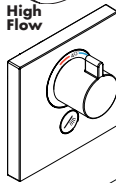

High
Flow

92, 98,
100, 114

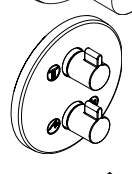

102

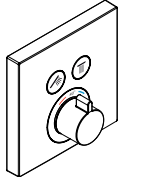

62, 72,
74, 78

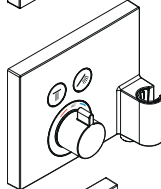

70

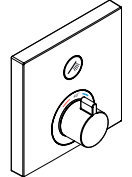

64 - 68

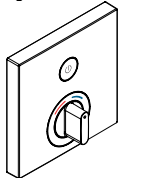

64 - 68

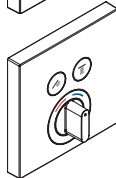

62, 72,
74, 78

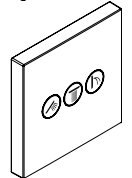

92,
98 - 102,
110 - 114

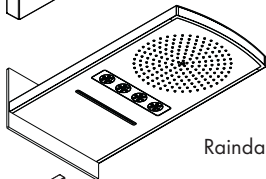

92, 94

Raindance Rainfall 240

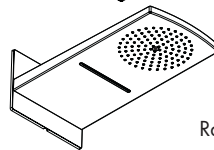

106 - 110

Raindance Rainfall 180

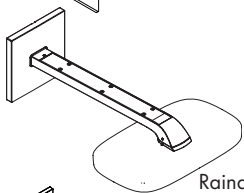

100

Raindance Select E 300

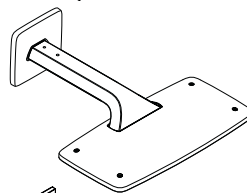

102, 104

Raindance E 420

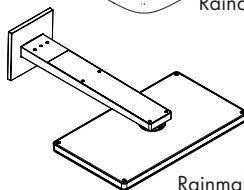

112

Rainmaker Select 460 2jet

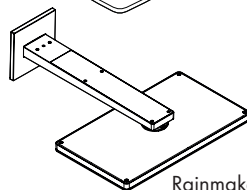

114

Rainmaker Select 460 3jet



- Примери за инсталация с данни за размери и определяне на размерите на тръбопроводите можете да намерите от стр. 60 нататък.
- Посочените в ръководството за монтаж монтажни мерки са идеални за лица с ръст от прибл. 1800 мм и трябва съответно да се пригодят. При това обърнете внимание на това, при променена монтажна височина се променя минималната височина и трябва да бъде взета под внимание промяната на присъединителните размери.
- Стойностите за разхода бяха измерени във връзка с практиката със съответните арматури (термостат/смесител/клапан за полагане в мазилката).
- iVox в комбинация с вход за вана Exafill с гарнитура за изтичане и преливане. (вижте стр. 60)



Мощността на изтичане трябва да бъде повече от 50 л/мин.



Отвеждане

iVox в комбинация с вход за вана Exafill с гарнитура за изтичане и преливане.

Описание на символите

X Среда на ваната / Среда на коритото на душ-кабината

Y Мярка Y = Среда на присъединителното коляно на маркуча до входа на ваната разделено на 2 (евентуално изравнете към растера на плочките).



Топла вода



Студена вода



От • функцията е гарантирана.



В тази област е необходимо подсилване на стената.



Възможен е само един консуматор, не два едновременно.



% Водопроводните линии за страничните разпръскватели полагайте с наклон.



Изплаквач блок компл. #15956000



Клапан за мазилка



Четирипътно превключване Quattro



Спирателен и превключващ клапан Trio Universal



Вход за вана



Излишният извод може да се уплътни с глуха пробка. (DN20, 3/4")

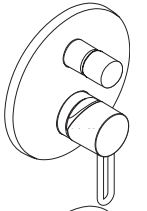

62, 72,
74

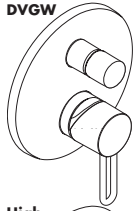

DVGW

60

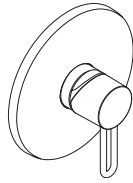

64 - 68,
82

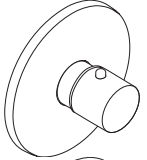

76, 80,
84

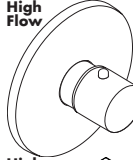

High
Flow

86 - 90,
94, 96,
102 - 112

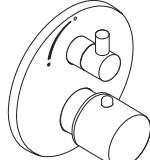

64 - 68,
82

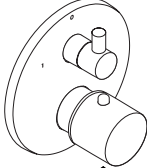

62, 72,
74, 78

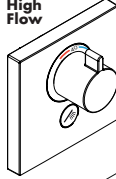

High
Flow

92, 98,
100, 114

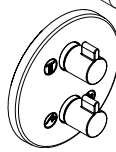

102

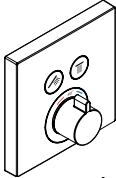

62, 72,
74, 78

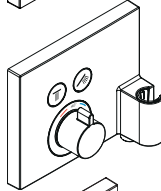

70

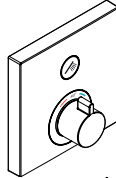

64 - 68

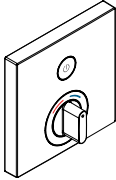

64 - 68

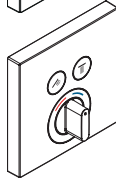

62, 72,
74, 78

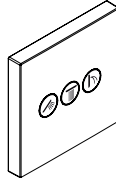

92,
98 - 102,
110 - 114

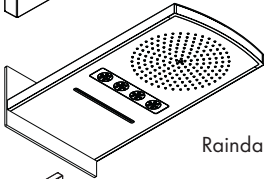

92, 94

Raindance Rainfall 240

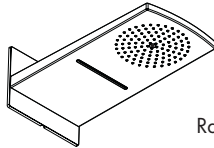

106 - 110

Raindance Rainfall 180

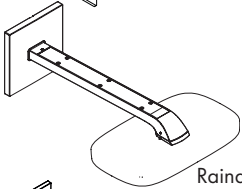

100

Raindance Select E 300

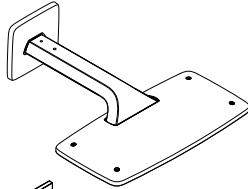

102, 104

Raindance E 420

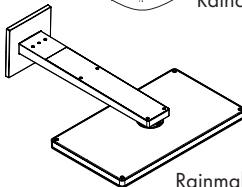

112

Rainmaker Select 460 2jet

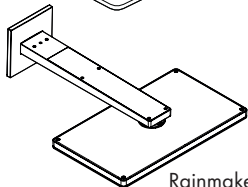

114

Rainmaker Select 460 3jet



iBox-i në kombinim me në garniturë dalëse dhe rrjedhëse Exafill hyrjen e vaskës

- Shembujt e instalimit me përmasat dhe dimensionimet e tubacioneve mund t'i gjeni nga faqja 60.
- Përmasat e montimit të cekura në udhëzimin teknik të montimit janë ideale për persona me gjatësi afro 1800 mm (180 cm) dhe eventualisht duhen përshtatur. Këtu duhet pasur parasysh që me ndryshimin e lartësisë së montimit, ndryshon edhe lartësia e cekur minimale si dhe ndryshimi i përmasave të lidhjeve.
- Vlerat e konsumit janë matur praktikisht me pajisje përkatëse të valvulave/pajisjeve të ujit (termostati / miksuksi / ventili nën sipërfaqës suvuar).
- iBox-i në kombinim me në garniturë dalëse dhe rrjedhëse Exafill hyrjen e vaskës (shih faqen 60)

Përshkrimi i simbolit

X

Mesi i vaskës / Mesi i vaskës së dushit

Y

Përmasa Y = mesi i harkut të lidhjes së zorrës deri tek mesi i hyrjes së vaskës pjesëtim për 2 (eventualisht i duhet përshtatur këndit të pllakave të murit).



Uji i ngrohtë



Uji i ftohtë



Nga • është i mundur funksioni.



Në këtë zonë është i nevojshëm një përforsim i murit.



Ekziston mundësia vetëm për një konsumator, jo për dy njëkohësisht.



Vendosni tubacionet e ujit për spërkatëset anësore me pjerrësi.



Blloku shpëlarës komplet #15956000



Ventili i suvajës



Valvul devijuese Quattro me katër drejtime



Valvul universale Trio për bllokim dhe devijim



Vrima për mbushjen e vaskës



Dalja që nuk nevojitet duhet izoluar me tapë qorre. (DN20, 3/4")



Kapaciteti i shkarkimit duhet të jetë më shumë se 50 l/minutë.



Shkarkimi

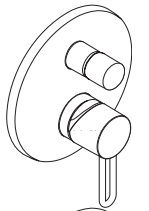

62, 72,
74

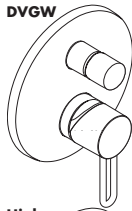

DVGW

60

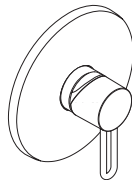

64 - 68,
82

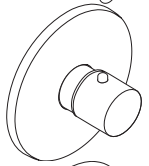

76, 80,
84

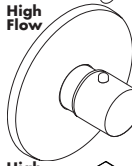

High Flow

86 - 90,
94, 96,
102 - 112

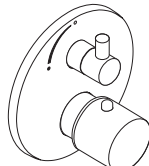

64 - 68,
82

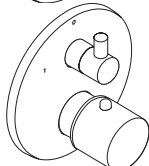

62, 72,
74, 78

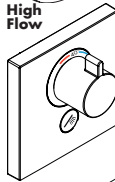

High Flow

92, 98,
100, 114

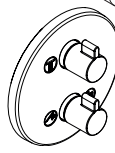

102

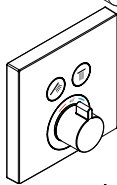

62, 72,
74, 78

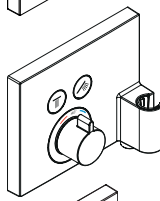

70

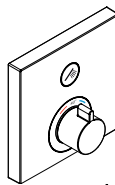

64 - 68

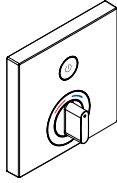

64 - 68

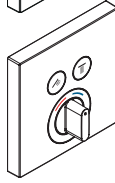

62, 72,
74, 78

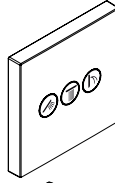

92,
98 - 102,
110 - 114

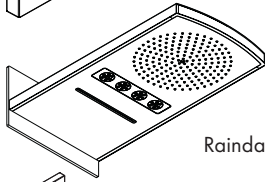

92, 94

Raindance Rainfall 240

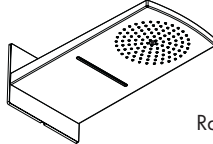

106 - 110

Raindance Rainfall 180

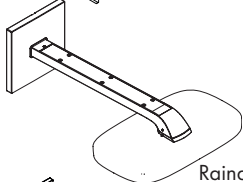

100

Raindance Select E 300

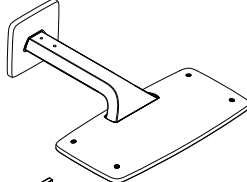

102, 104

Raindance E 420

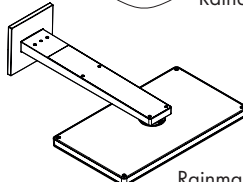

112

Rainmaker Select 460 2jet

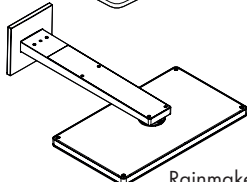

114

Rainmaker Select 460 3jet





- يوجد بدءاً من صفحة 60 أمثلة للتركيب بمقاسات وطرق عمل بعض الوصلات.
- تعد أبعاد التركيب الواردة في إرشادات التركيب هذه مثالية بالنسبة للأشخاص الذين يبلغ طولهم حوالي 1800 مم ويمكن تغيير الأبعاد عند الحاجة. وبالتالي سينغير الحد الأدنى للارتفاع في حالة تغيير ارتفاع التركيب، مما يعني الأخذ في الاعتبار تغيير أبعاد التوصيل.
- تم قياس قيم الاستهلاك طبقاً للخبرة العملية في استعمال خلطات المياه الخاصة بذلك (ترموسنات/خلط/صمام تحت الملاط).
- وحدة "iBox" مع وحدة التدفق بالحوض من النوع "Exafill" مع لوازم تصريف الماء وتصريف تدفق المياه. (راجع صفحة 60)

وصف الرمز

منتصف حوض الاستحمام / بانينو مزود بدش
في المنتصف **X**

البعد γ = مركز مرفق مخرج حائط الخرطوم
إلى مركز حشوة الحمام مقسوماً على 2 (مطابق
لشكل البلاطة إن أمكن). **Y**

ماء دافئ 

ماء بارد 

من • الوظيفة مضمونة. 

يلزم هذا في النطاق وجود تقوية للحائط. 

لا يمكن القيام بأكثر من وظيفة واحدة. 

قم بتركيب مواسير المياه للدش العادي المنحدر. 

قارنة وحدة الغسل #15956000 

صمام التدفق 

تغيير مسار رباعي كواترو 

صمام حجز وتغيير تريبو يونيفرسال 

مدخل مياه للبانينو 

قم بسد المنفذ غير المستخدم. (DN20, 3/4") 

يجب أن تكون قدرة الصرف أكبر من 50 لتر/دقيقة 

تصريف 

وحدة "iBox" مع وحدة التدفق بالحوض من النوع "Exafill" مع لوازم تصريف الماء وتصريف تدفق المياه. 

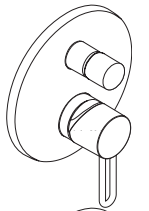

62, 72,
74

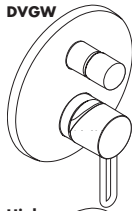

DVGW

60

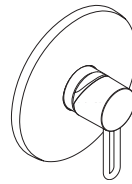

64 - 68,
82

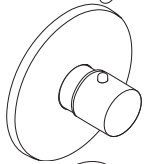

76, 80,
84

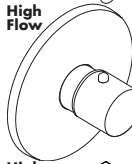

High Flow

86 - 90,
94, 96,
102 - 112

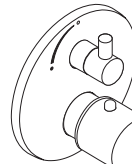

64 - 68,
82

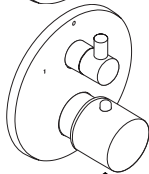

62, 72,
74, 78

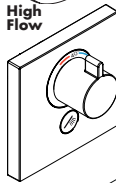

High Flow

92, 98,
100, 114

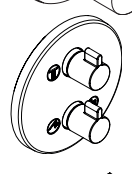

102

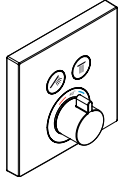

62, 72,
74, 78

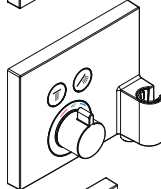

70

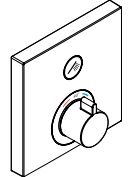

64 - 68

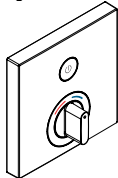

64 - 68

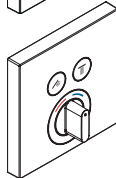

62, 72,
74, 78

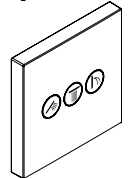

92,
98 - 102,
110 - 114

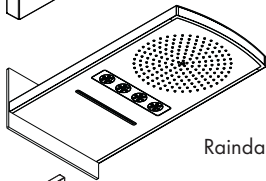

92, 94

Raindance Rainfall 240

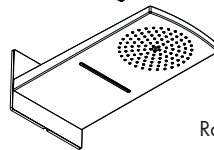

106 - 110

Raindance Rainfall 180

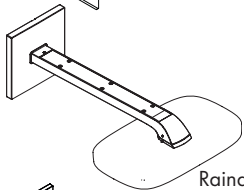

100

Raindance Select E 300

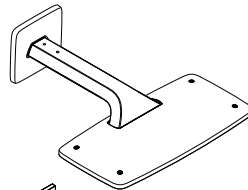

102, 104

Raindance E 420

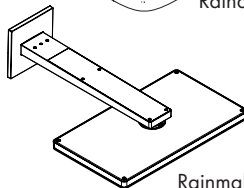

112

Rainmaker Select 460 2jet

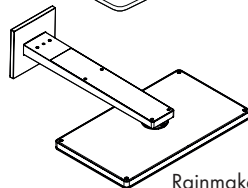

114

Rainmaker Select 460 3jet



- Felszerelési példák méreteikkel és vezeték- dimenzió- nálással az 60 oldalról kezdődően találhatóak.
- A szerelési útmutatóban megadott szerelési méretek kb. 1800 mm testmagasságú személyeknek alkalmasak, és ennek megfelelően átméretezendők. Itt arra kell ügyelni, hogy az átméretezett szerelési magasságnál megváltozik a minimális magasság és figyelembe kell venni a csatlakozó méreteinek változását.
- A fogyasztási értékeket, a gyakorlathoz közel álló módon, a hozzátartozó csaptelepekkel (termosztát/ keverő csaptelep/vakolat alatti szelep) mértük.
- iBox, valamint Exafill kádtöltő, le- és túlfogyó kombinációja (lásd a oldalon 60)



iBox, valamint Exafill kádtöltő, le- és túlfogyó kombinációja

Szimbólumok leírása

X

A kád közepe / Zuhanytálca közepe

Y

Y méret = a csőcsatlakozó közepétől a kádtöltő befolyócső közepéig, osztva kettővel (szükség esetén a csempe kiosztásához igazítva).



Melegvíz



Hidegvíz



A • -től működik az adott funkció.



Ezen a területen a fal megerősítésére van szükség.



Egyidejűleg csak egy fogyasztót lehet használni, két fogyasztó (zuhanyrózsa, oldalzuhanyok) egyszerre nem tud működni.



Az oldalzuhanyokhoz a vízvezeték lejtéssel ajánlott beszerezni.



Öblítőblokk csatlakozó #15956000



Falsík alatti szelep



Quattro négy-utas átalakító



Trio univerzális záró- és váltószelep



Kádbevezetés



A fölösleges kimenetet vakdugóval kell lezárni. (DN20, 3/4")



A lefolyó teljesítményének 50l/percnél magasabbnak kell lenni



Lefolyó

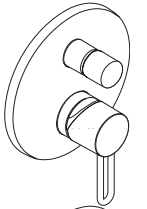

62, 72,
74

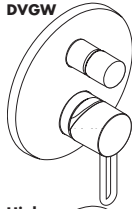

DVGW

60

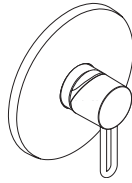

64 - 68,
82

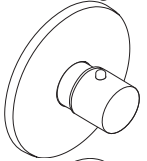

76, 80,
84

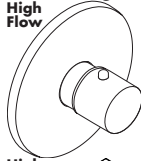

High
Flow

86 - 90,
94, 96,
102 - 112

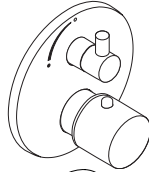

64 - 68,
82

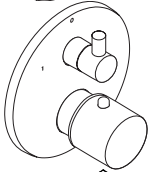

62, 72,
74, 78

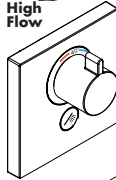

High
Flow

92, 98,
100, 114

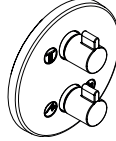

102

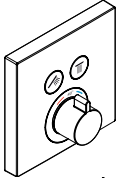

62, 72,
74, 78

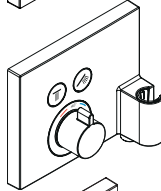

70

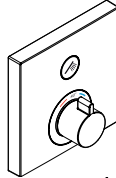

64 - 68

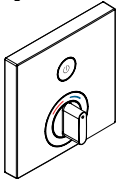

64 - 68

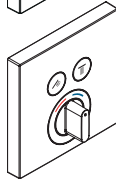

62, 72,
74, 78

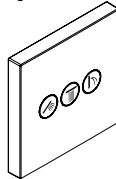

92,
98 - 102,
110 - 114

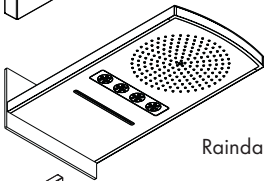

92, 94

Raindance Rainfall 240

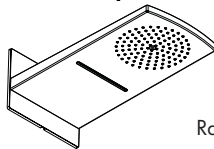

106 - 110

Raindance Rainfall 180

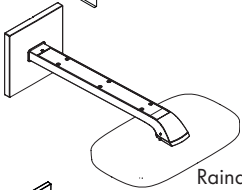

100

Raindance Select E 300

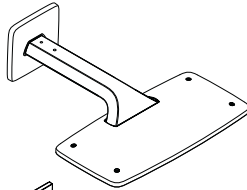

102, 104

Raindance E 420

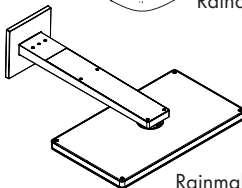

112

Rainmaker Select 460 2jet

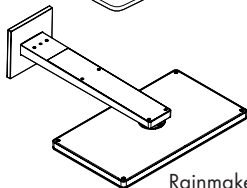

114

Rainmaker Select 460 3jet

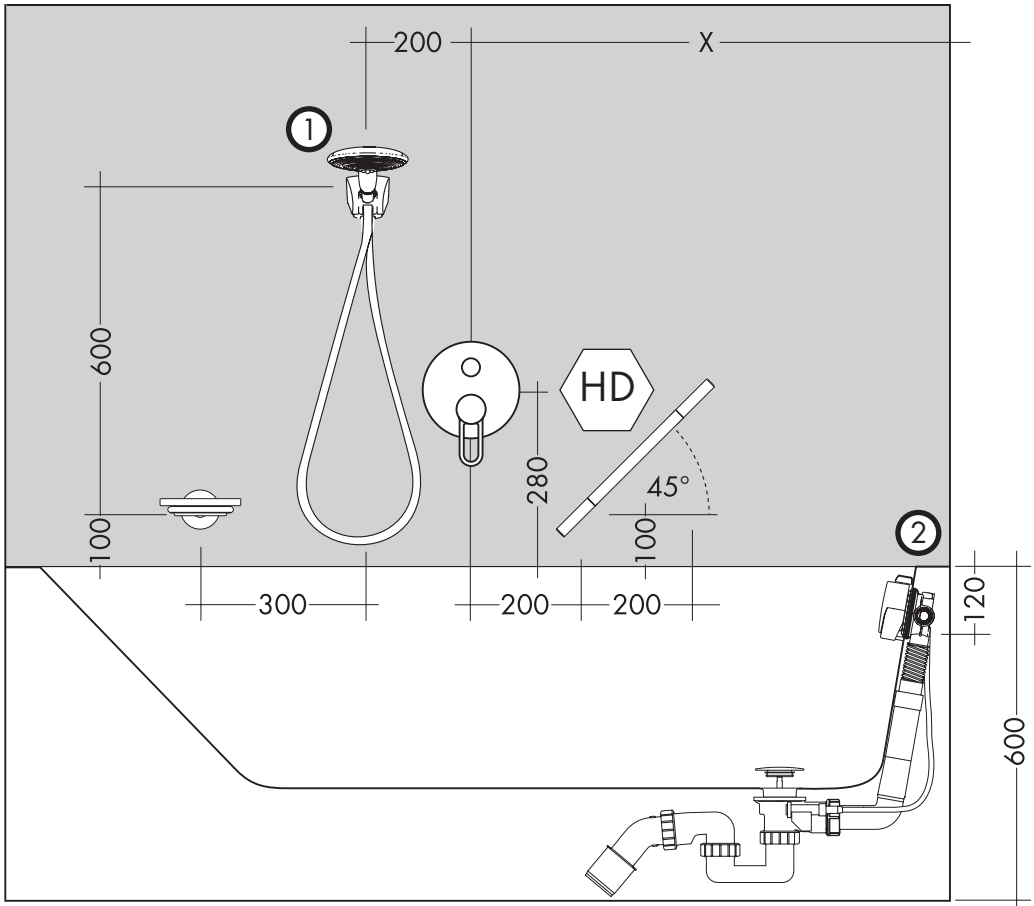
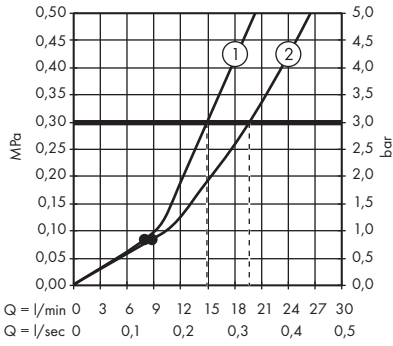
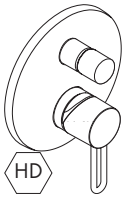

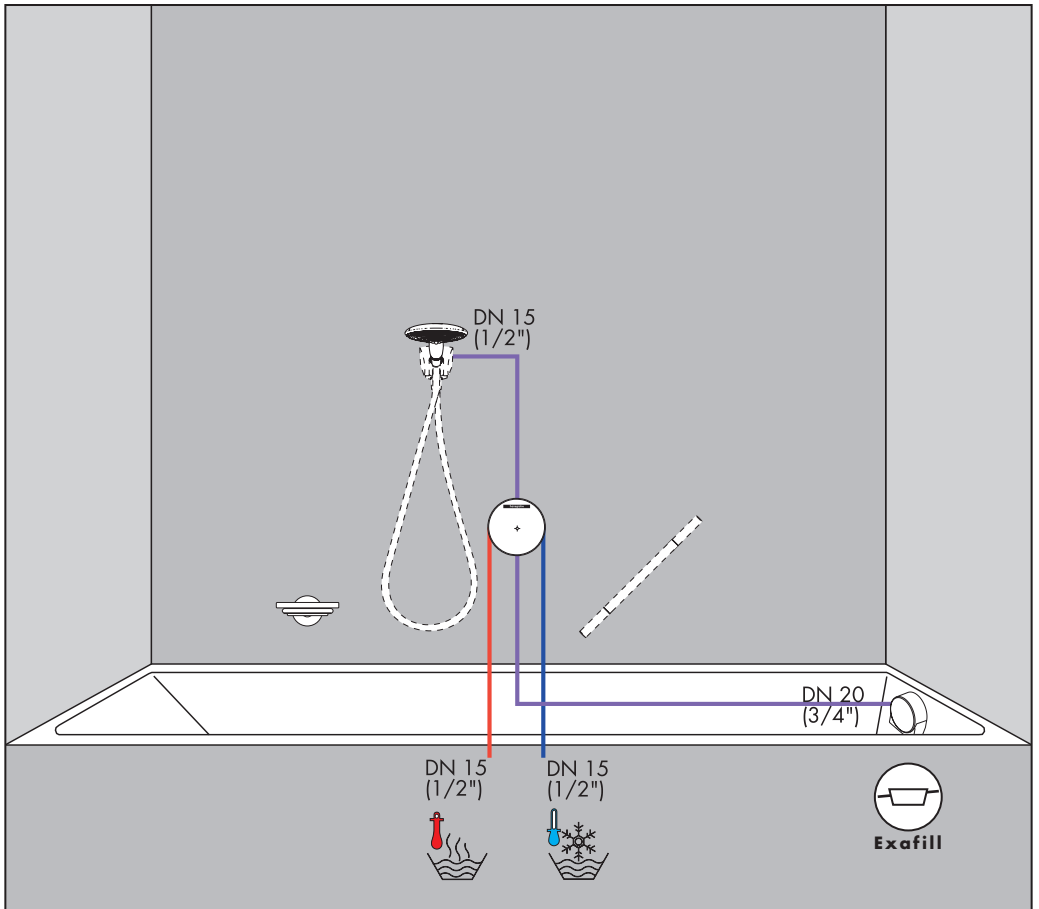

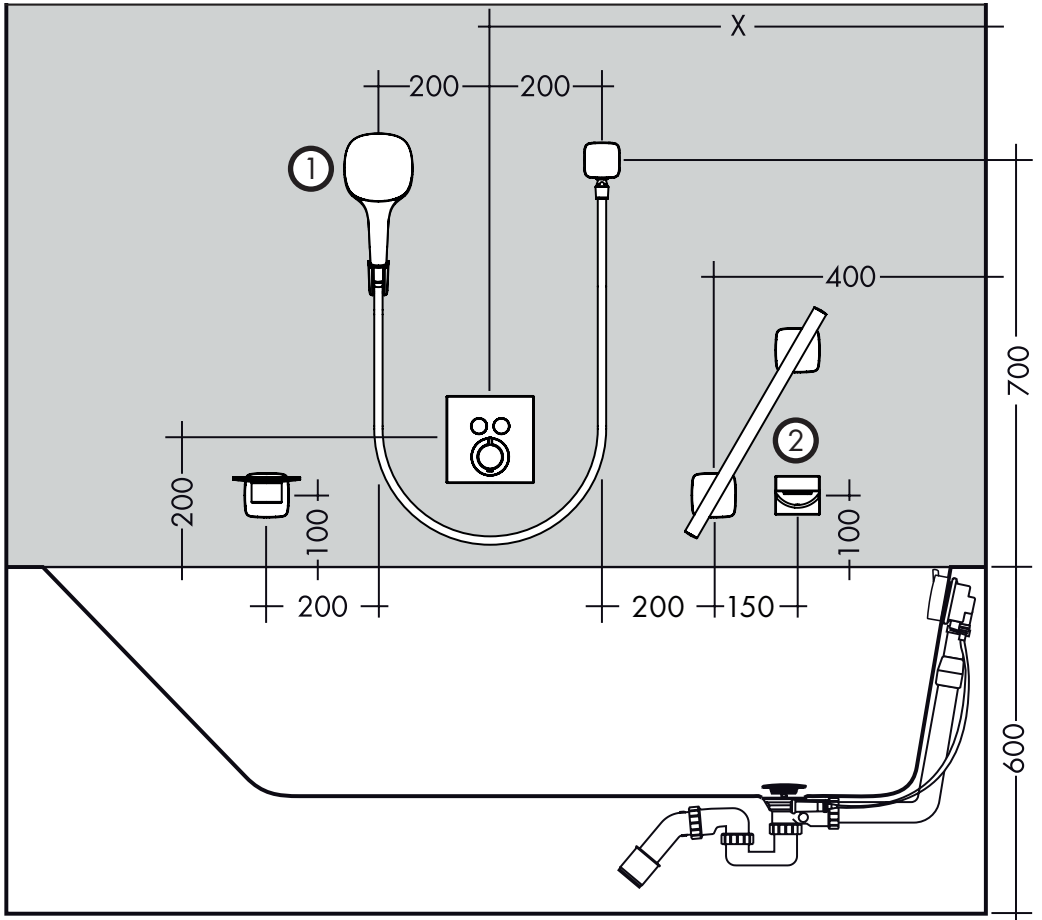
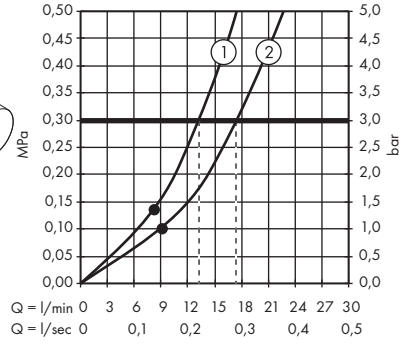
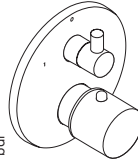
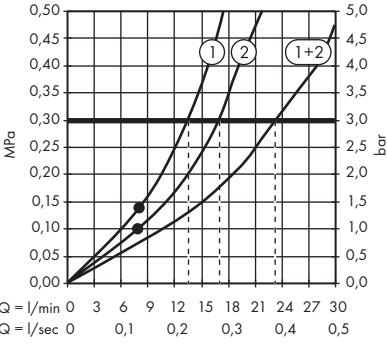
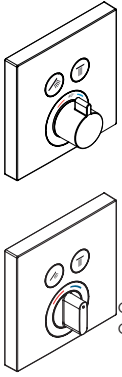

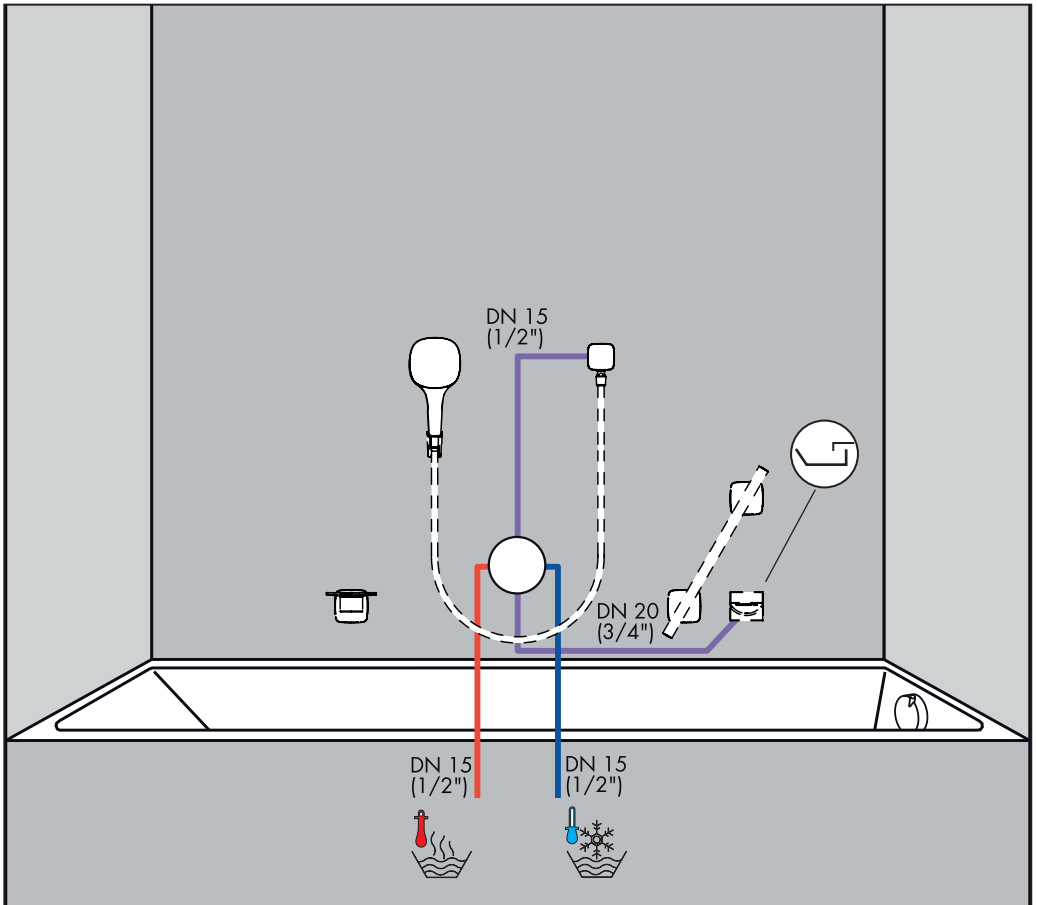
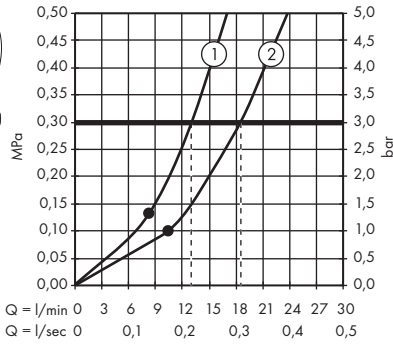
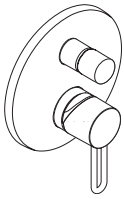

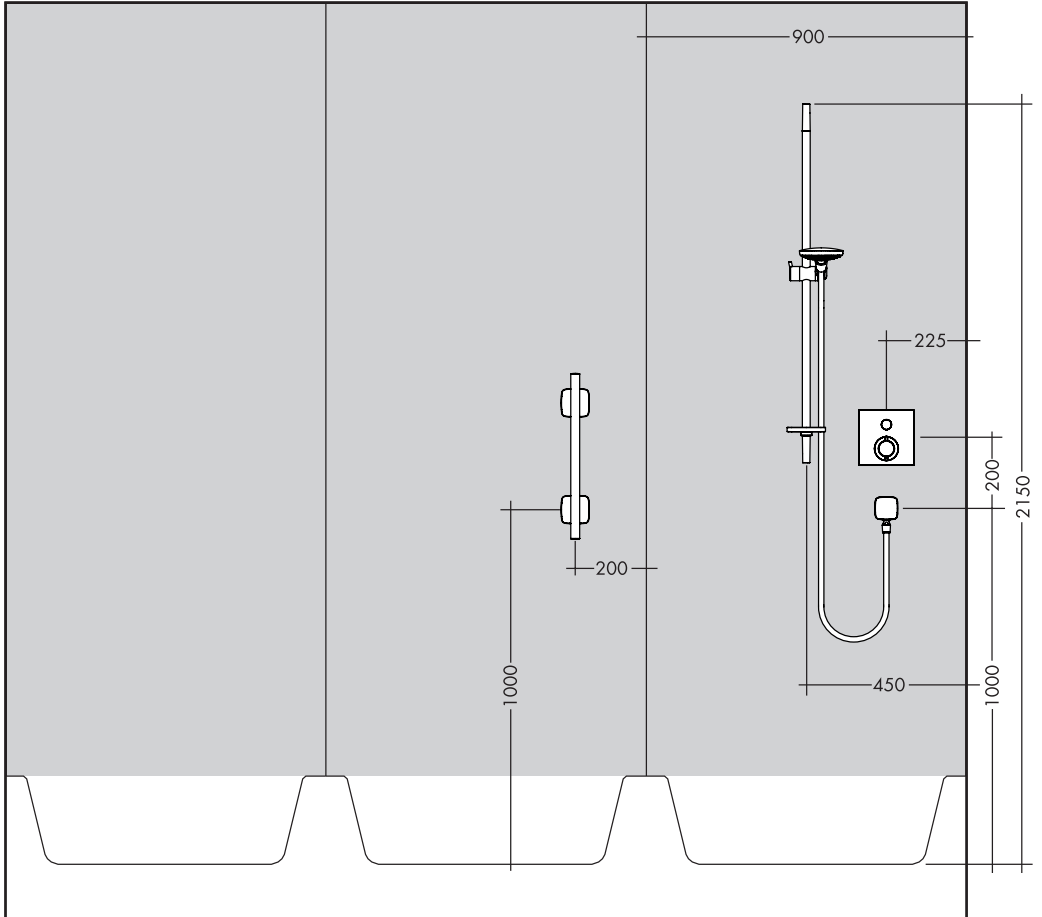
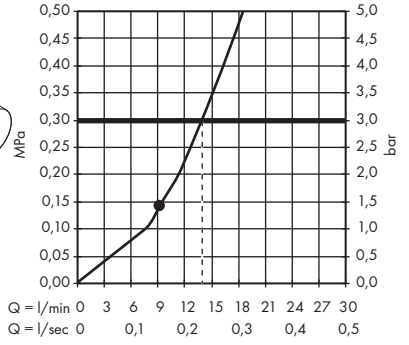
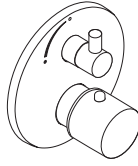
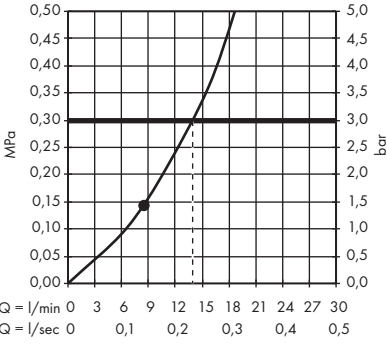
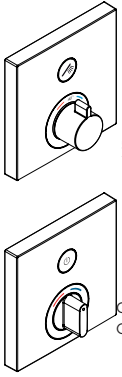

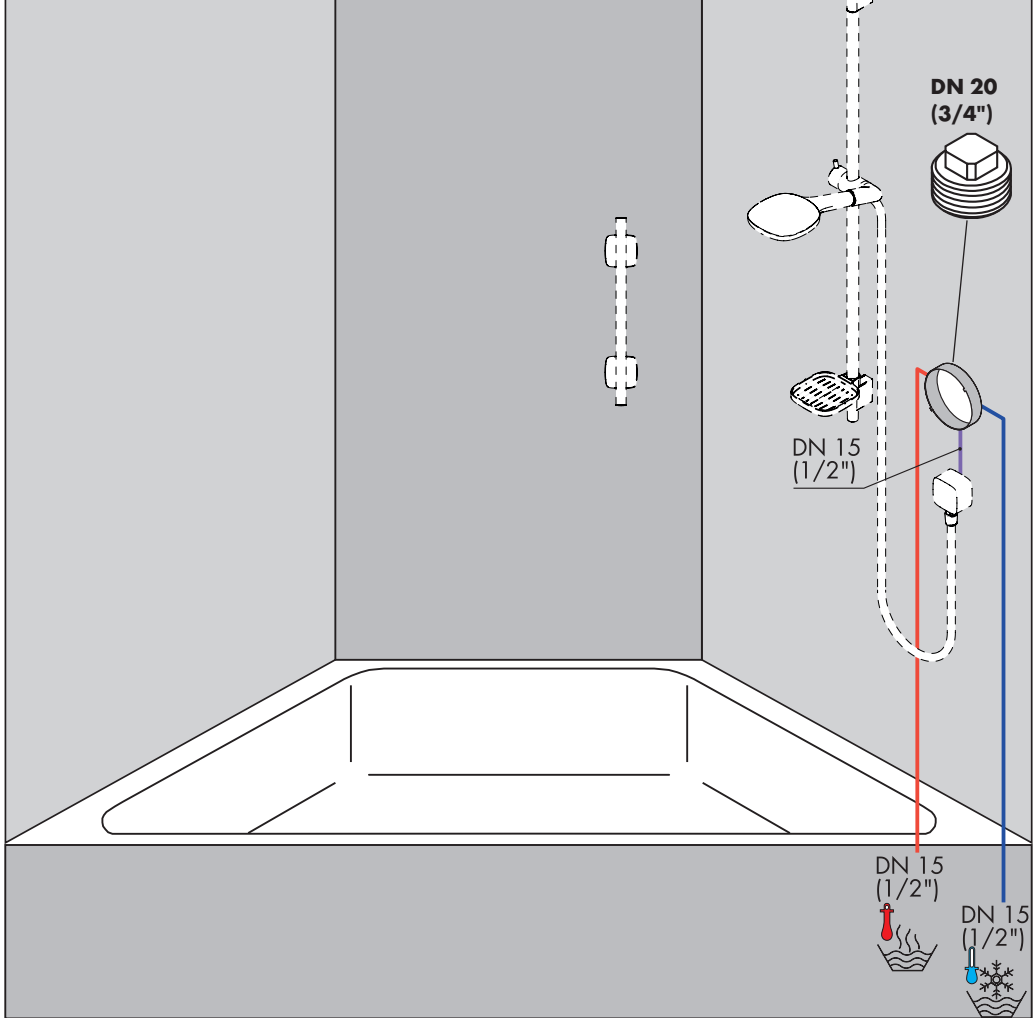
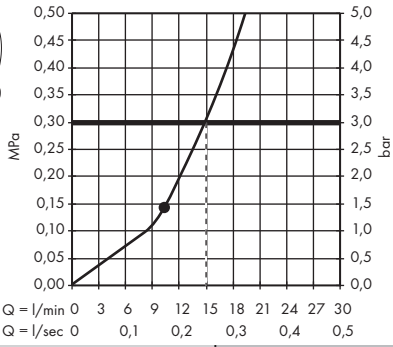
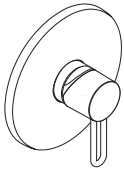

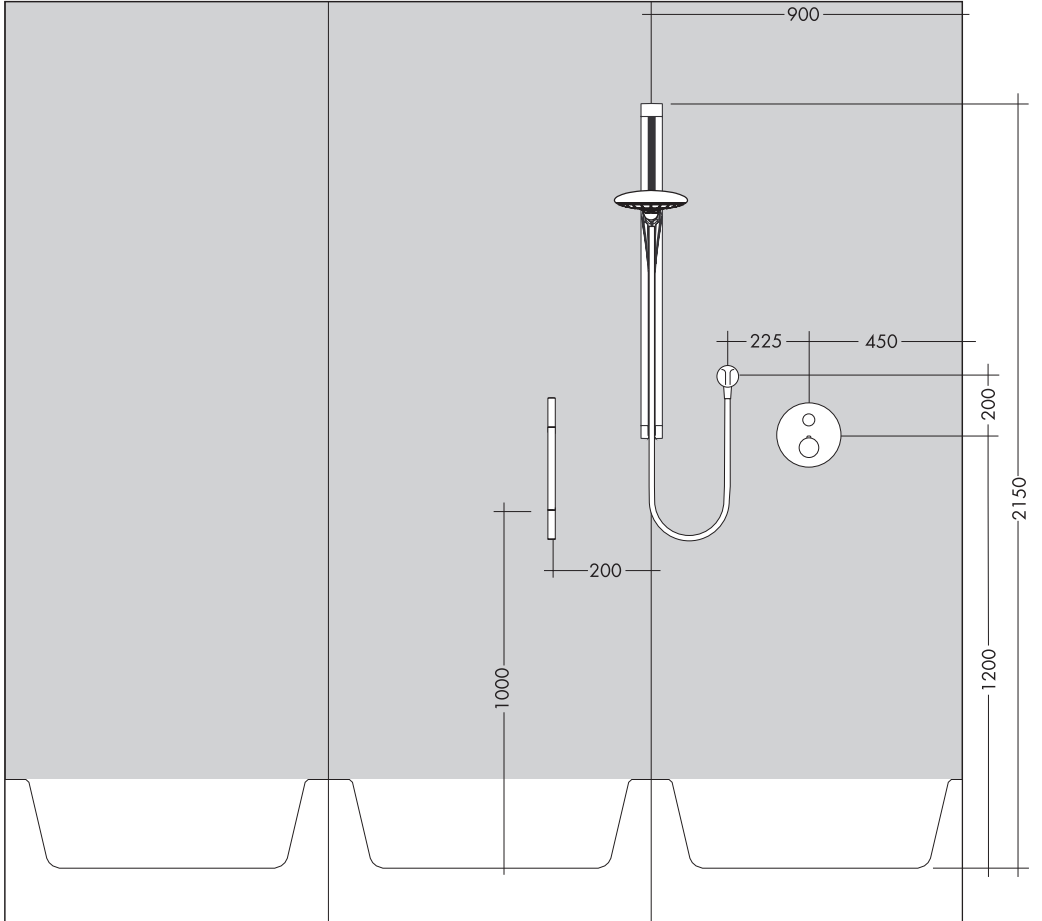
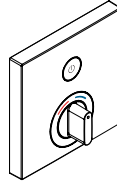
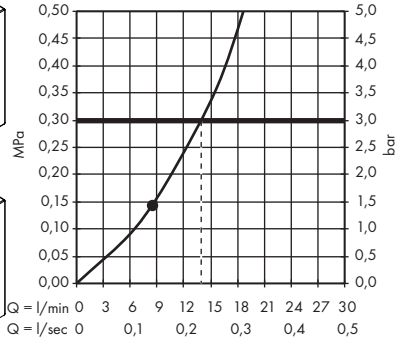
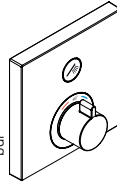
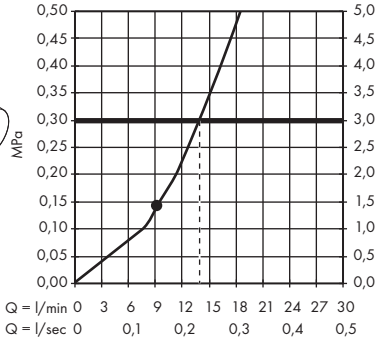
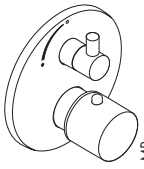

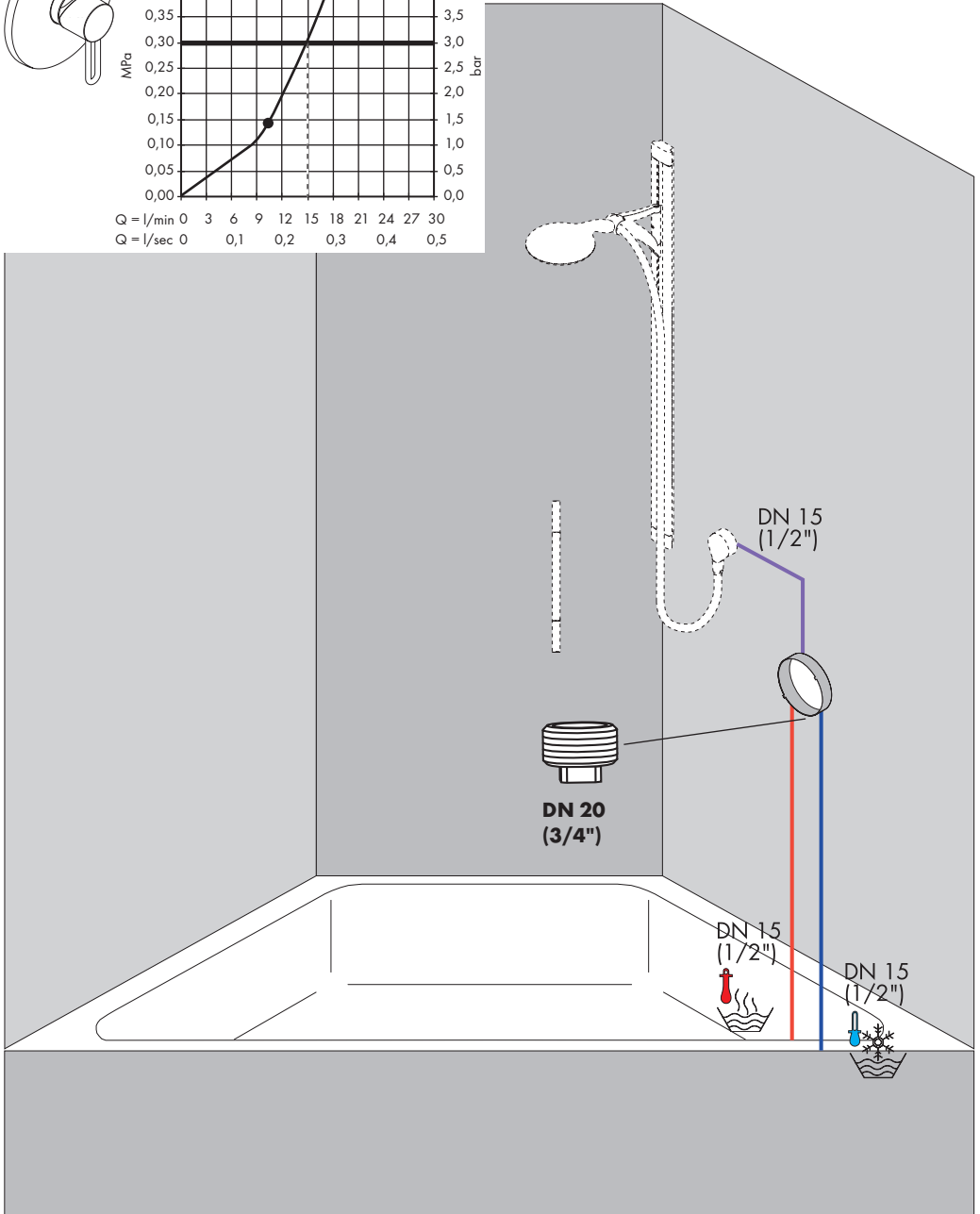
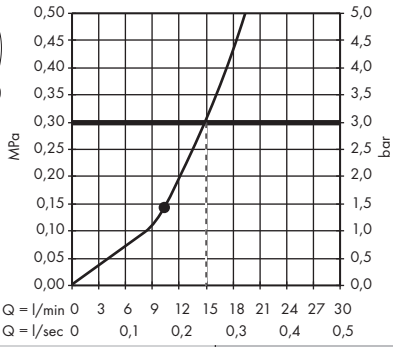
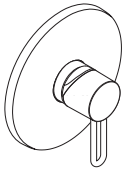

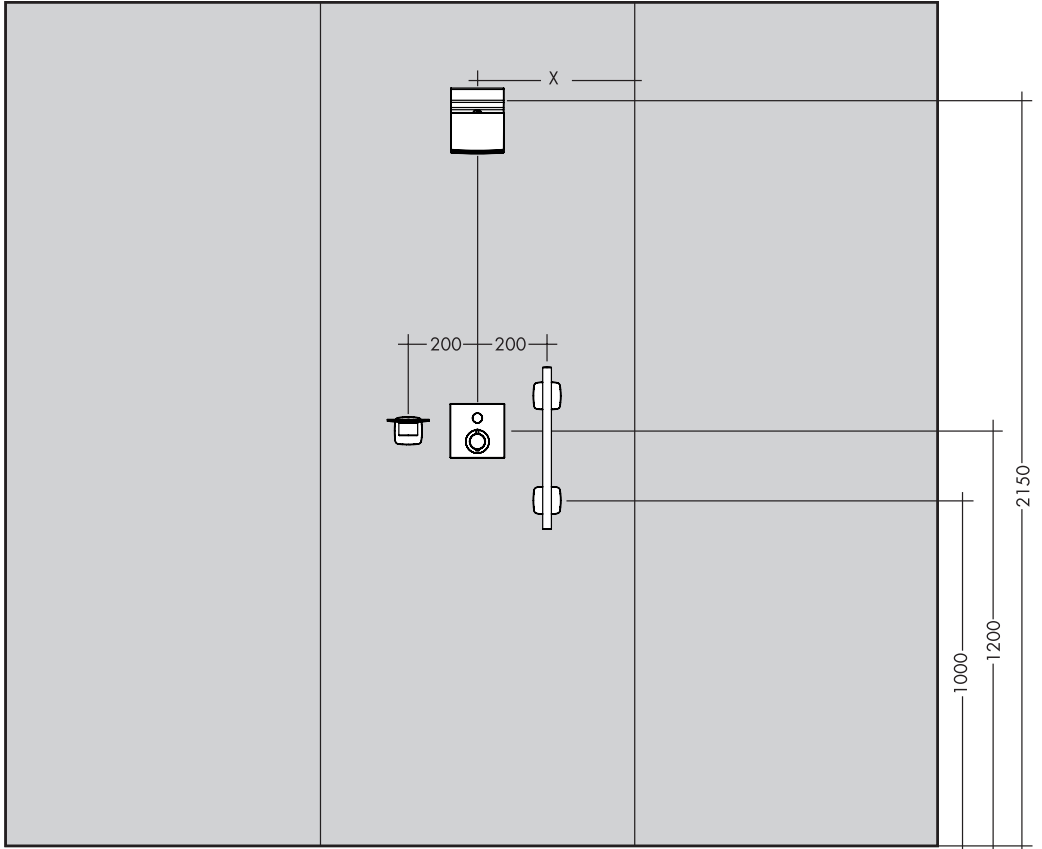
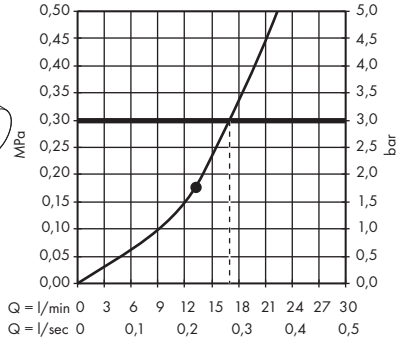
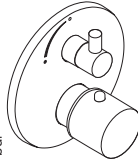
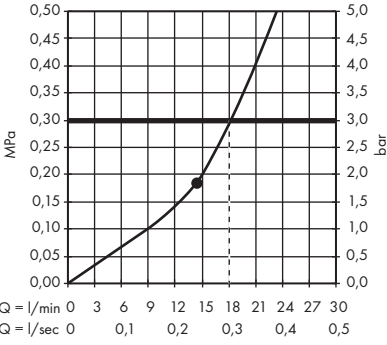
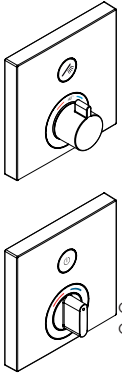

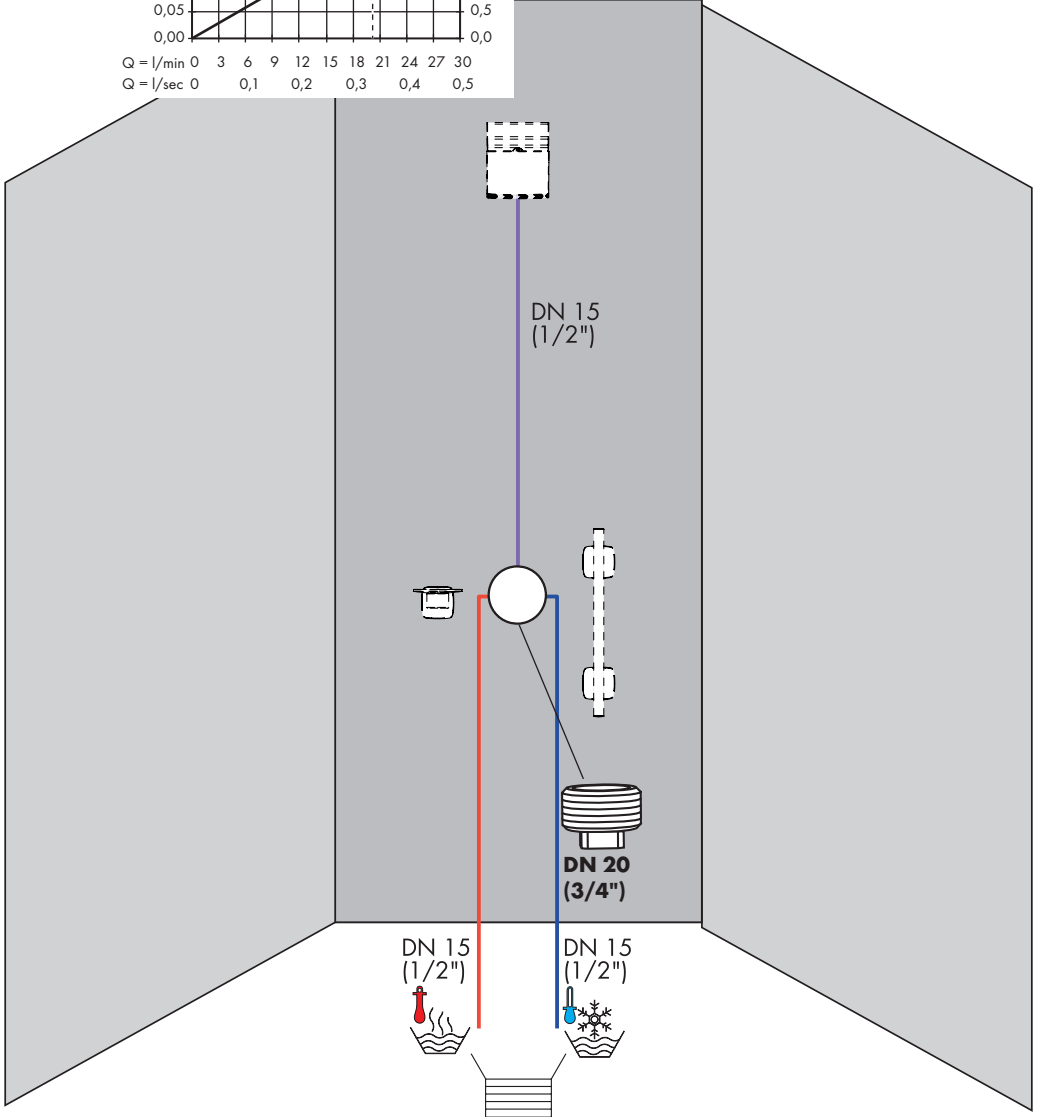
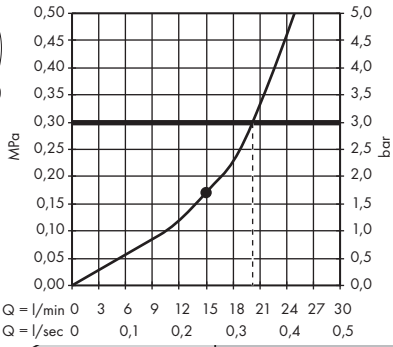
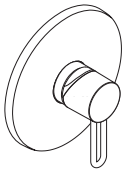

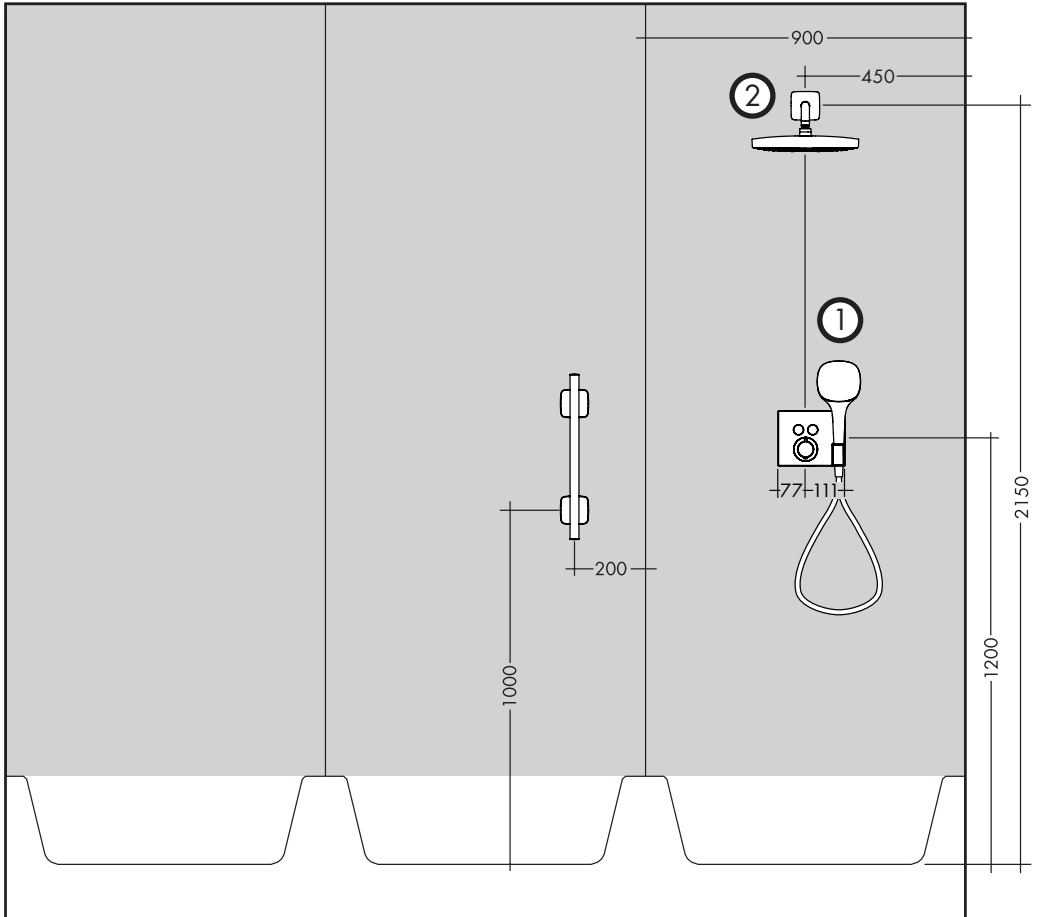
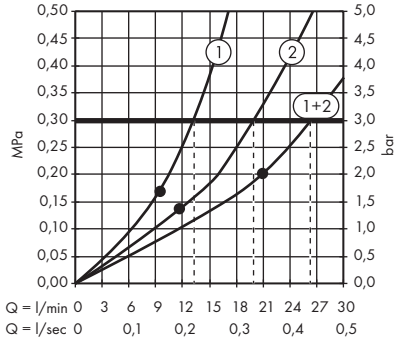
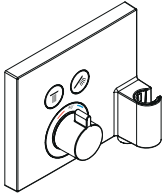

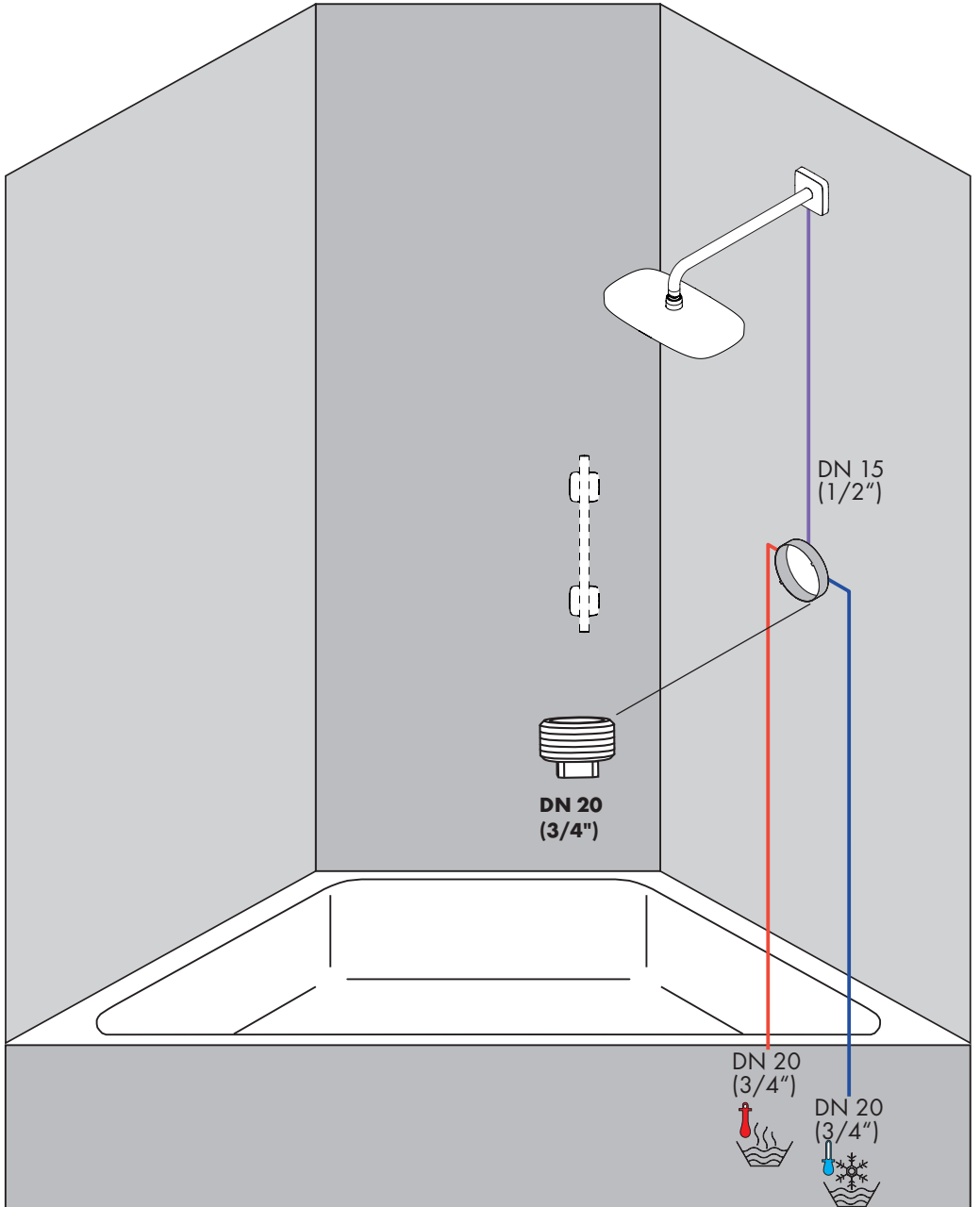

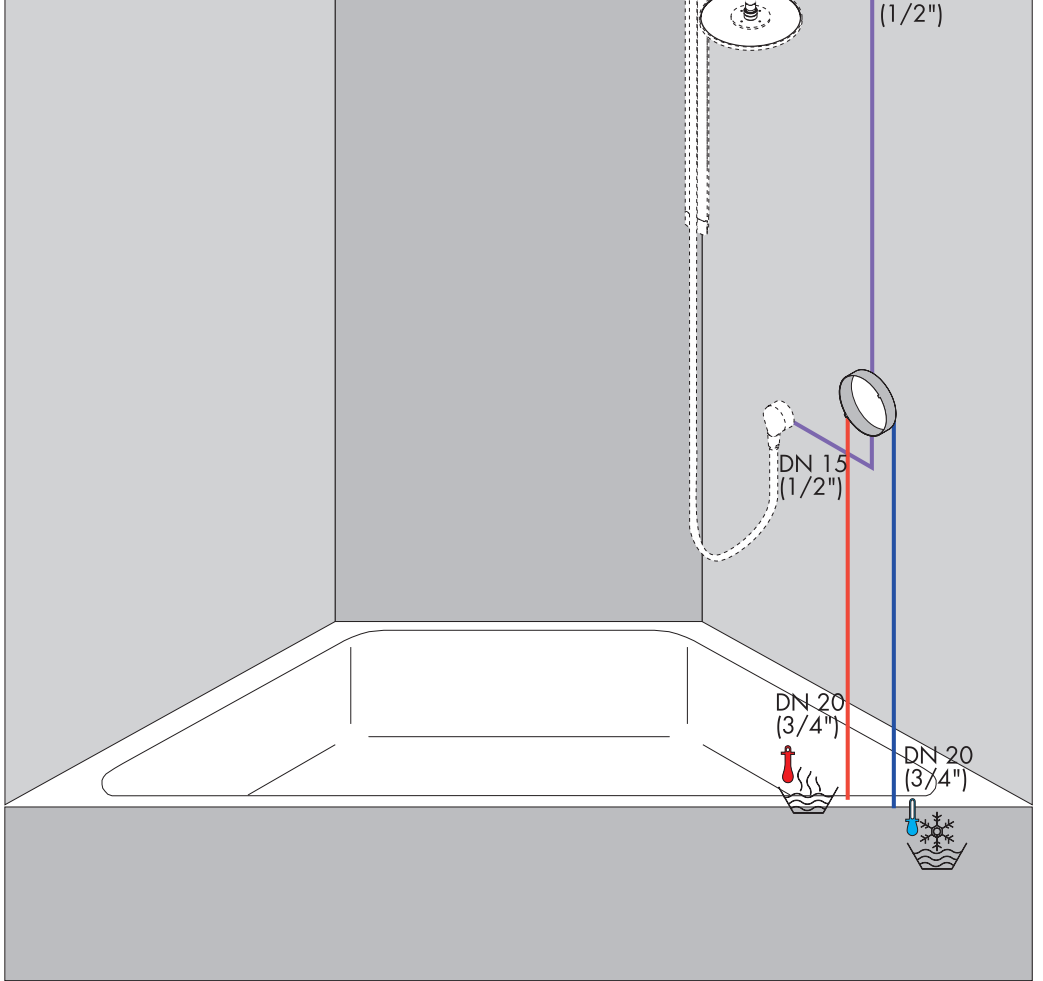
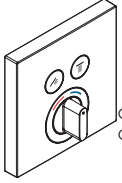
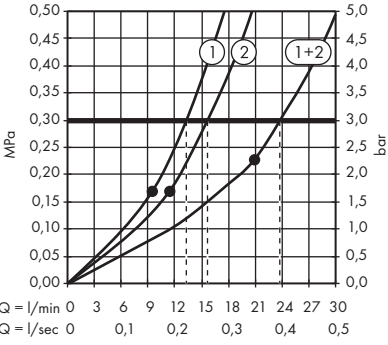
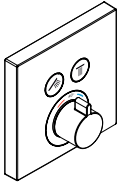

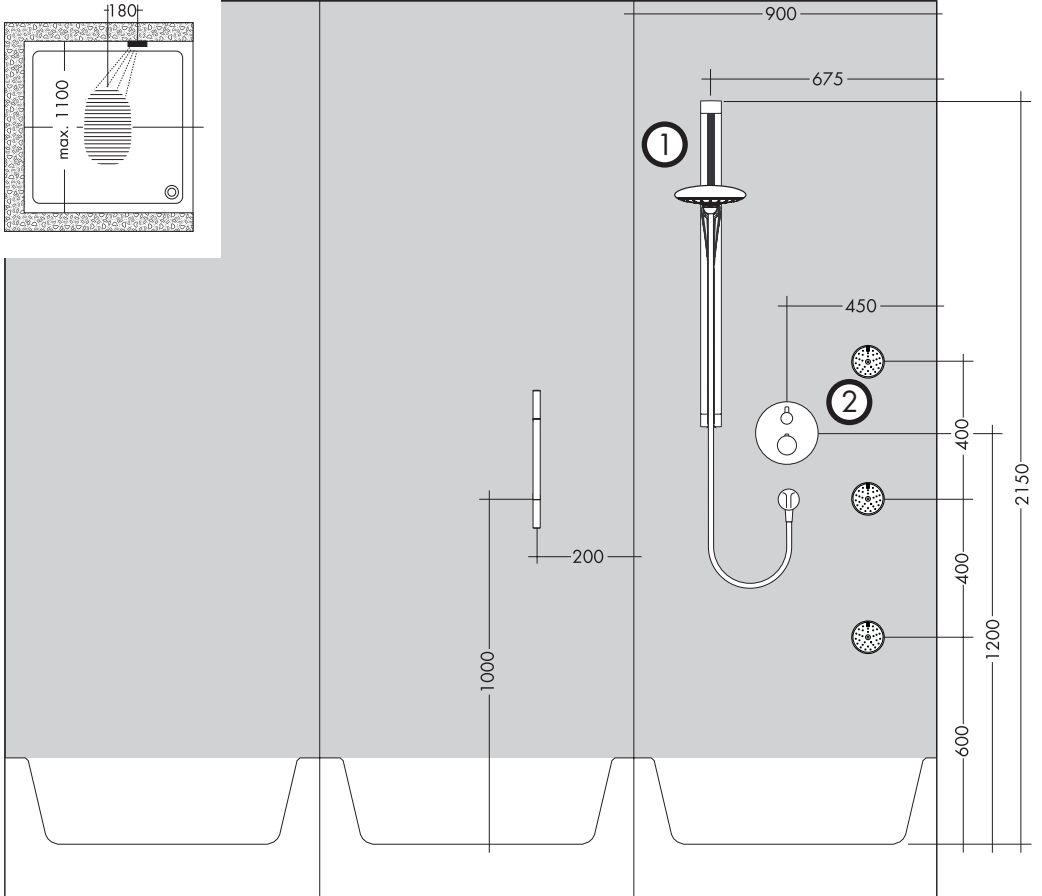
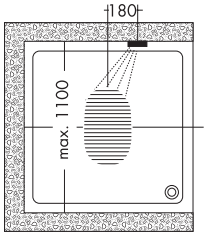
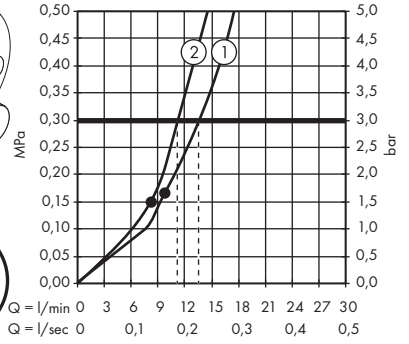
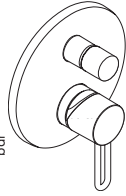
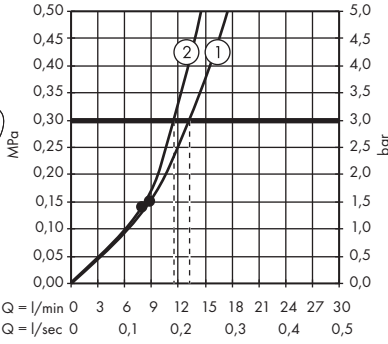
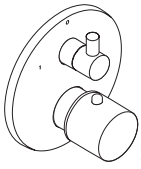

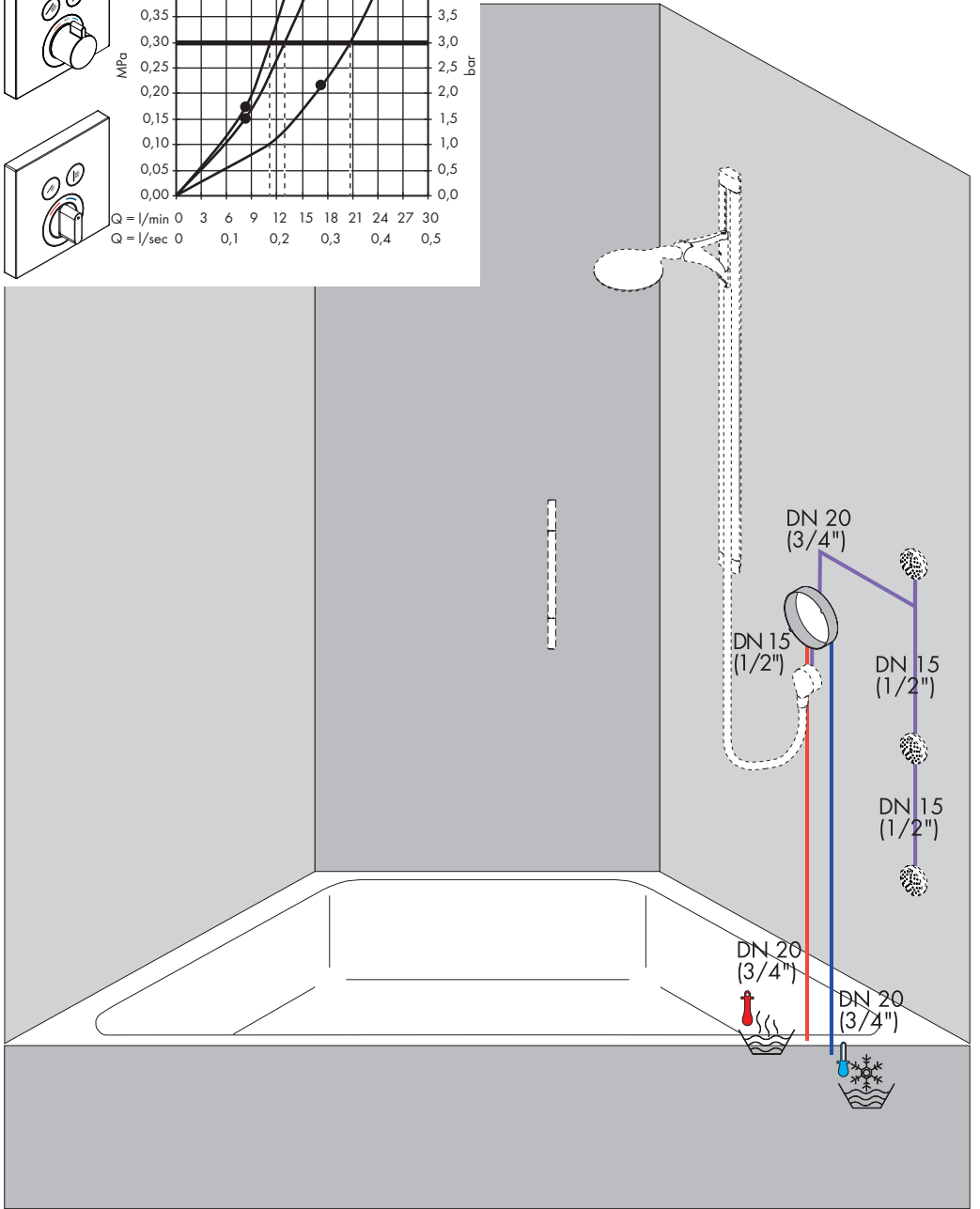
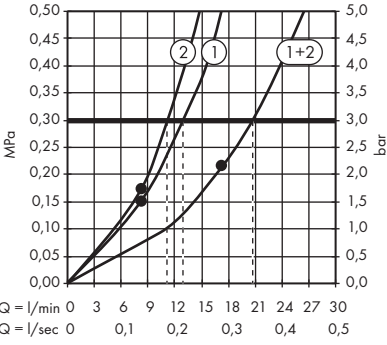
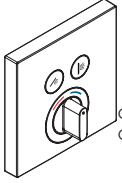
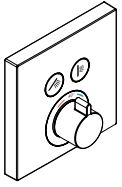

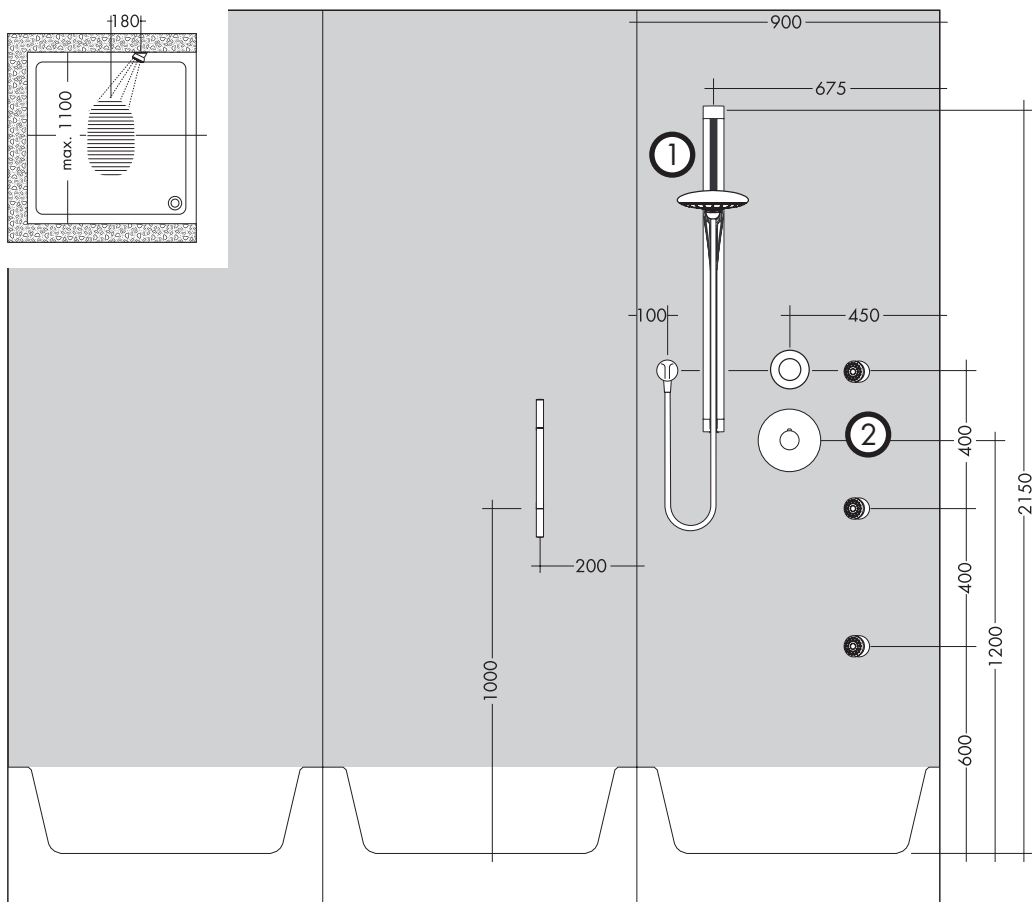
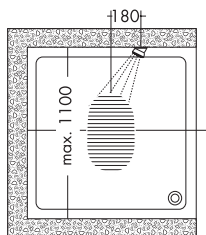
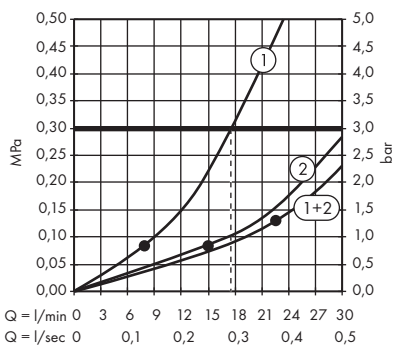
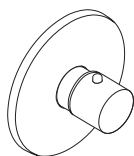

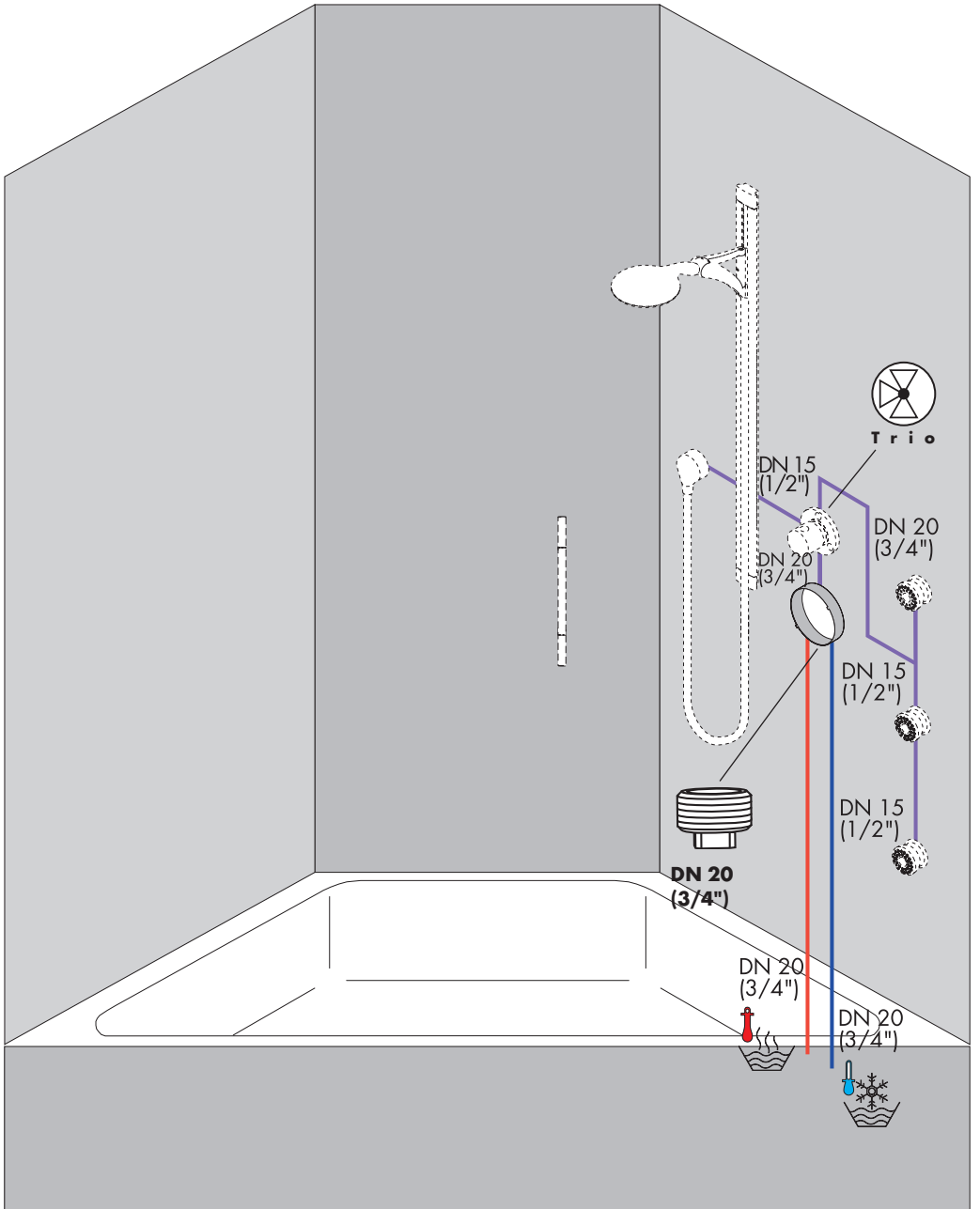

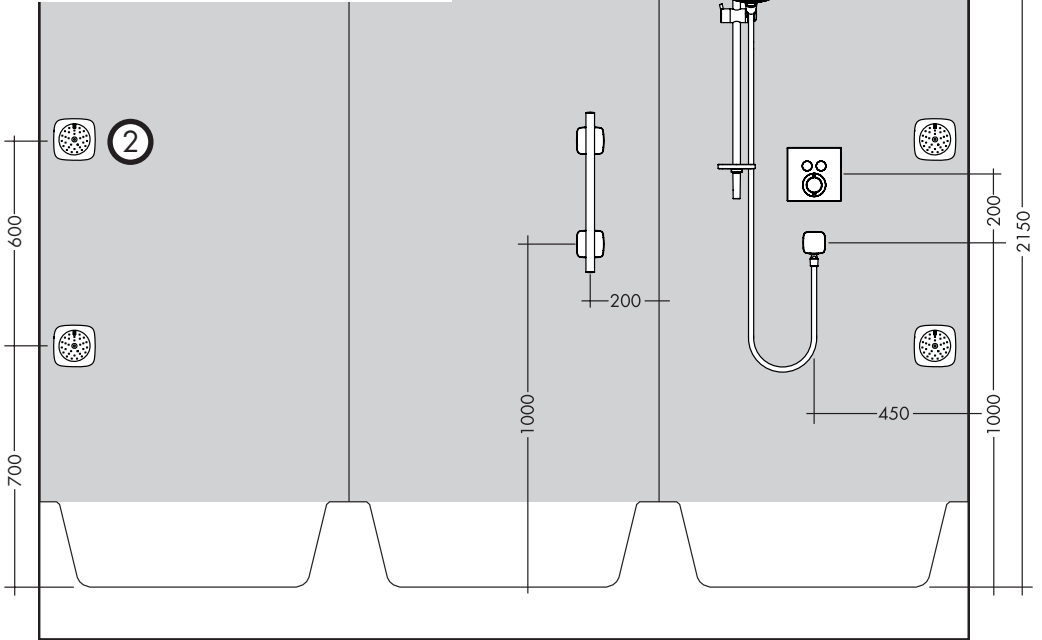
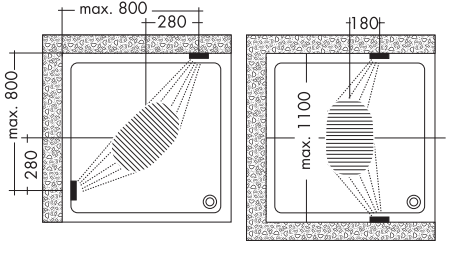
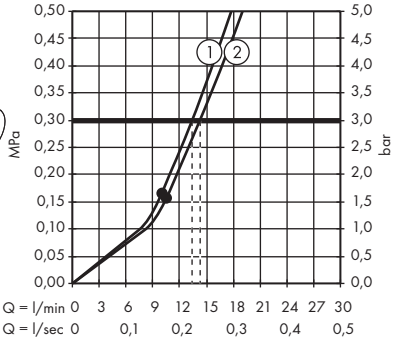
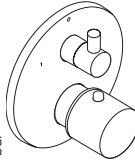
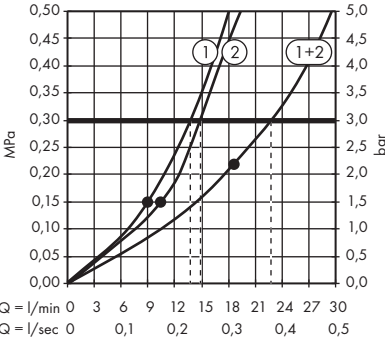
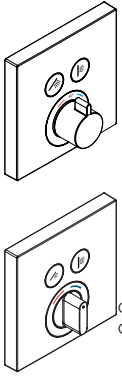

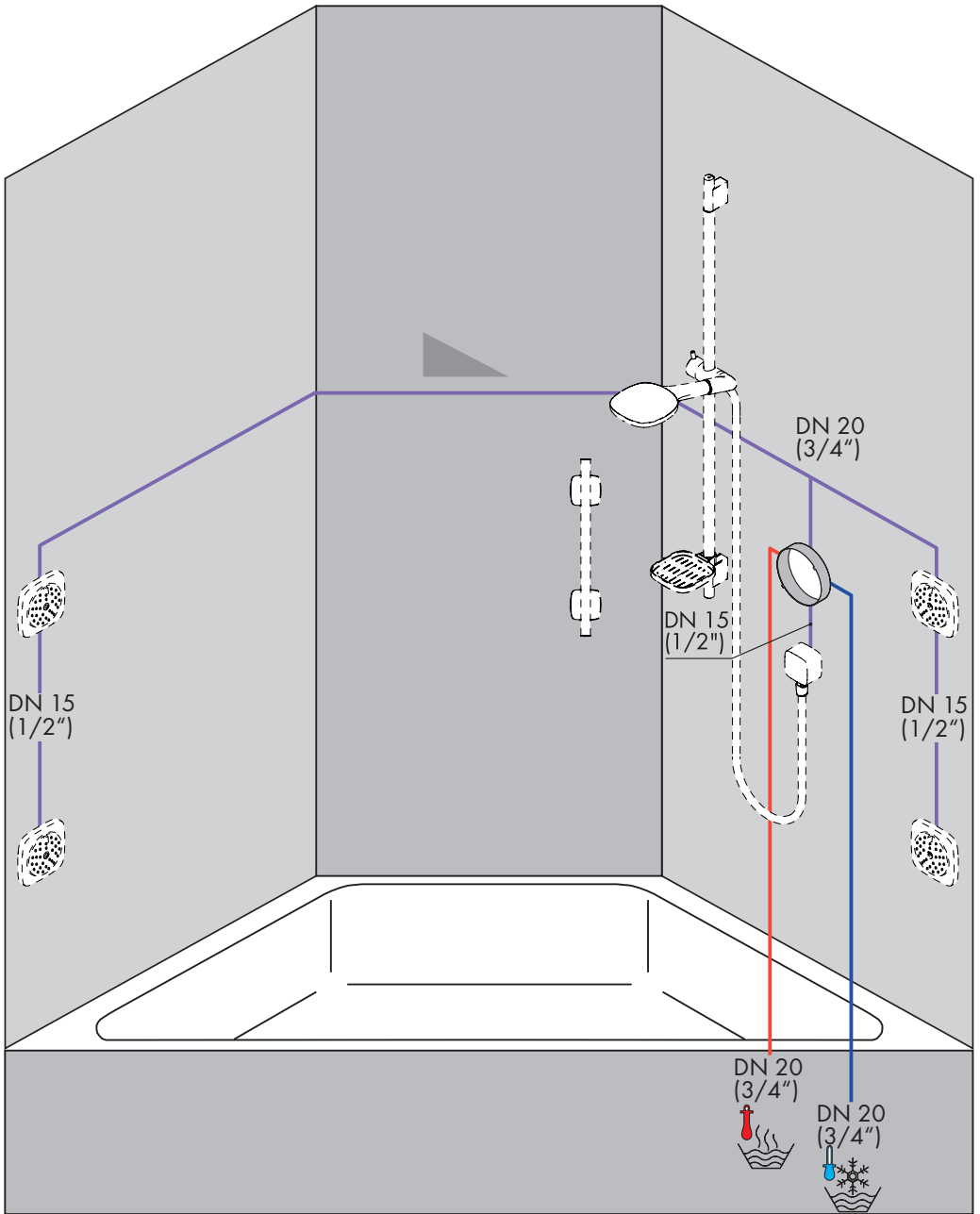

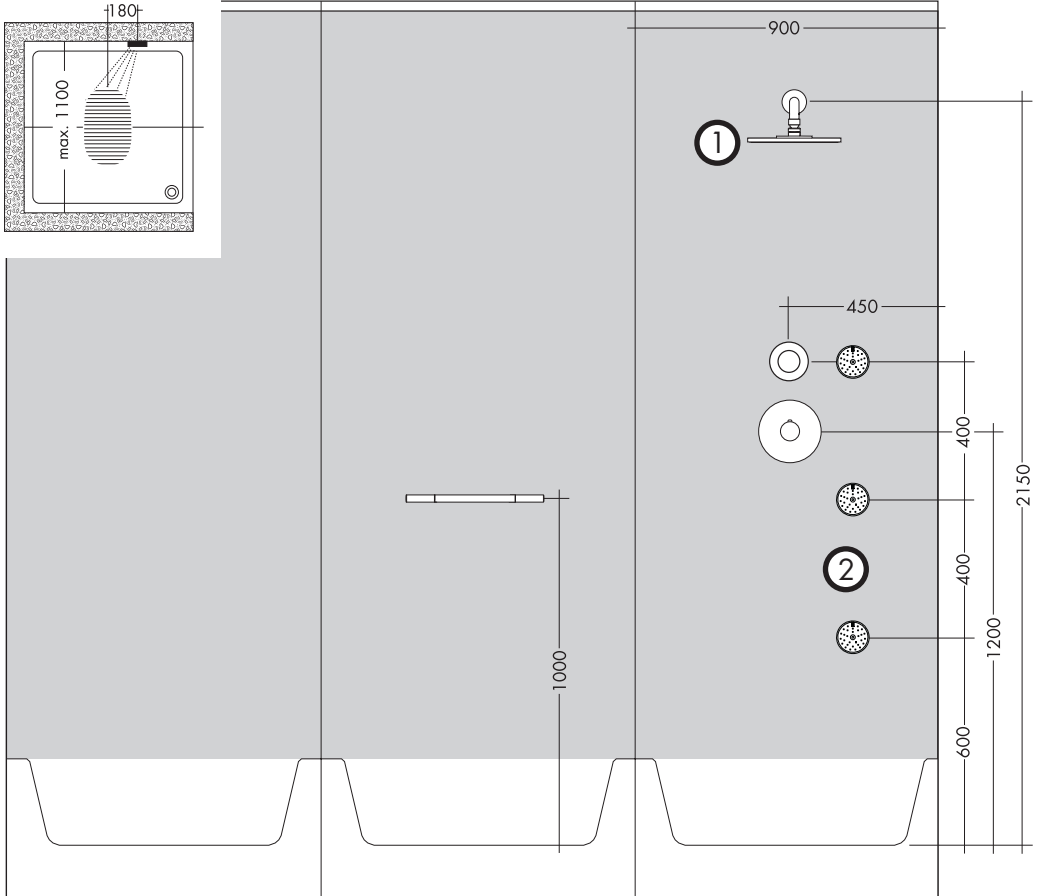
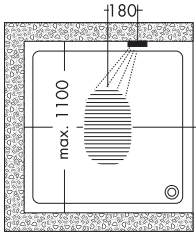
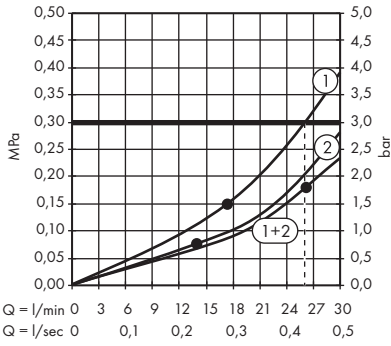
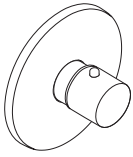

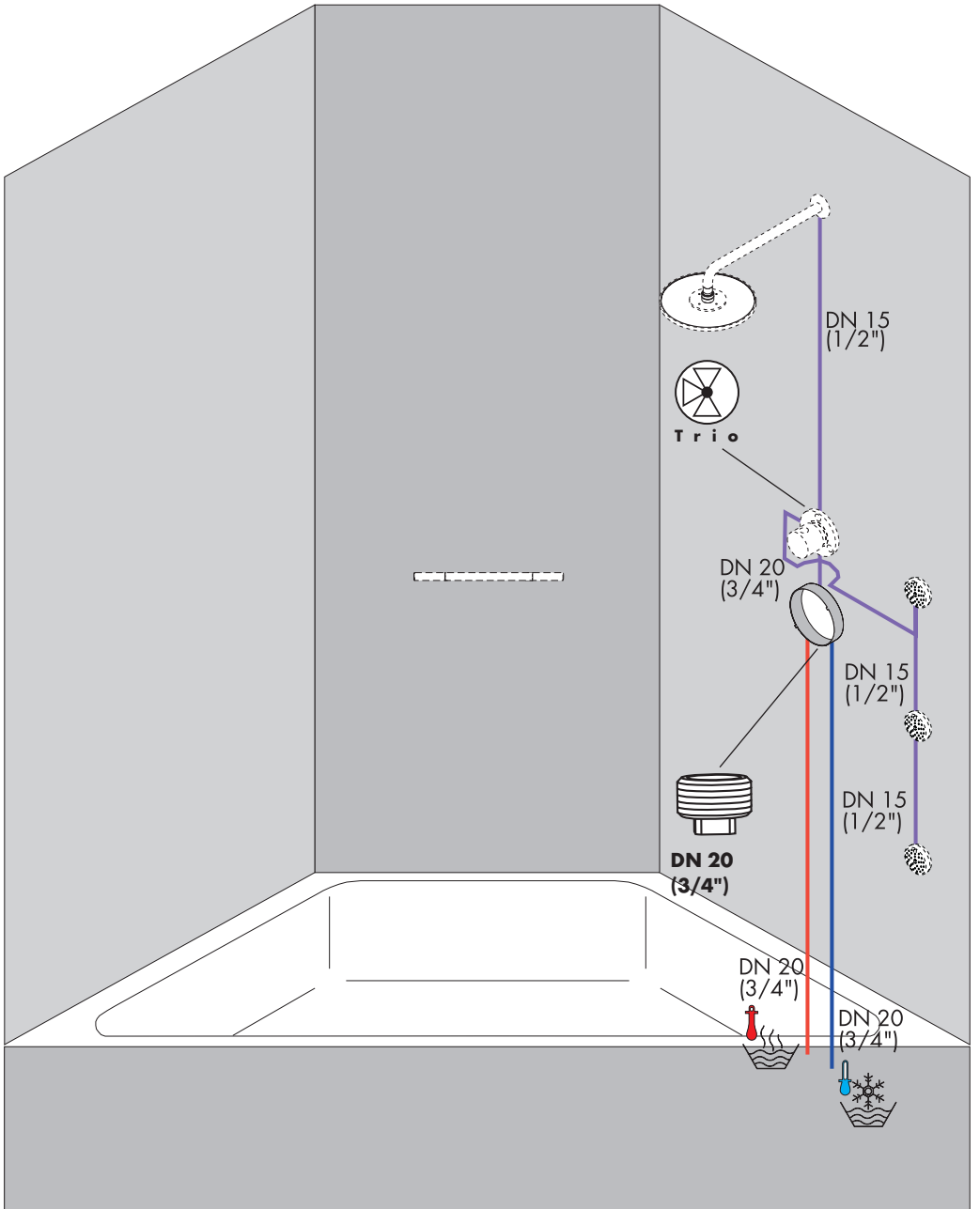

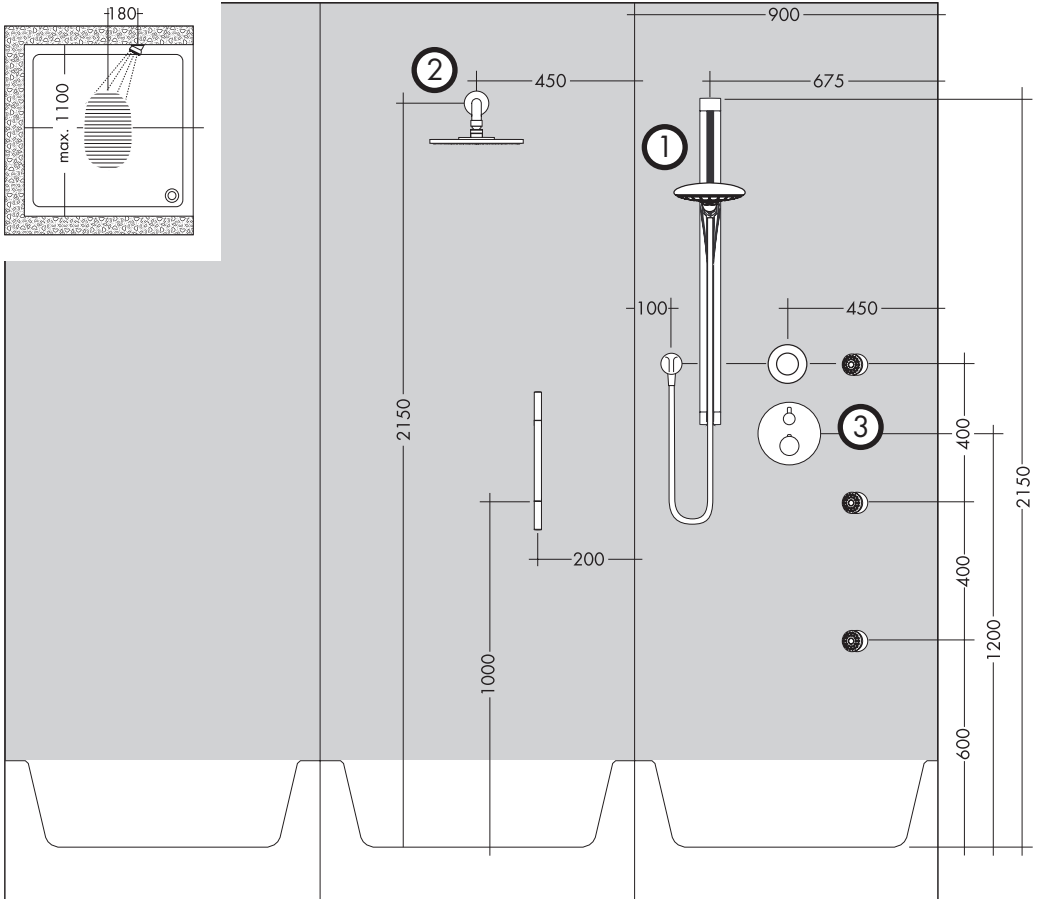
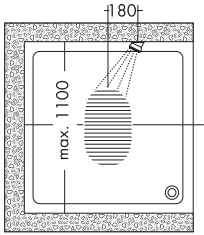
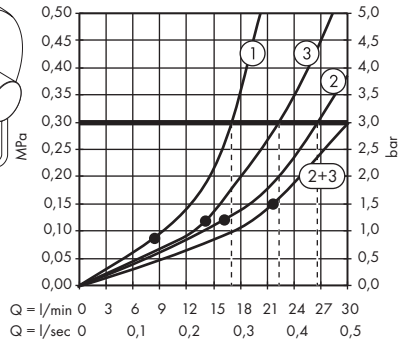
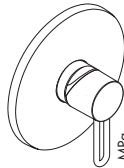
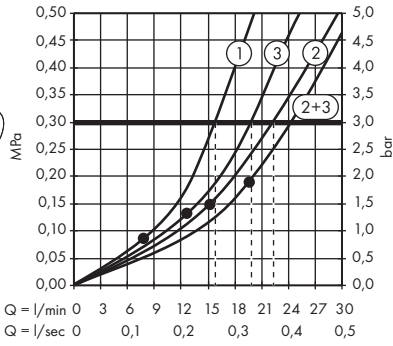
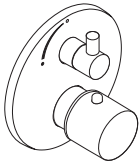

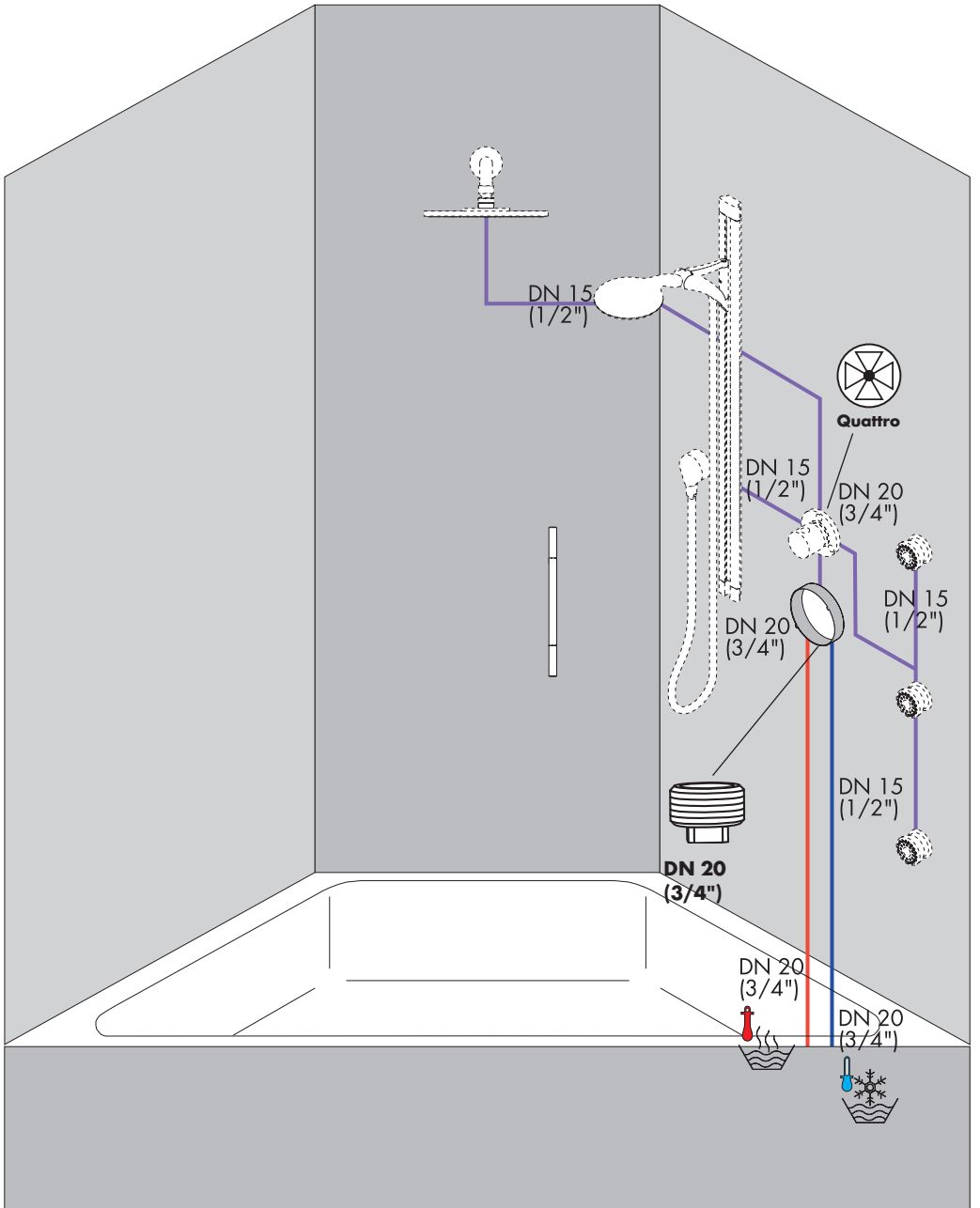

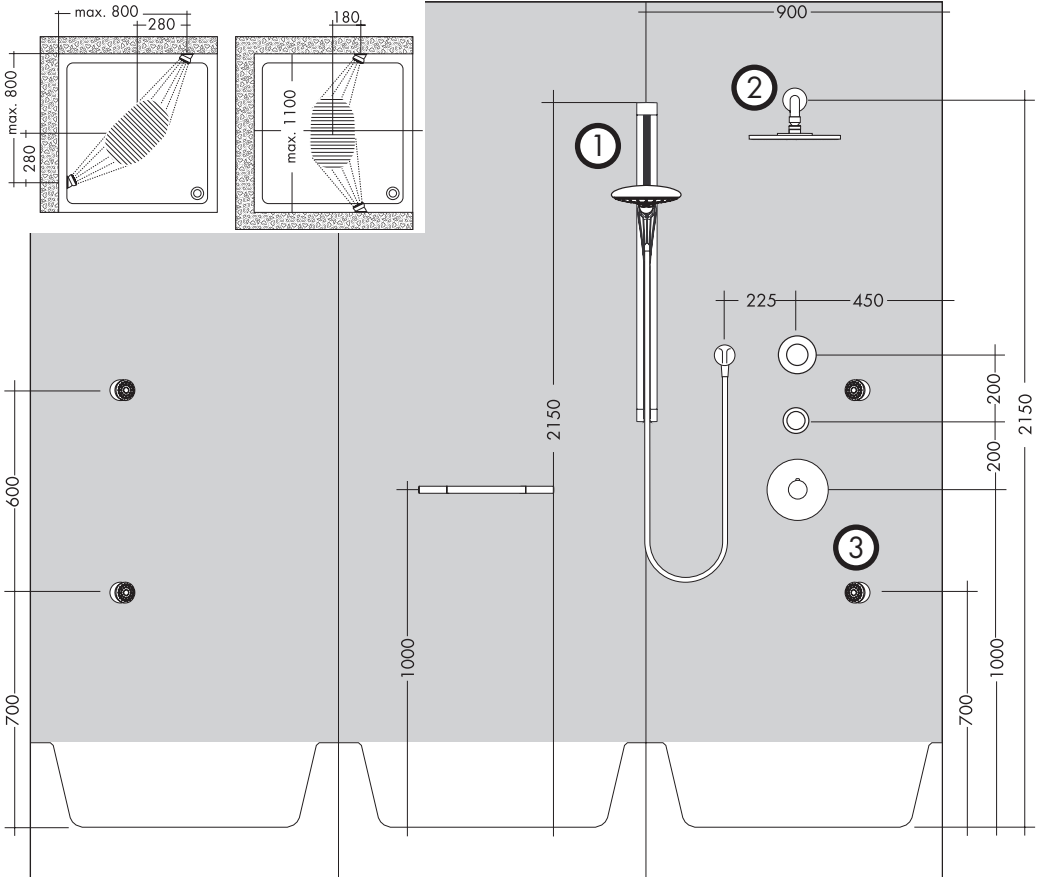
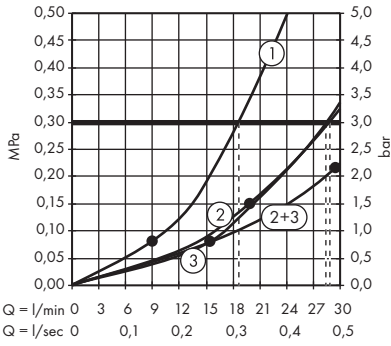
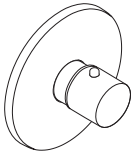

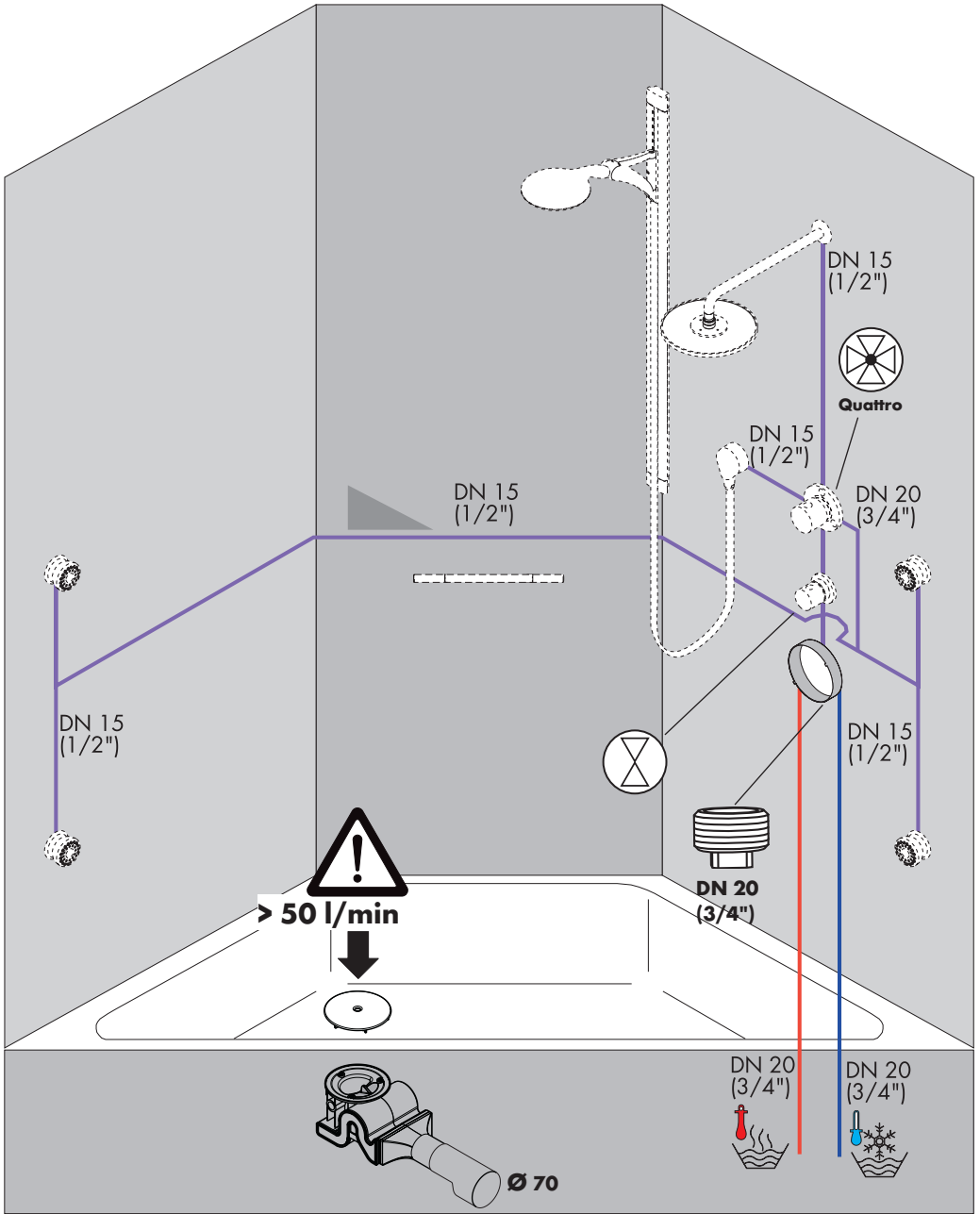

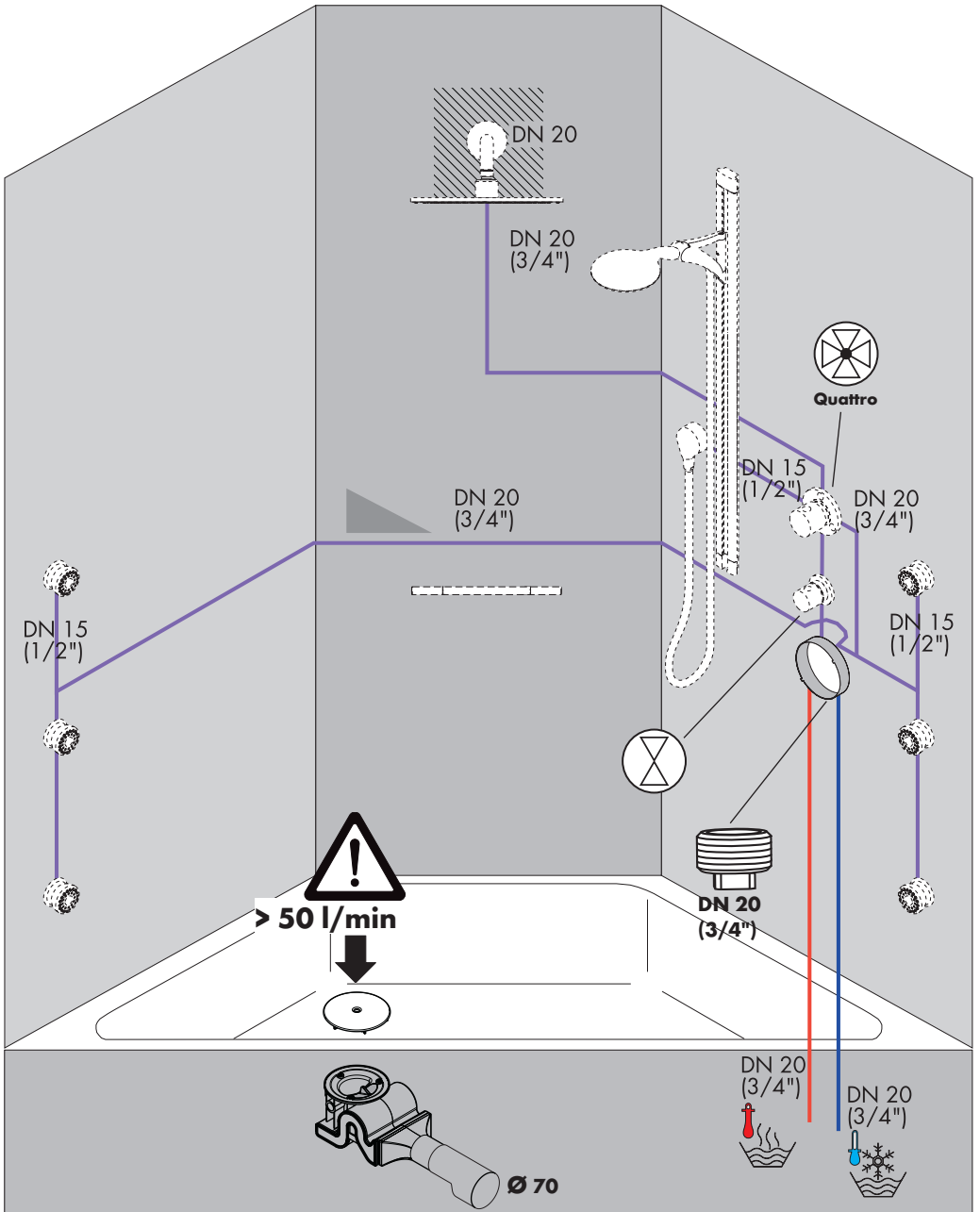

High Flow

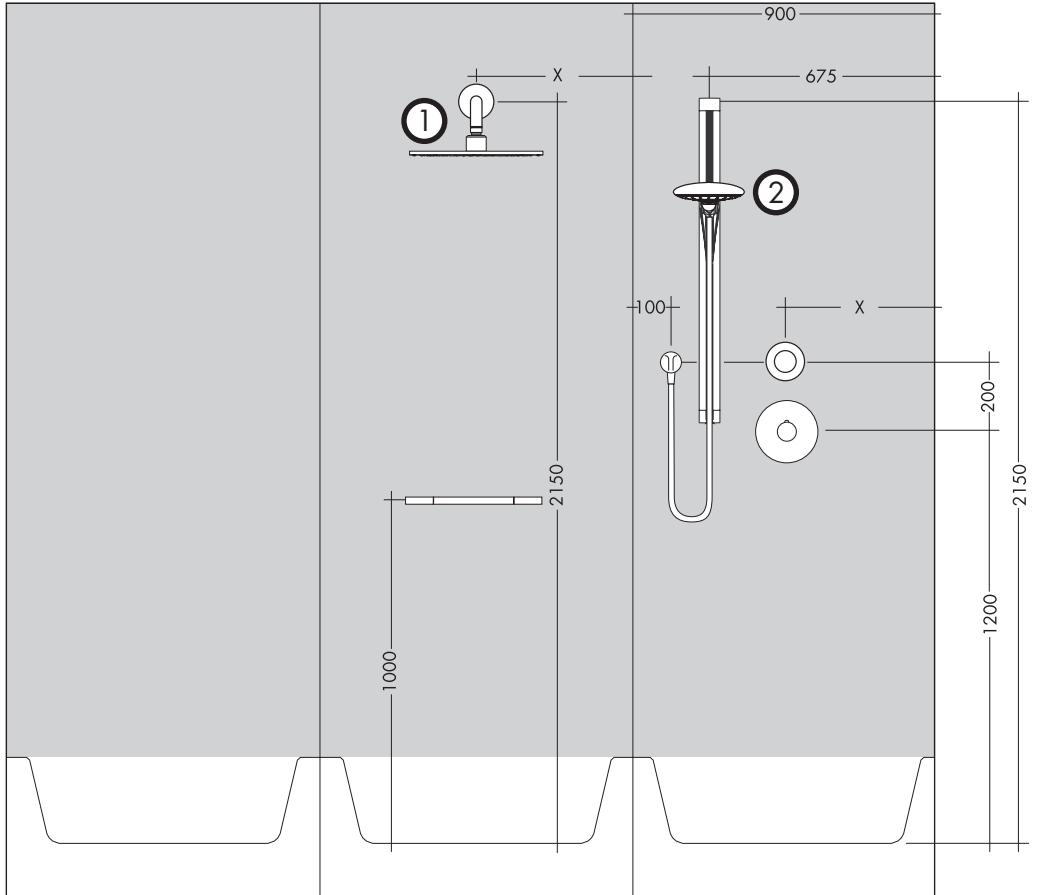
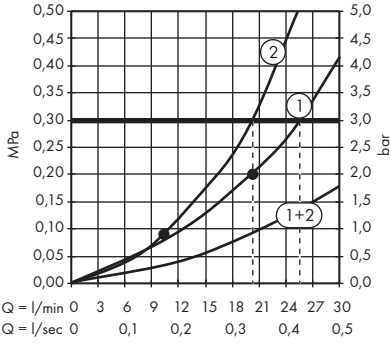
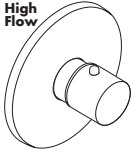

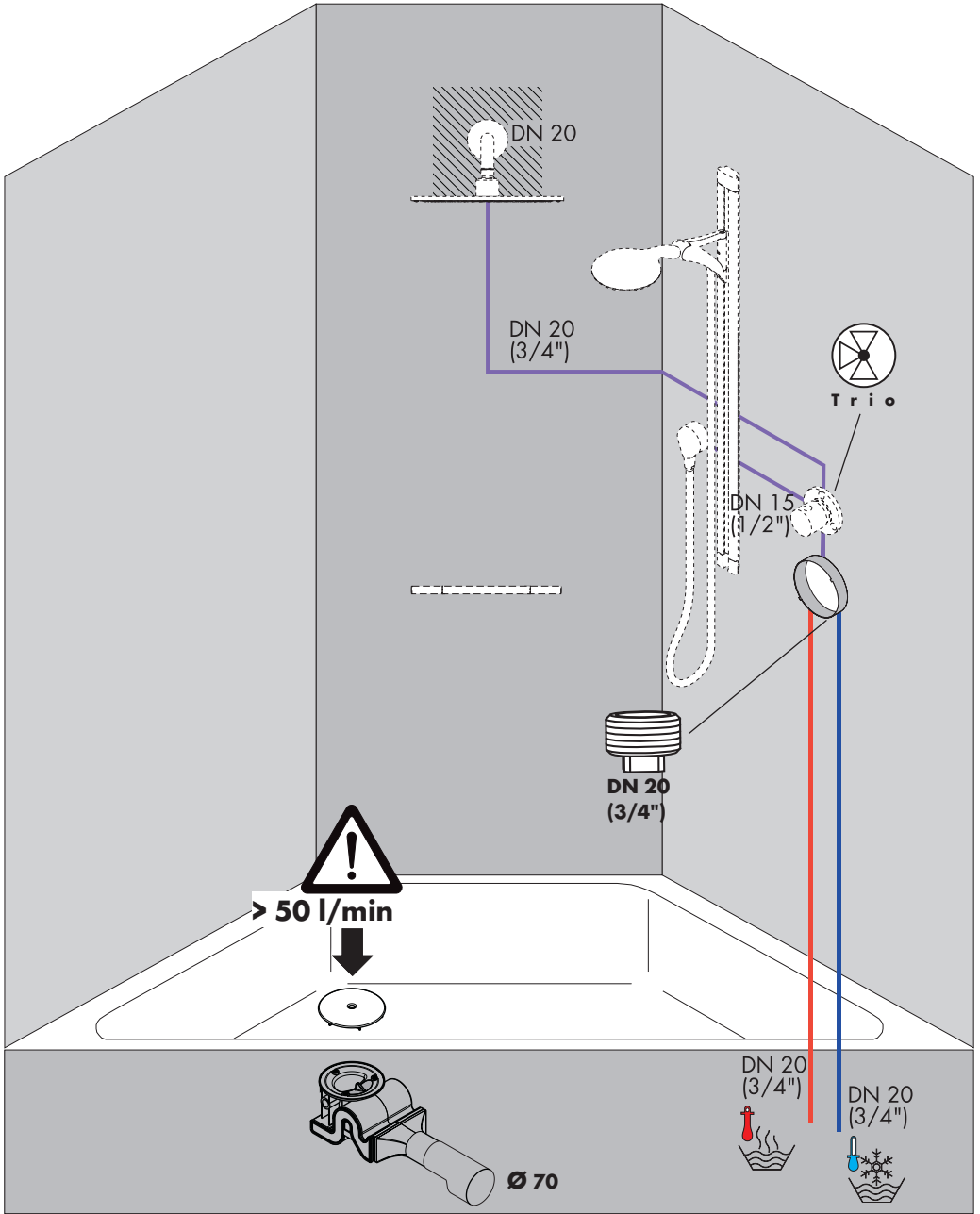

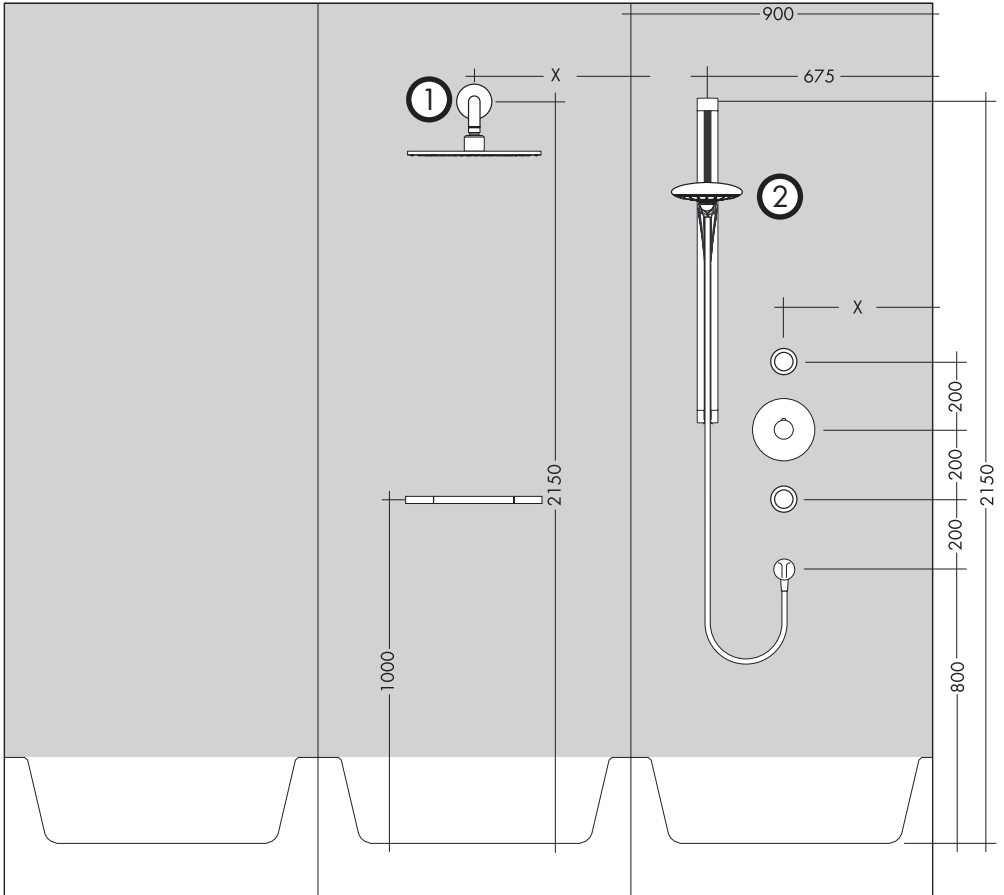
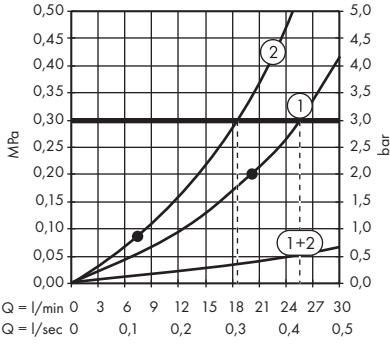
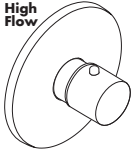

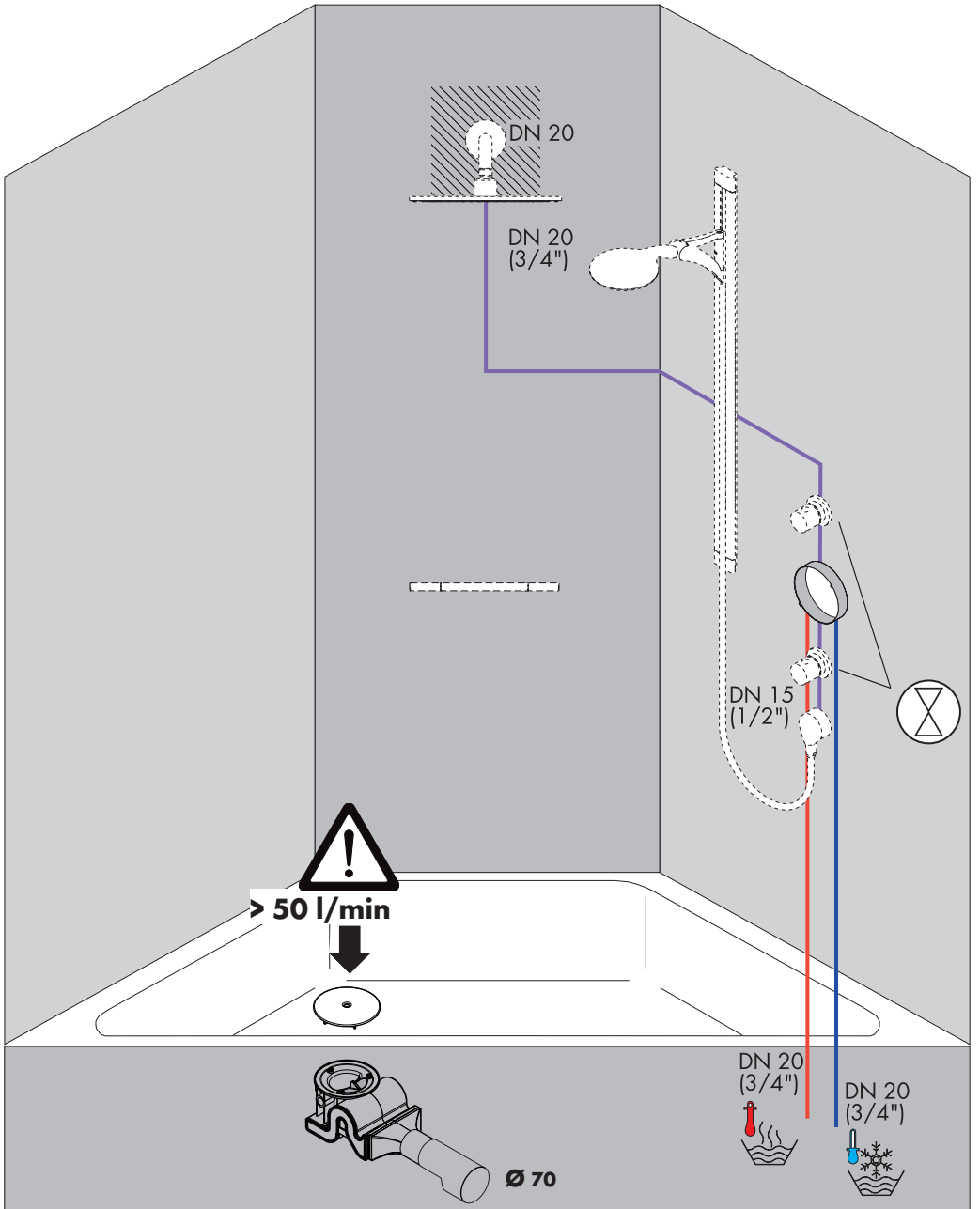

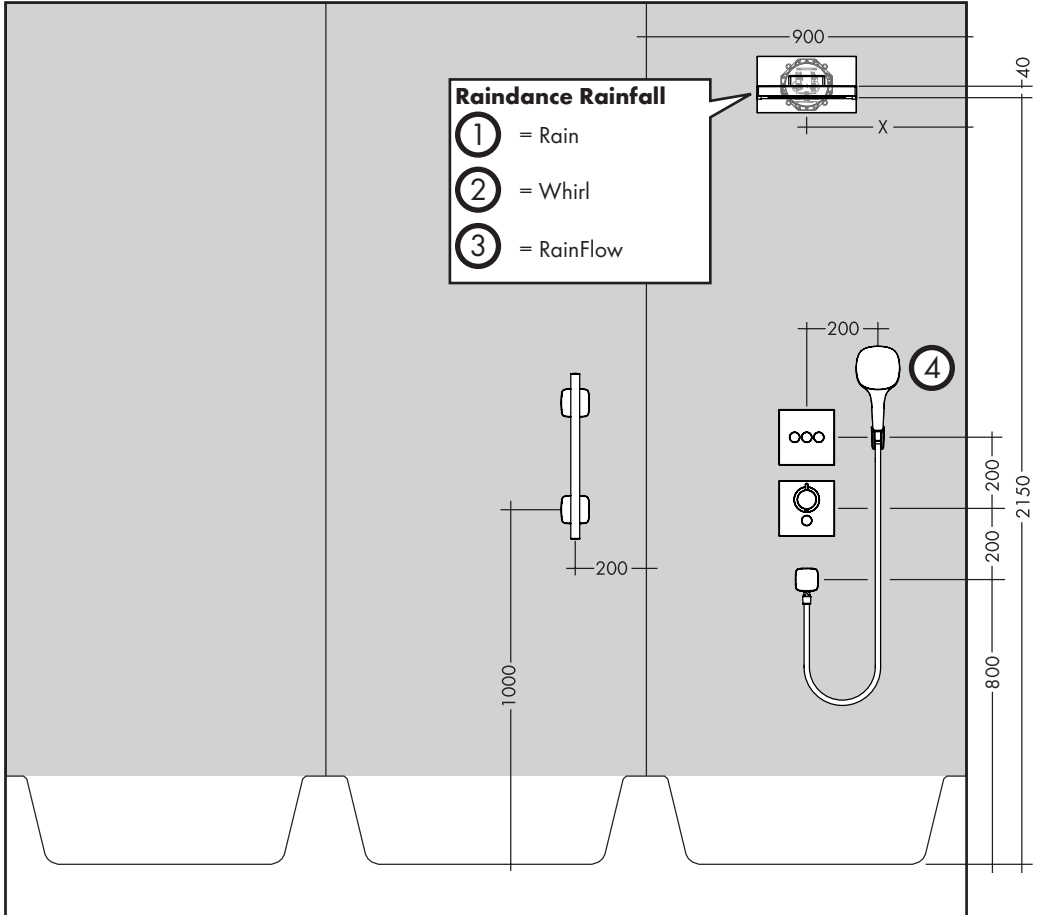
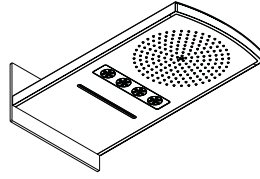
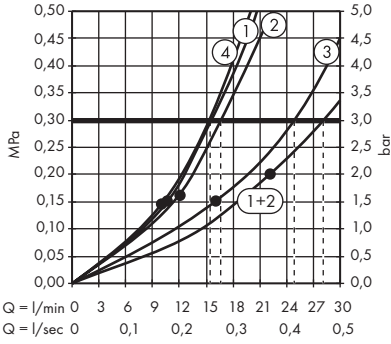
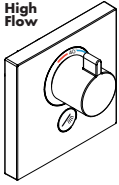
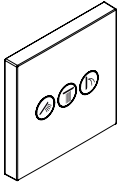

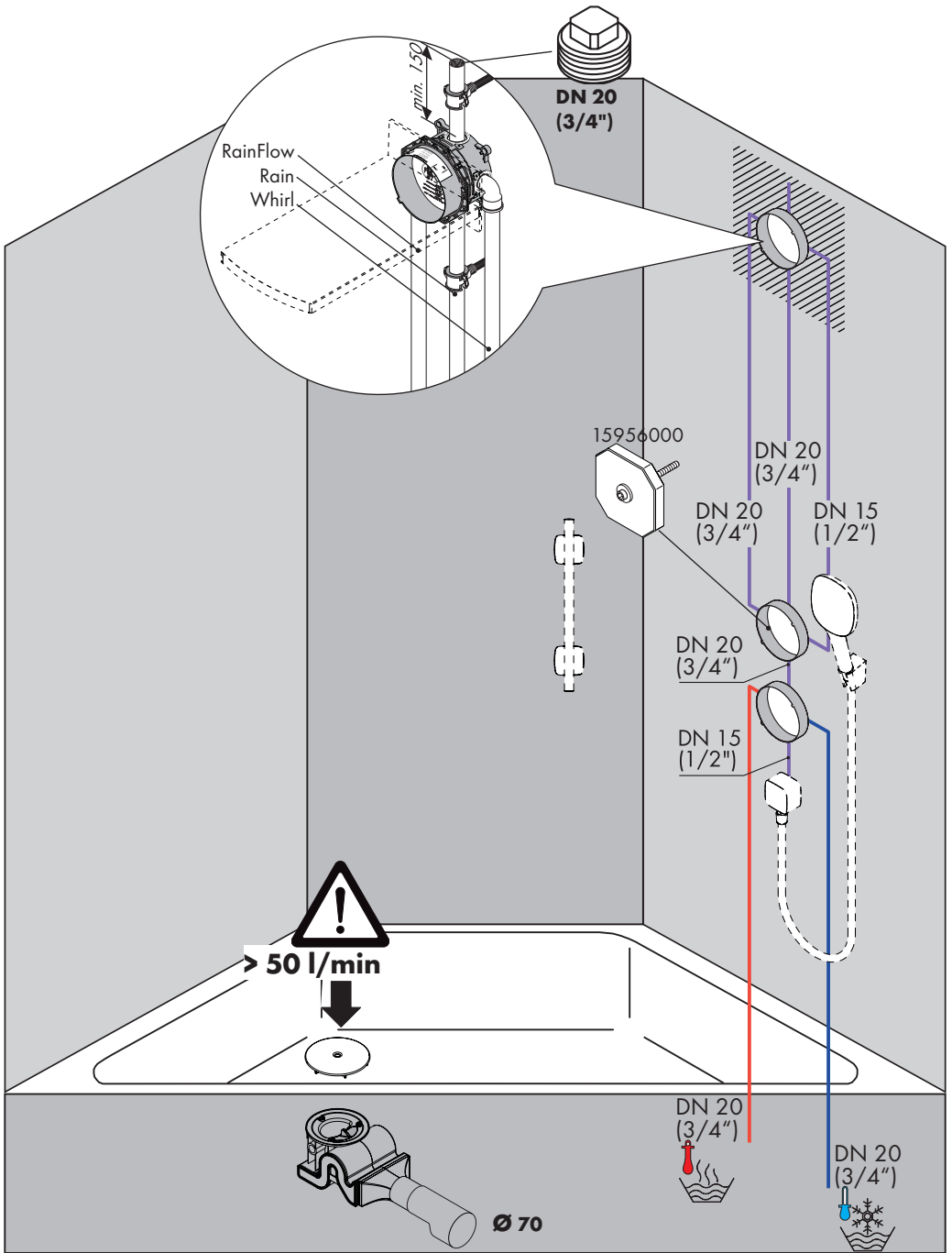

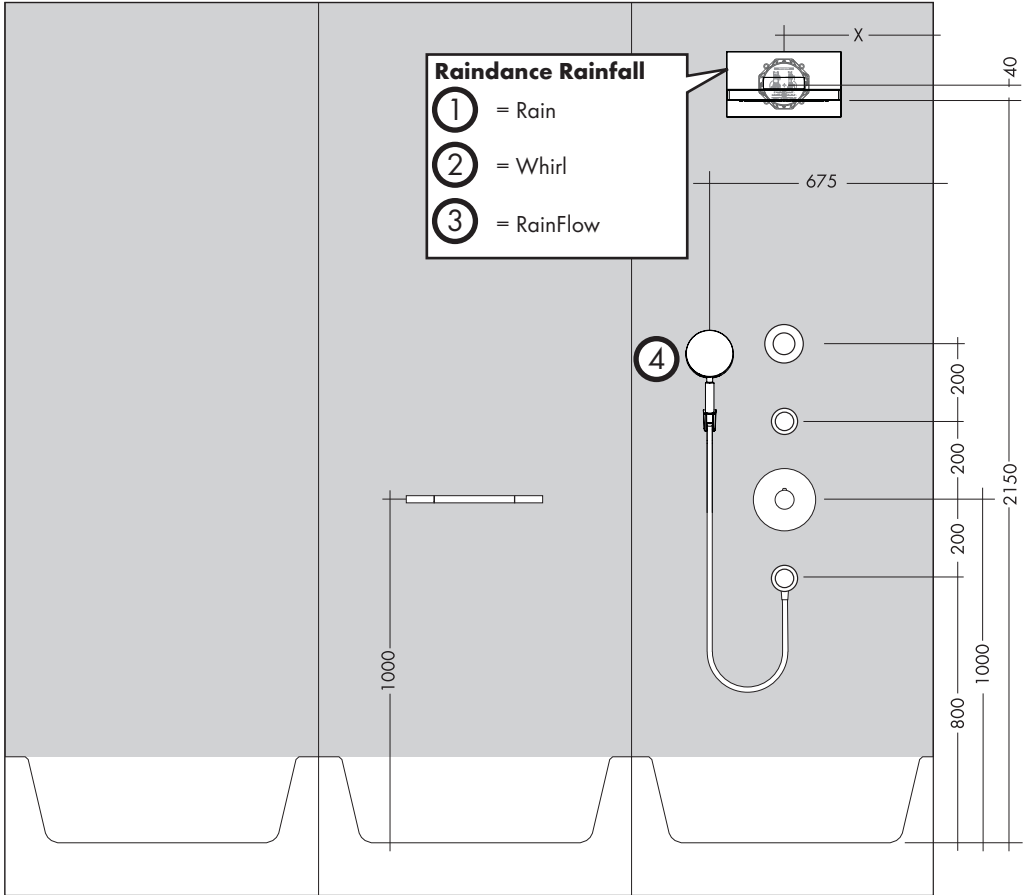
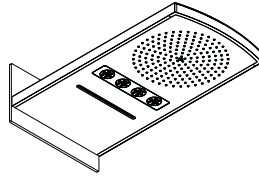
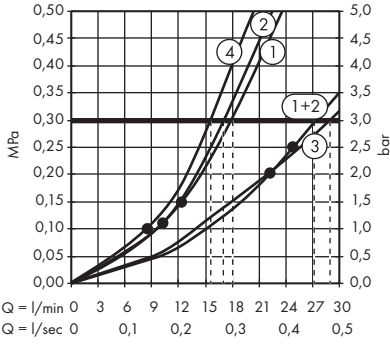
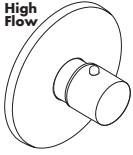

High Flow

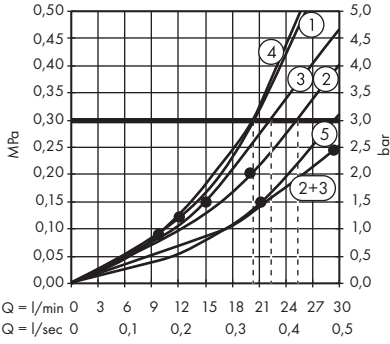
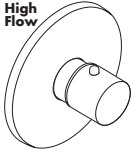

Raindance Rainmaker

- ① = Rain AIR
- ② = Rain AIR XXL
- ③ = Whirl AIR

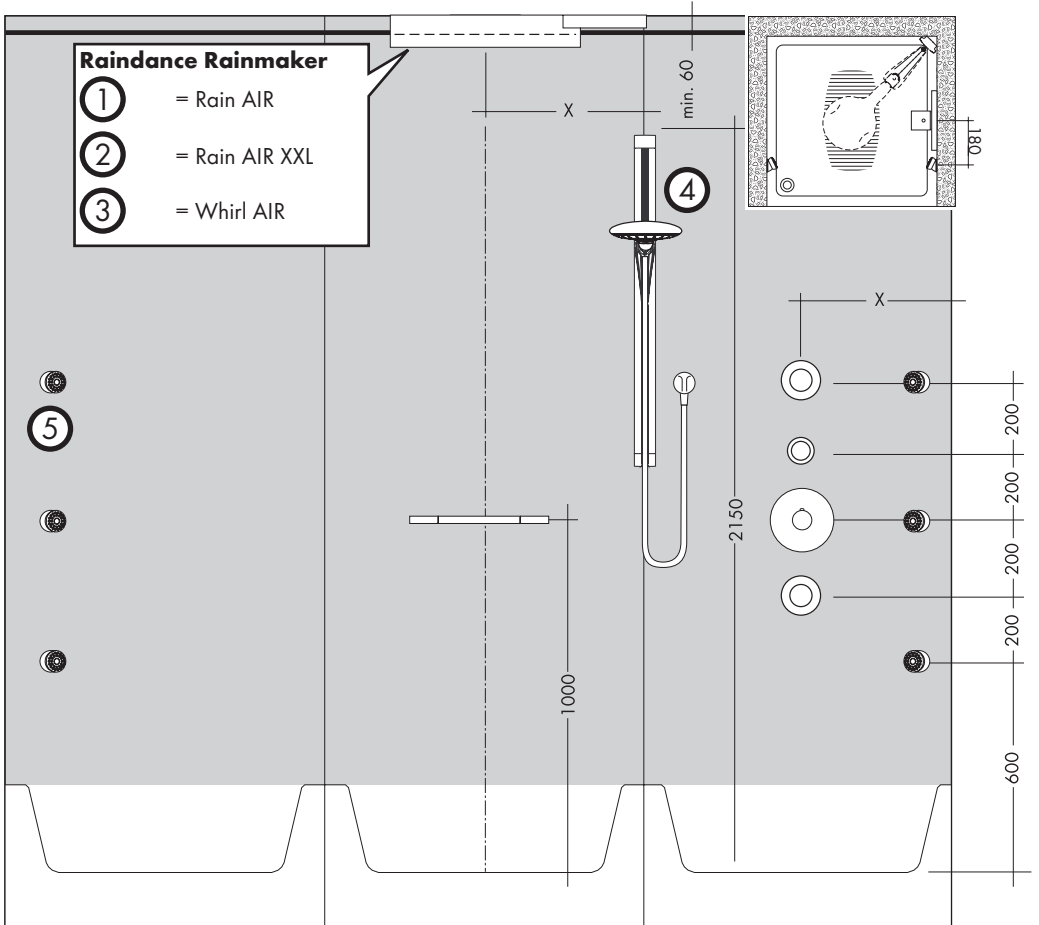

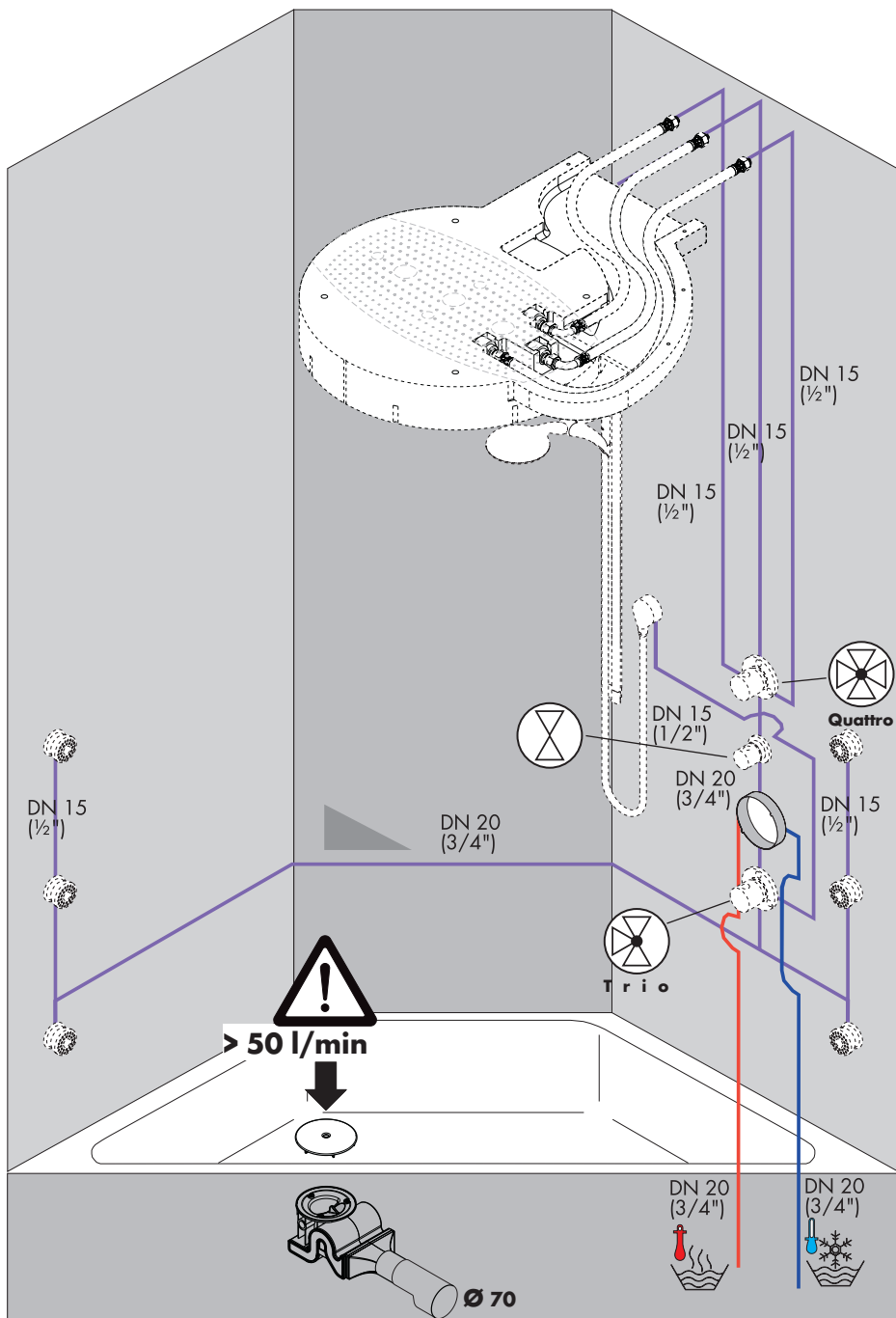

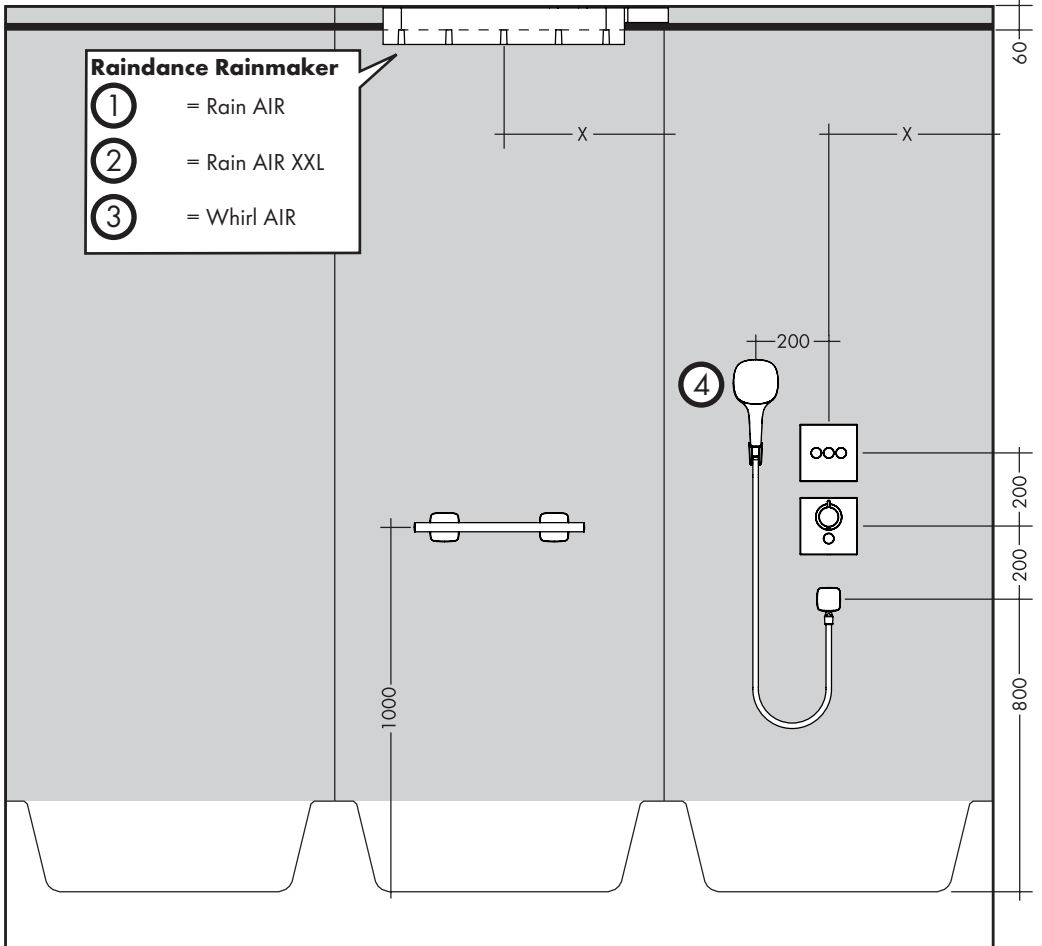
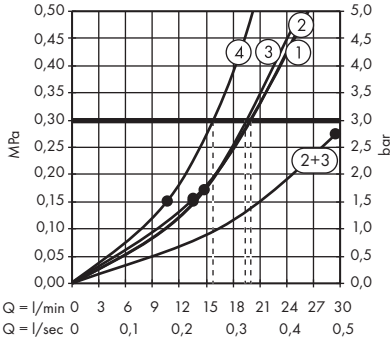
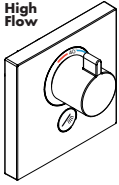
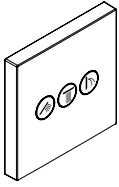

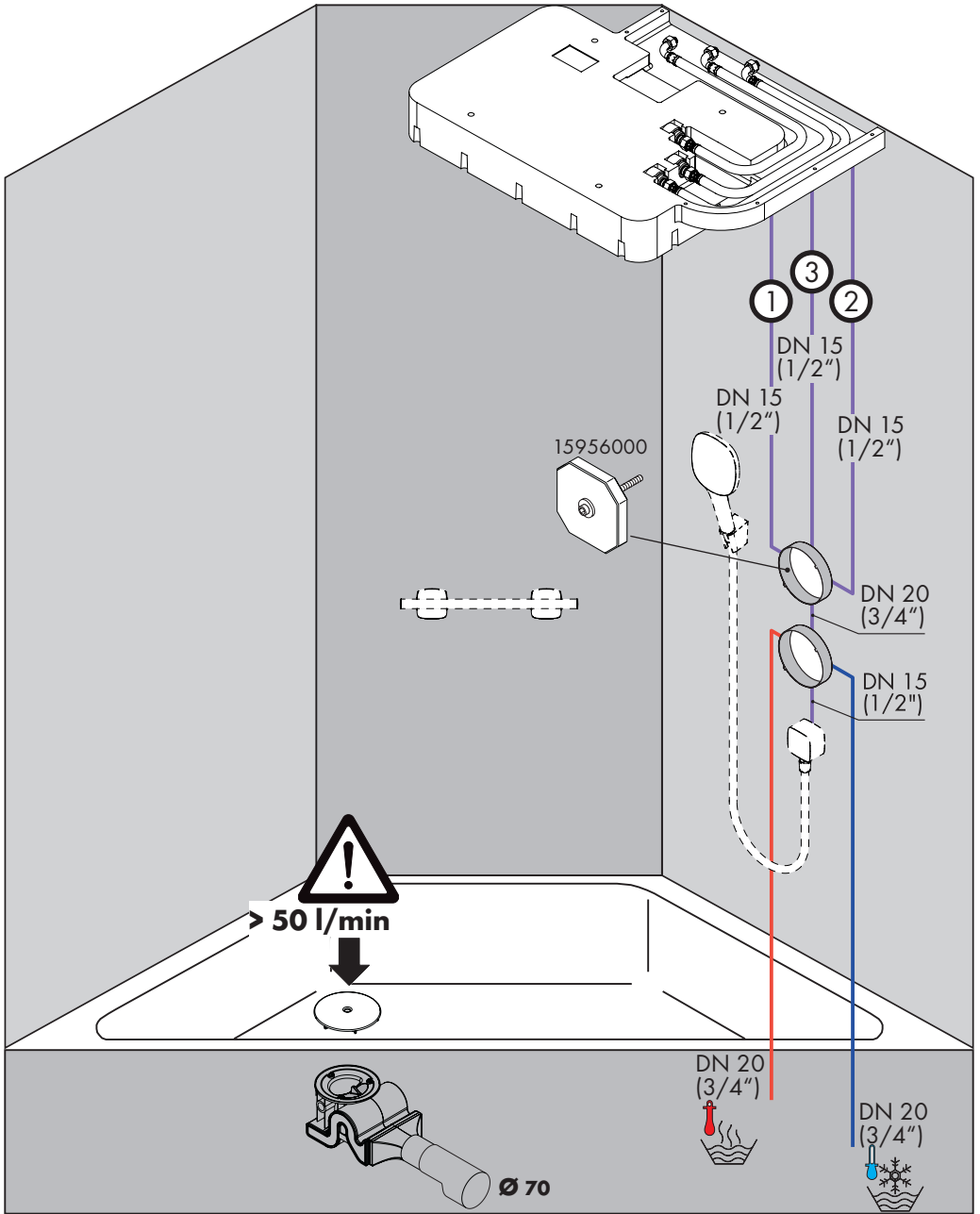

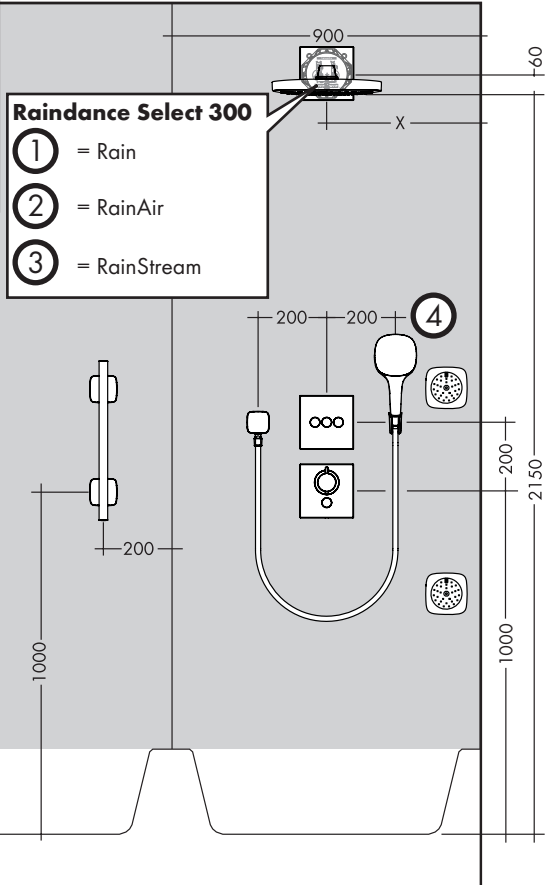
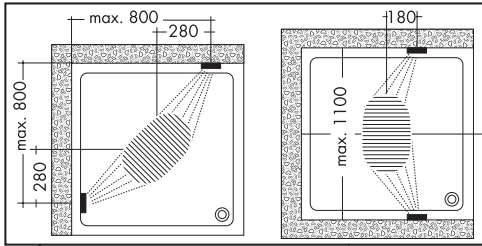
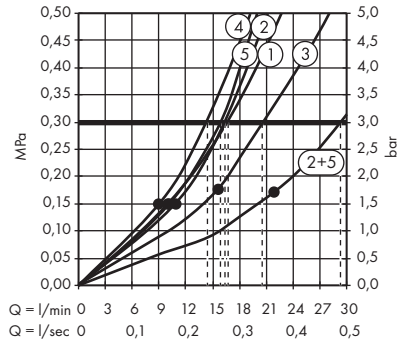
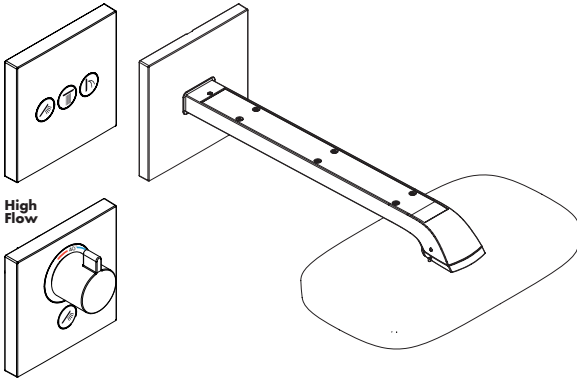

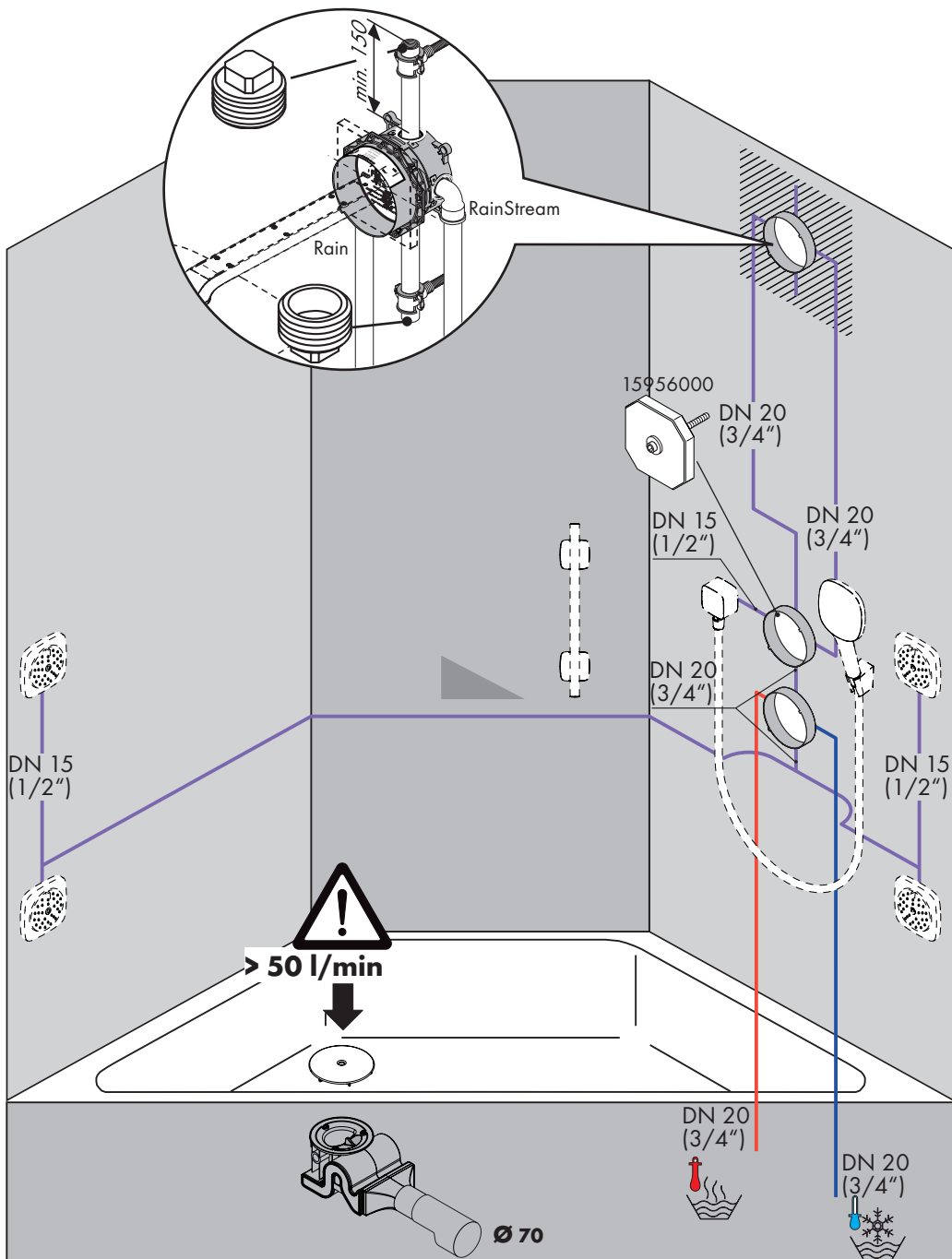

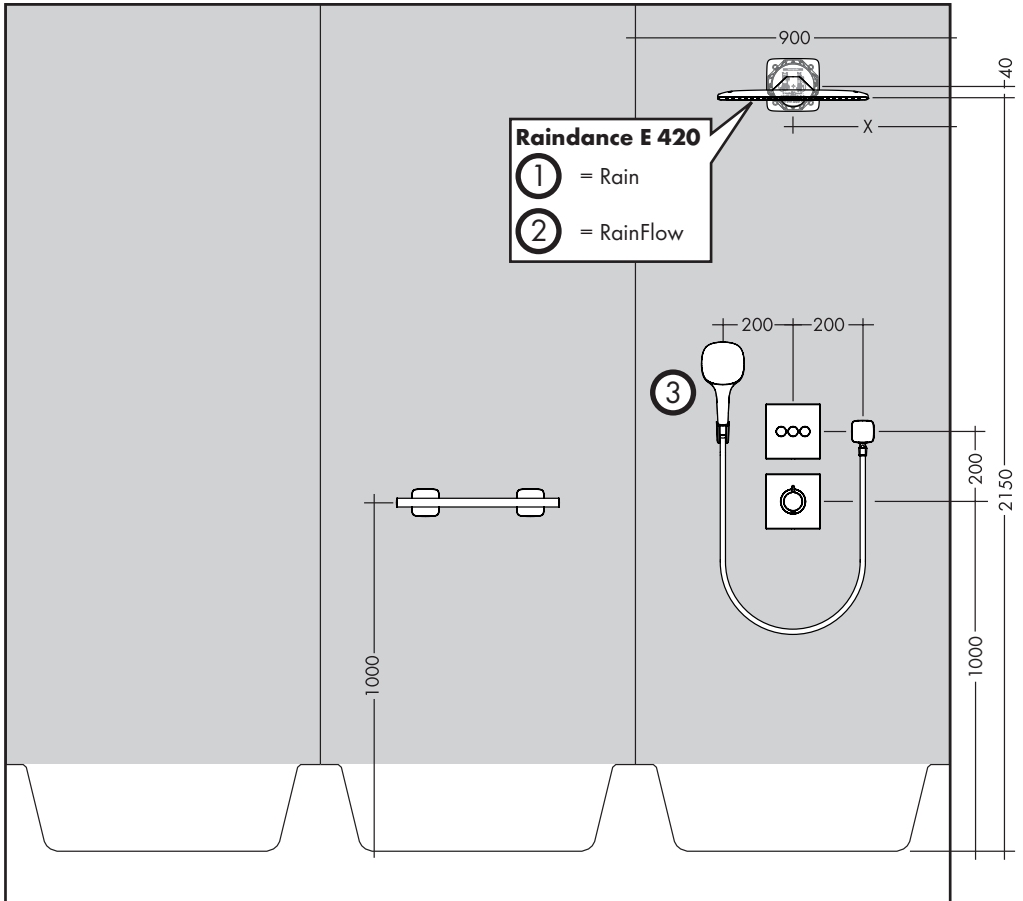
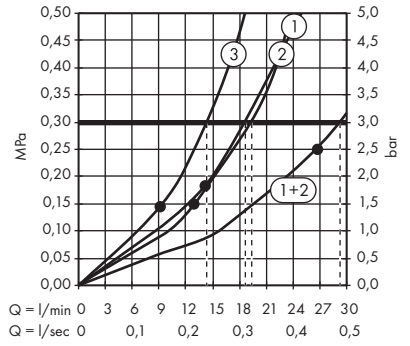
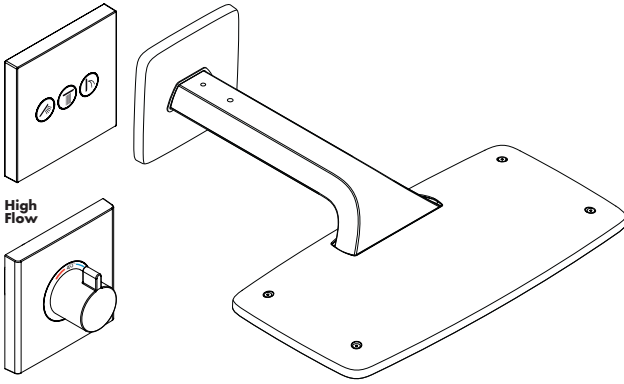

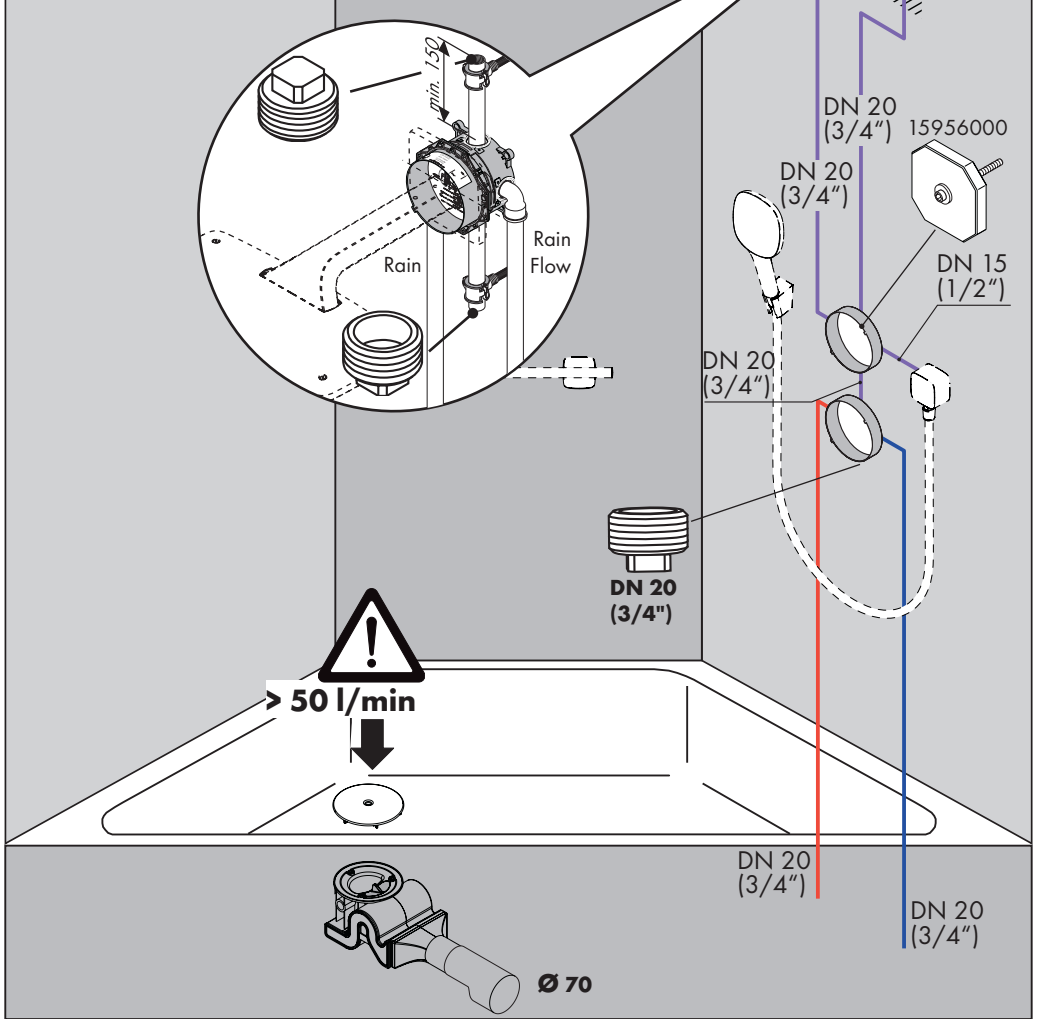
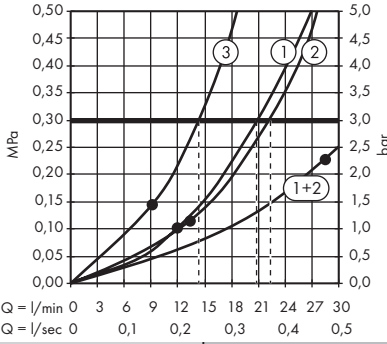
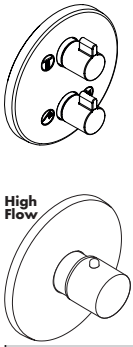

High Flow

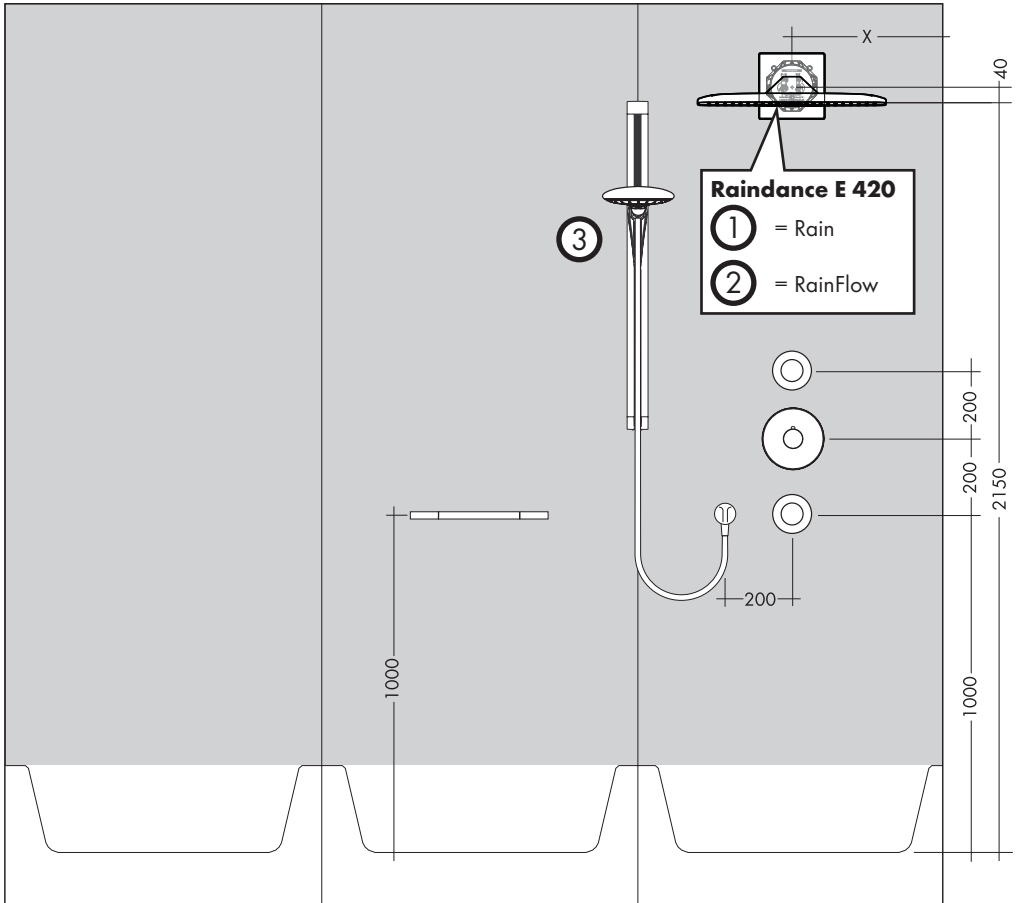
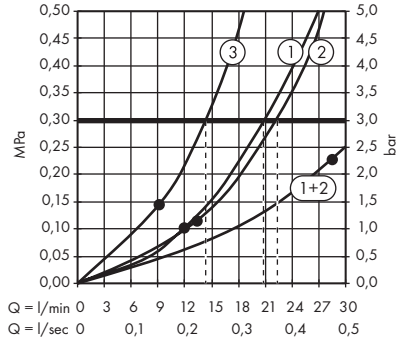
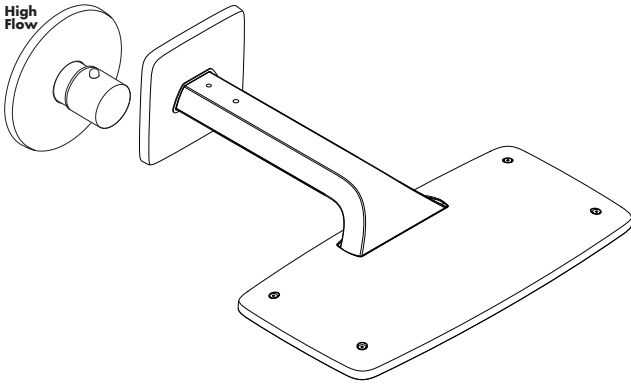

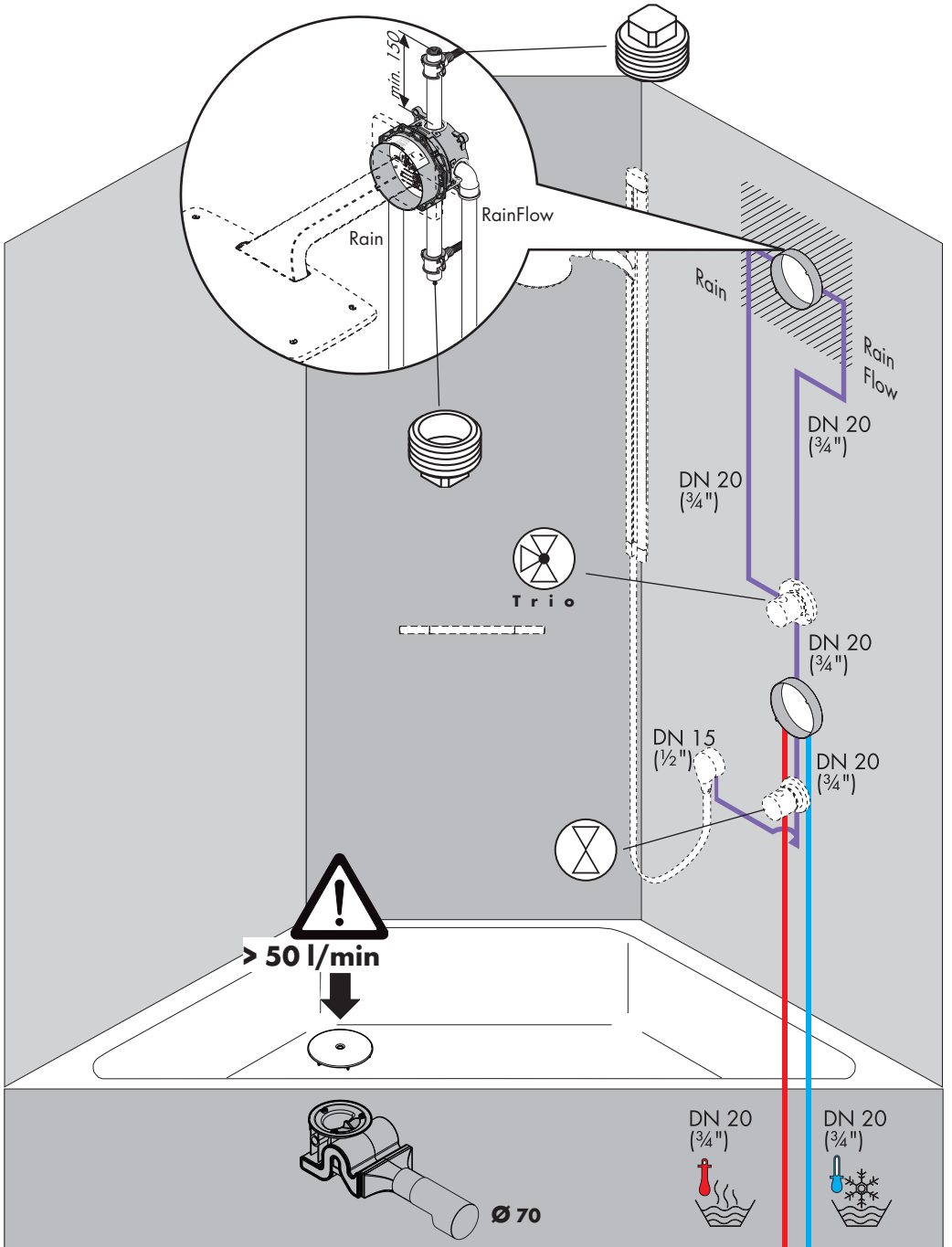

High Flow

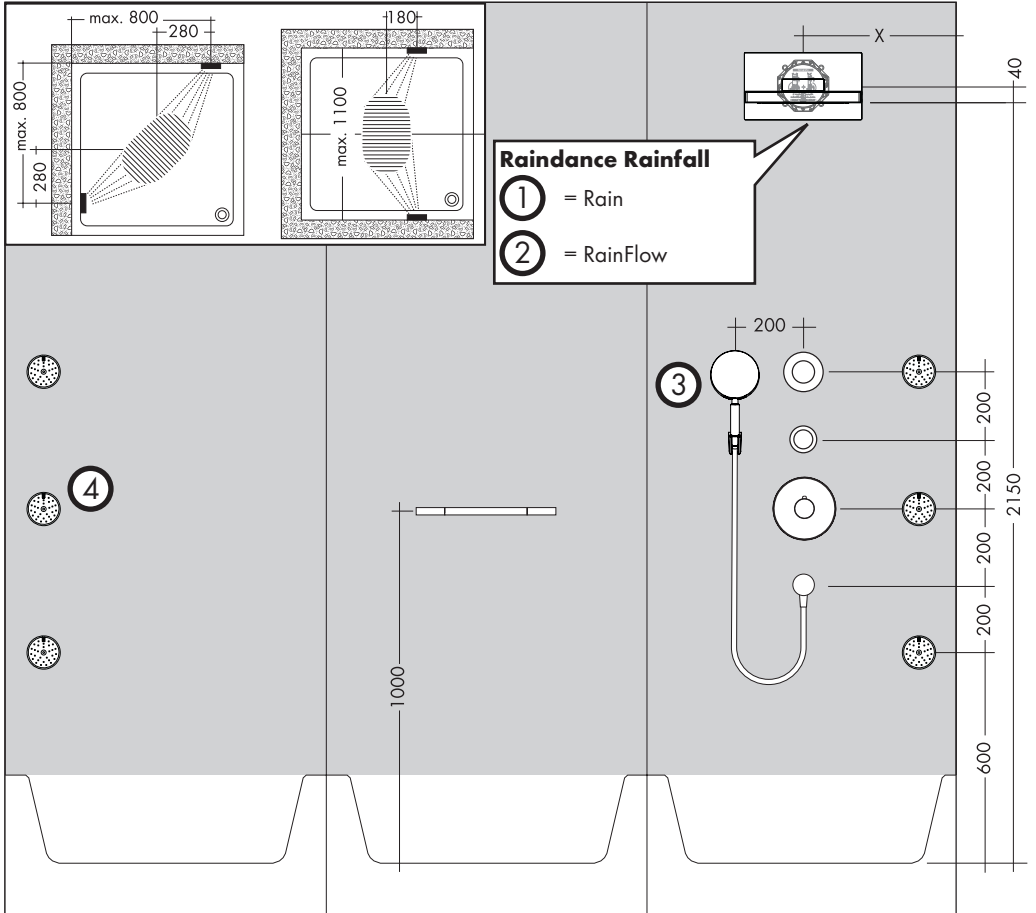
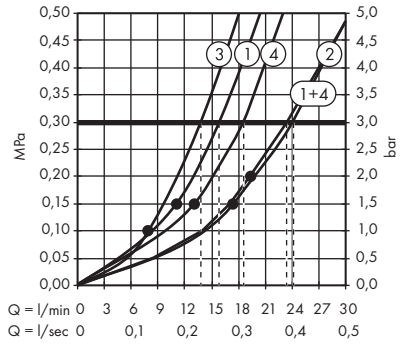
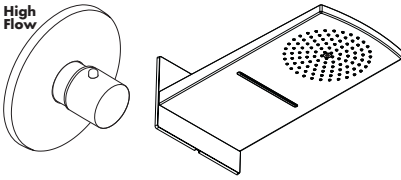

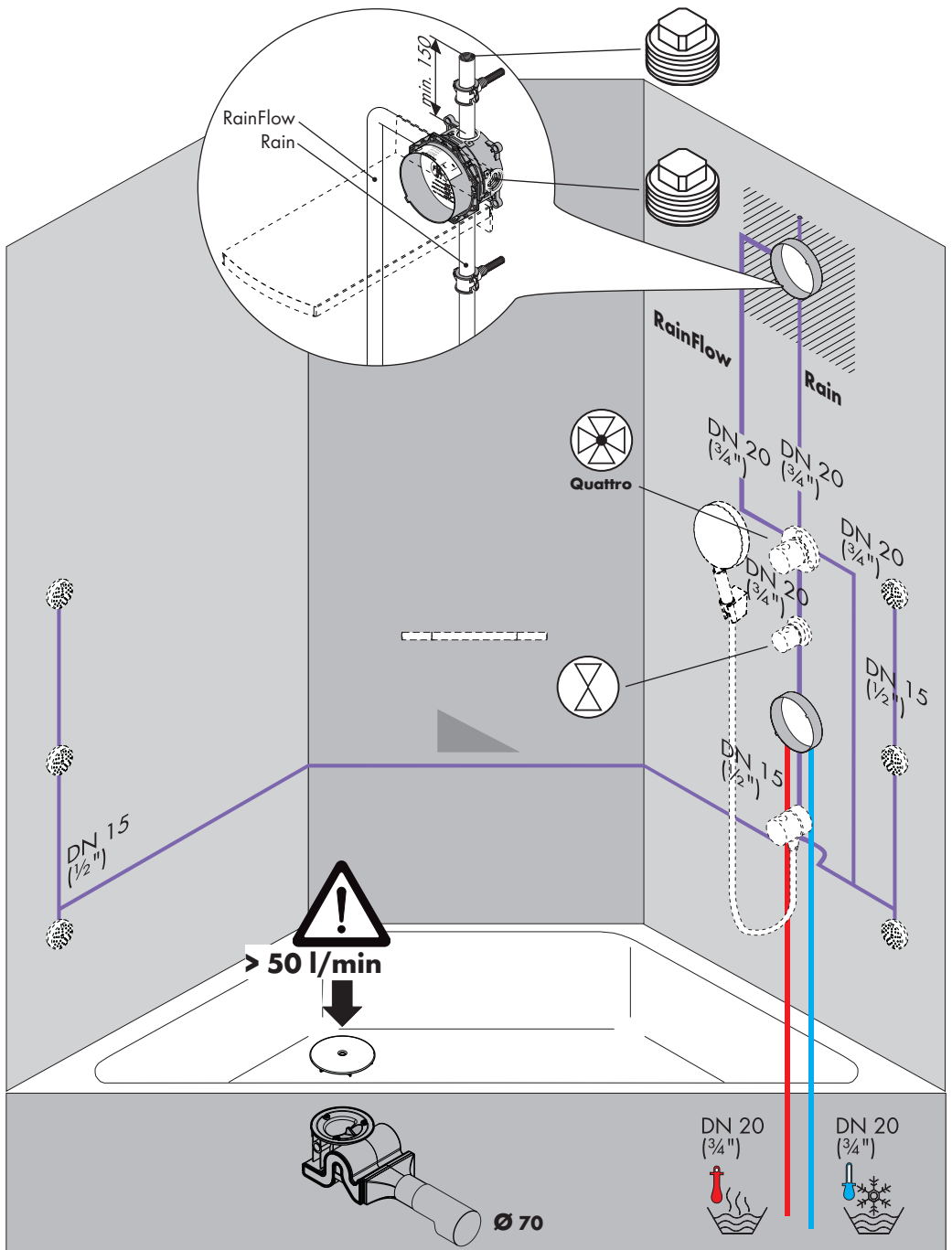

High Flow

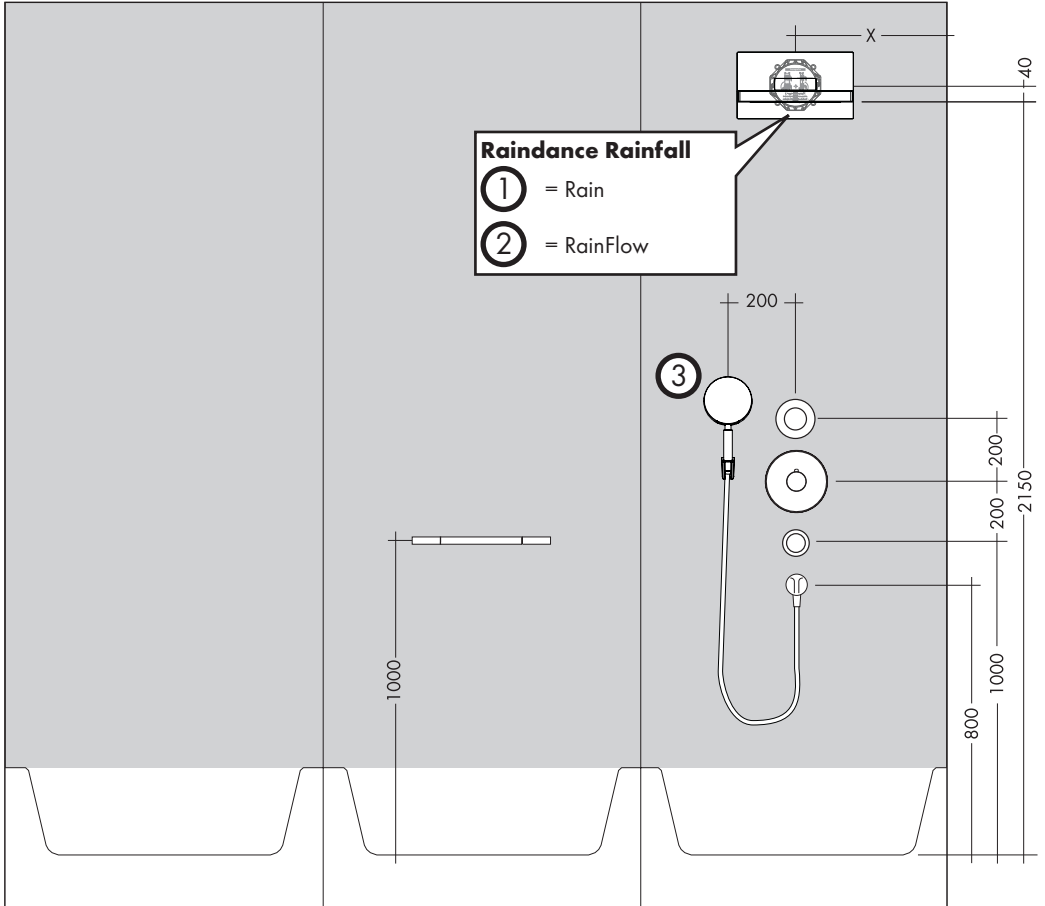
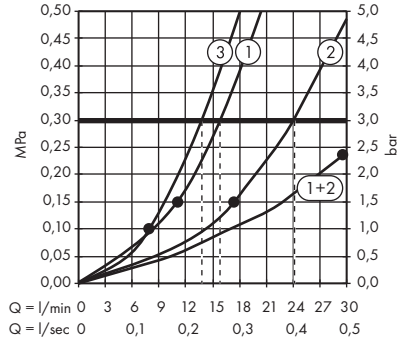
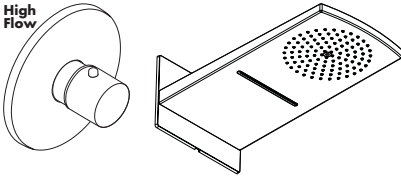

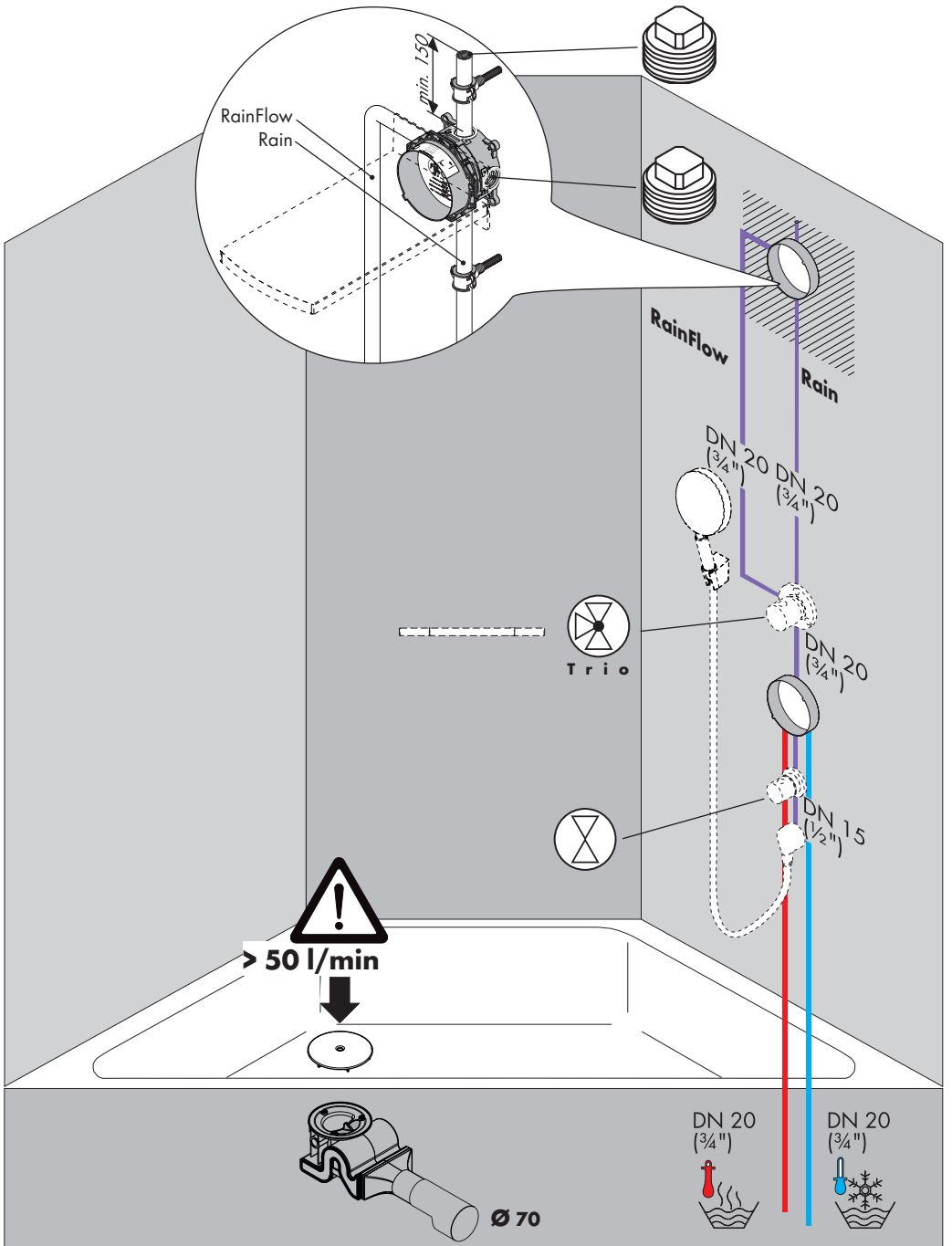

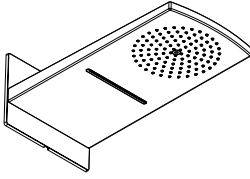
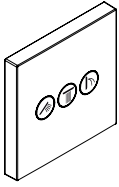

High Flow

