

PROGRAMMA MISCELAZIONE BAGNO  
BATH MIXING PROGRAM  
PROGRAMME DU MITIGEUR POUR LA SALLE DE BAIN  
BAD-MISCHUNGSPROGRAMM  
PROGRAMA MEZCLADORES BAÑO  
ПРОГРАММА СМЕСИТЕЛЕЙ ДЛЯ ВАННОЙ  
ΛΟΥΤΡΟ ΠΟΥ ΑΝΑΜΙΓΝΥΕΙ ΤΟ ΠΡΟΓΡΑΜΜΑ  
浴室混水产品

Art. 57002

Art. 57004

Art. 57006

Art. 57007

Art. 57010

Art. 57012

Art. 57016

Art. 57018

Art. 57871

Art. 57873

Art. 57875

Art. 57973

Art. 57975

**GESSI** 

**Gessi SpA** - Parco Gessi

13037 Serravalle Sesia (Vercelli) - Italy

Phone +39 0163 454111 - Facsimile +39 0163 459273

[www.gessi.com](http://www.gessi.com) - [gessi@gessi.it](mailto:gessi@gessi.it)

- AFILO -

Fig. 1

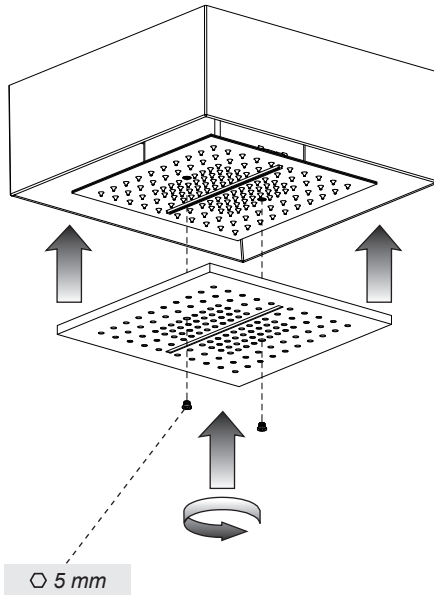
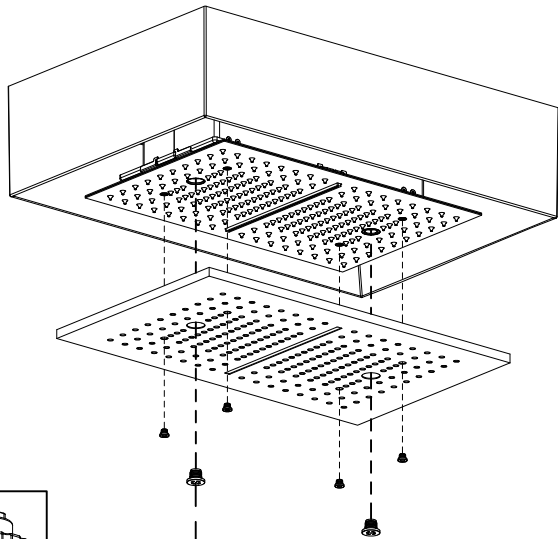

Fig. 2



Only for Art.  
57010-57016



Fornita in dotazione  
Supplied  
Fourni  
Mitgeliefert  
Incluido en el suministro  
Поставляется в комплекте  
Παρέχεται με τον εξοπλισμό  
包含于配件中

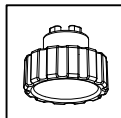

- MINIMALI -

Fig. 1

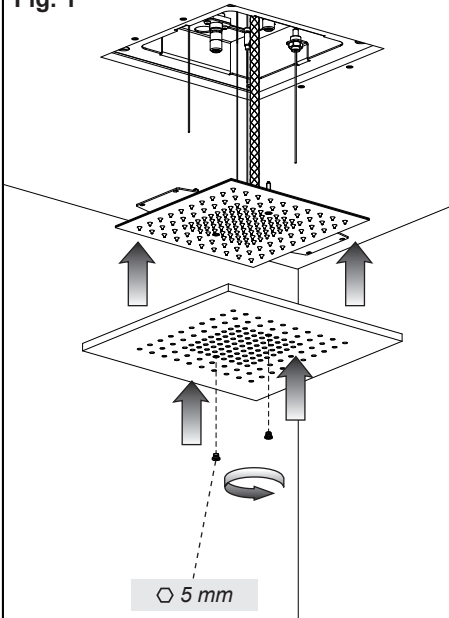

Fig. 2

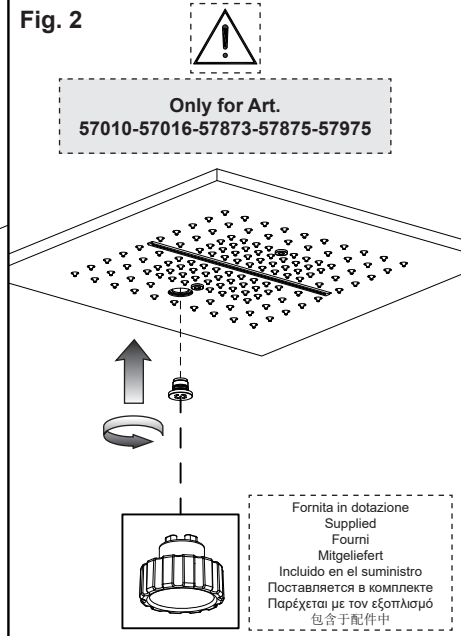
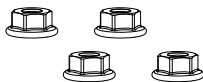
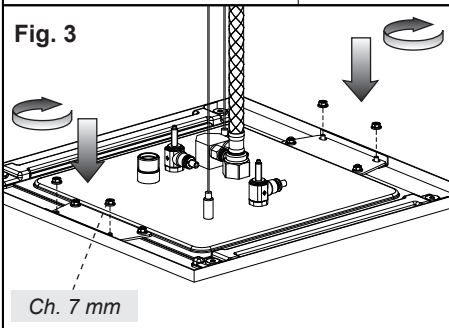
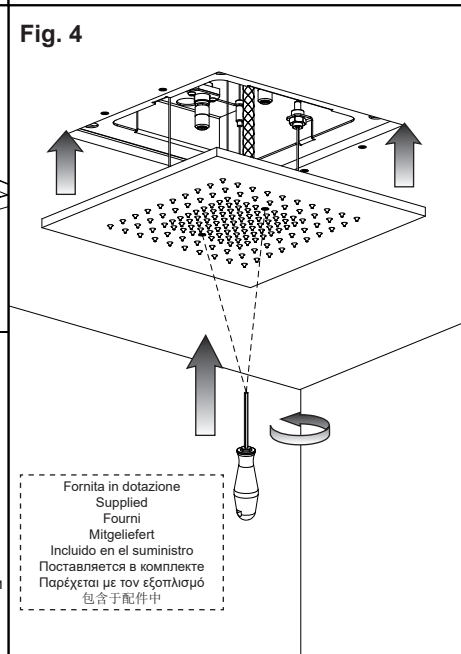

Fig. 3



In dotazione con la struttura del soffione  
 Supplied with the shower head structure  
 Fourni avec la structure de la pomme douche  
 Im Lieferumfang mit der Struktur des Brausekopfes enthalten  
 Incluido en el suministro con la estructura del rociador  
 Оно входит в комплект поставки вместе с структурой лейки  
 Παρέχεται με την δομή του φουσιήτρα  
 配备有吹管结构

Fig. 4



- MINIMALI -

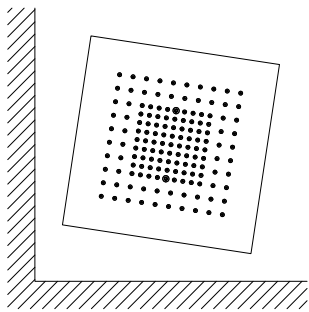

**NO!**

Fig. A

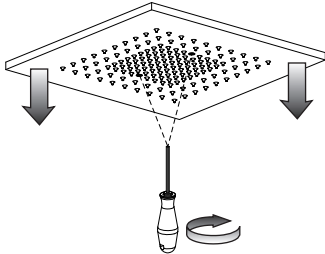

Fig. B

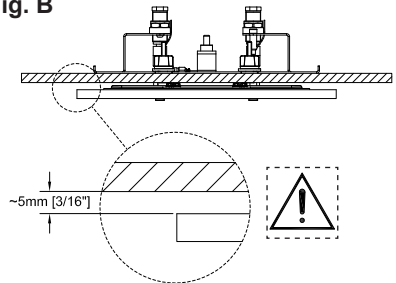

Fig. C

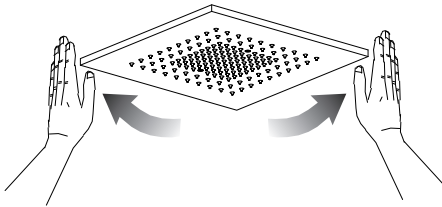
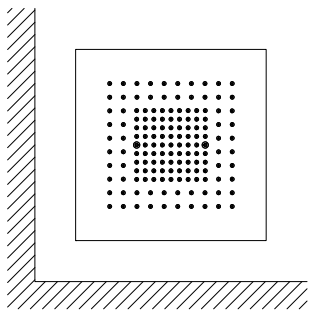
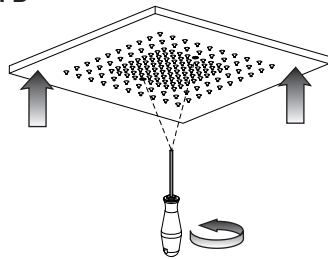

Fig. D



**OK!**