RESIDENCE

STONE
SOUL

FIVE
SIZES

4
COLORS

PORCELAIN STONEWARE

MADE IN ITALY



Design your life

Residence una texture essenziale
e moderna, in linea con le ultime
tendenze dell'architettura e
dell'interior design //
Ricca di dettagli porta il feeling
caldo della pietra in contesti
minimali contemporanei //

Residence an essential
and modern texture, in
line with the latest trends
in architecture and interior
design //
Featuring a wealth of details,
it brings the warmth of stone
to contemporary minimal
contexts //

Residence, une texture
essentielle et moderne, en
phase avec les dernières
tendances de l'architecture et
du design d'intérieur //
Riche en détails, elle insuffle
la sensation de chaleur de
la pierre dans des contextes
minimalistes contemporains //

Residence ist eine
essentielle und moderne
Textur, die den neuesten
Trends der Architektur und
des Interior Designs gerecht
wird //
Dank der reichhaltigen
Details erfüllt das Produkt
die kontemporären
minimalistischen Kontexte
mit dem warmen Gefühl von
Stein //

Коллекция Residence
предлагает строгую,
актуальную текстуру,
которая отвечает новейшим
тенденциям в сфере
архитектуры и дизайна
интерьеров //
Богатые детали ее
поверхности привносят
в современные
минималистские
пространства теплое
ощущение каменной отделки //

INTO THE SOUL
RESIDENCE

Il prestigio dei grandi formati è perfetto per esaltare gli spazi ampi mentre le misure più compatte e versatili valorizzano rivestimenti e ambienti residenziali // La presenza di superfici per interno ed esterno moltiplica la versatilità //

CREATIVE SURFACES

La fine texture, ispirata alle pietre sedimentarie, è ricca di dettagli con un raffinato amalgama di nuance naturali //
Le superfici posate offrono cromatismi caldi e moderni che aggiungono un tocco di naturalità alle linee essenziali dell'architettura contemporanea //

The fine texture, inspired by sedimentary stone, has a wealth of details with a refined amalgam of natural nuances. The laid surfaces offer warm and modern colours that bestow a touch of naturalness to the essential lines of contemporary architecture //

La fine texture, inspirée des pierres sédimentaires et riche en détails, est caractérisée par un mélange raffiné de nuances naturelles. Les surfaces, une fois posées, offrent des chromatismes chauds et modernes qui ajoutent une touche de nature aux lignes essentielles de l'architecture contemporaine //

Die feine, von den Sedimentsteinen inspirierte Textur ist reich an Details, mit einer raffinierten Mischung natürlicher Nuancen. Die verlegten Flächen bieten warme und moderne Farbeffekte, die den wesentlichen Linien der kontemporären Architektur einen Hauch von Natürlichkeit hinzufügen //

Богатая деталями, изящная текстура, воспроизводящая осадочные каменные породы, предлагает изысканную смесь природных оттенков. В результате укладки создаются поверхности с теплой, актуальной палитрой, придающие штрих естественности строгим линиям современной архитектуры //



RANGE
DETAILS

FIVE
SIZES

TWO
FINISHINGS

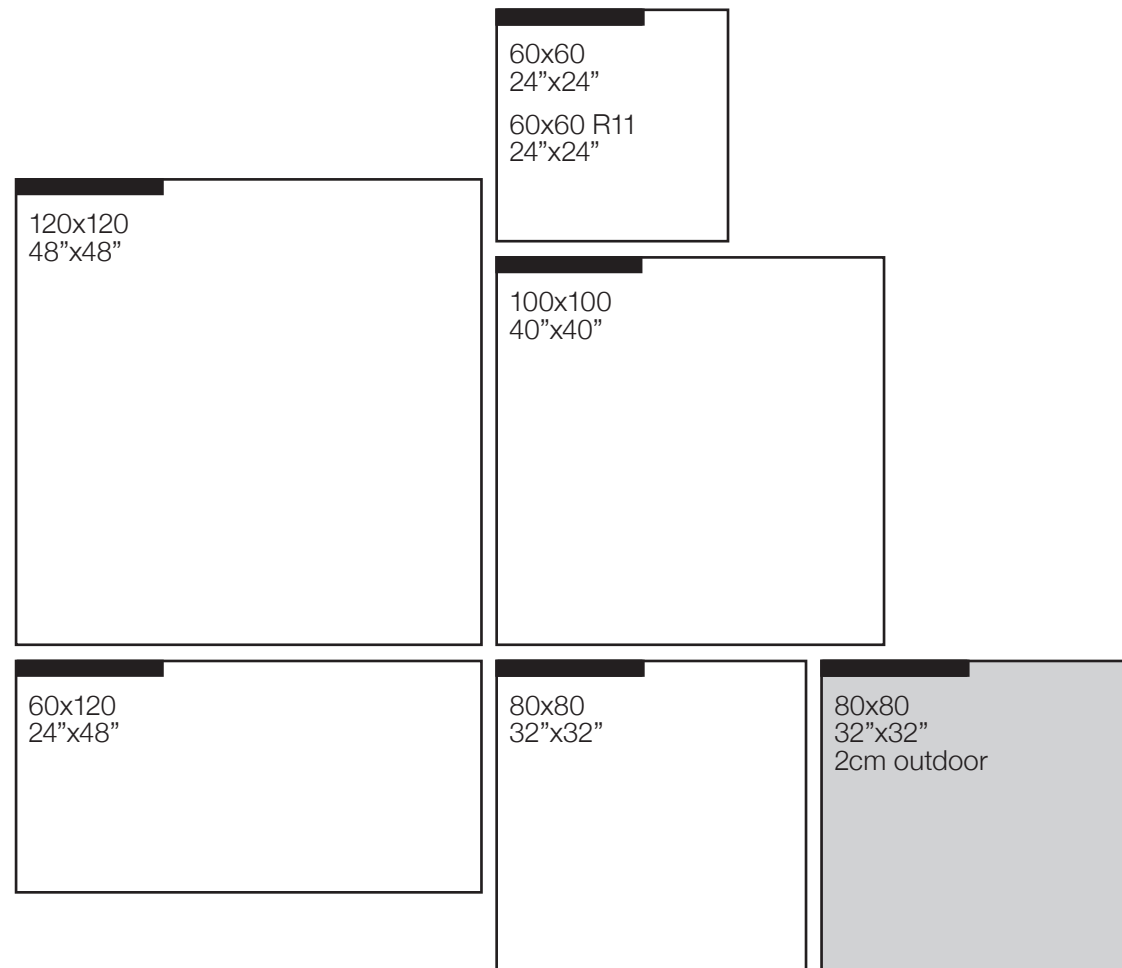

NATURALE

R11





8,5 mm
NAT



100x100

40"x40"

9,5 mm
NAT



120x120

48"x48"



60x120

24"x48"



80x80

32"x32"



60x60

24"x24"

9,5 mm
R11



60x60

24"x24"

20 mm
R11



80x80

32"x32"

	BEIGE	CREAM	GREIGE	GREY
8,5 mm NAT 100x100 40"x40"	✓	✓	✓	✓
9,5 mm NAT 120x120 48"x48"	✓	✓	✓	✓
60x120 24"x48"	✓	✓	✓	✓
80x80 32"x32"	✓	✓	✓	✓
60x60 24"x24"	✓	✓	✓	✓
9,5 mm R11 60x60 24"x24"	✓	✓	✓	✓
20 mm R11 80x80 32"x32"	✓	✓	✓	✓

APPLICATIONS
GALLERIES

A // HOME GALLERY



26 LIVING
BEIGE



30 BATHROOM
GREIGE



12 IN OUT
GREY

B // GARDEN GALLERY



24 SOLARIUM
BEIGE



20 POOL
CREAM

C // CONTRACT GALLERY



16 OUTDOOR
GREY

A // HOME IN OUT GREY

floor in
GREY 120x120 . 48"x48" RETT

floor out
GREY R11 60x60 . 24"x24" RETT

GREY PEZZI SPECIALI R11





floor in
GREY 120x120 . 48"x48" RETT

floor out
GREY R11 60x60 . 24"x24" RETT

Il pavimento del living
prosegue nell'area all'aperto
con la specifica finitura
antiscivolo R11 //
L'uniformità cromatica dilata e
raccorda gli spazi, creando un
tutt'uno inscindibile //

The living room floor
continues into the outdoor
area thanks to the specific
R11 anti-slip finish //
Chromatic uniformity
expands and connects
spaces, creating an
inseparable whole //

Le sol du living se poursuit
jusqu'à l'extérieur dans la
finition antidérapante R11
spécifique //
L'uniformité des couleurs
dilata et relie les espaces
en créant un ensemble
indissociable //

Der Boden des Wohnraums
setzt mit dem spezifischen
rutschfesten Finish R11 bis
in den Outdoor-Bereich fort //
Die chromatische
Gleichmäßigkeit erweitert
und verbindet die Bereiche
und bildet eine untrennbare
Einheit //

Напольное покрытие
гостиной продолжается
на улице благодаря
использованию материалов
со специальной
противоскользящей
отделкой R11 //
Цветовая однородность
расширяет и объединяет
пространства, превращая их
в единое целое //

C // CONTRACT OUTDOOR
GREY

wall
GREY 60x120 . 24"x48" RETT

floor
GREY R11 20MM 80x80 . 32"x32" RETT





floor
GREY R11 20MM 80x80 . 32"x32" RETT



B // GARDEN POOL CREAM

wall
CREAM 60x120 . 24"x48" RETT

floor
CREAM R11 20MM 80x80 . 32"x32" RETT
CREAM PEZZI SPECIALI R11

Lastre ad alto spessore per esterni pavimenti, pezzi speciali per bordo piscina e scale, rivestimenti di facciate e pareti: la gamma Residence offre le migliori soluzioni tecniche per dare sostanza e funzionalità al design: formati, finiture e accessori //

Ultra-thick large size tiles for outdoor floors, trim pieces for pool sides and stairs, façade and wall cladding: the Residence range offers the best technical solutions to give substance and functionality to the design: sizes, finishes and accessories //

Des dalles forte épaisseur pour sols extérieurs, des pièces spéciales pour bords de piscine et escaliers, des revêtements de façades et de murs : la gamme Residence, avec ses formats, ses finitions et ses accessoires, offre les meilleures solutions techniques pour donner substance et fonctionnalité au design //

Extradicke Platten für die Outdoor-Böden, Spezialteile für Schwimmbeckenränder und Treppen, Verkleidungen für Fassaden und Wände: Das Residence-Sortiment bietet die besten technischen Lösungen, um dem Design Substanz und Funktionalität zu verleihen: Formate, Finishes und Zubehör //

В ассортимент Residence входят многочисленные форматы, отделки и аксессуары, такие как плиты большой толщины для настила наружных полов, специальные изделия для оформления бортов бассейнов и лестниц, облицовки фасадов и стен. Это - наилучшие технические решения для наполнения дизайна содержанием и функциональностью //



floor
CREAM 60x120 . 24"x48" RETT





B // GARDEN SOLARIUM BEIGE

floor
BEIGE R11 20MM 80x80 . 32"x32" RETT
BEIGE PEZZI SPECIALI R11

Il gres porcellanato Cercom raggiunge i più elevati standard di qualità e durata // Non risente dell'esposizione al sole, al gelo e alle sostanze macchianti // E' prodotto in Italia, in modo responsabile e sostenibile //

Cercom porcelain stoneware reaches the highest standards of quality and durability // It is not affected by exposure to the sun, frost and staining substances // It is produced in Italy, in a responsible and sustainable manner //

Le grès cérame Cercom répond aux normes les plus strictes en matière de qualité et de durabilité // Il ne craint pas l'exposition au soleil, au gel et aux substances tachantes // Il est produit en Italie de manière responsable et durable //

Das Feinsteinzeug von Cercom erreicht die höchsten Qualitäts- und Dauerhaftigkeitsstandards // Es leidet nicht unter der Exposition gegenüber Sonnenstrahlen, Frost und fleckenbildenden Substanzen // Es wird in verantwortlicher und nachhaltiger Weise in Italien hergestellt //

Керамогранит Cercom обеспечивает высочайшие стандарты качества и долговечности // Он устойчив к воздействию солнечного излучения, мороза и красящих веществ // Кроме того, он выпускается в Италии ответственным и экологичным способом //

A // HOME LIVING
BEIGE

floor
BEIGE 100x100 . 40"x40" RETT





floor
BEIGE 60x120 . 24"x48" RETT

wall
BEIGE MOSAICO ESAGONA 25x30 . 10"x12" RETT



A // HOME BATHROOM GREIGE

wall
GREIGE 60x120 . 24"x48" RETT

floor in
GREIGE 60x120 . 24"x48" RETT

floor out
GREIGE R11 20MM 80x80 . 32"x32" RETT

Le quattro colorazioni si declinano con coerenza e stile nel mondo dei toni neutri, caldi e naturali // L'interior design contemporaneo trova la nuance ideale e una perfetta continuità tra pavimento, pareti, interno ed esterno //

The four colours are articulated with coherence and style in the world of neutral, warm and natural tones // Contemporary interior design finds the ideal nuance and perfect continuity between floor, walls, indoor and outdoor //

Les quatre couleurs se déclinent avec cohérence et style dans l'univers des nuances neutres, chaudes et naturelles // Le design d'intérieur contemporain trouve la nuance idéale ainsi qu'une continuité parfaite entre sol, murs, intérieur et extérieur //

Die vier Farben fügen sich kohärent und stilvoll in die Welt der warmen und natürlichen Neutraltöne // Das kontemporäre Interior Design findet die ideale Nuance und eine perfekte Kontinuität zwischen Boden und Wänden, innen und außen //

Четыре цвета коллекции последовательно и элегантно вписываются в палитру нейтральных, теплых и натуральных тонов. Таким образом, современный дизайн интерьера приобретает идеальные оттенки и безупречную согласованность для оформления полов, стен, интерьеров и экстерьеров //



floor
GREIGE 100x100 . 40"x40" RETT



BEIGE



GRES PORCELLANATO SMALTATO COLORATO IN MASSA . GLAZED PORCELAIN STONWARE WITH COLOURED BODY . GRÈS CÉRAME ÉMAILLÉ COLORÉ DANS LA MASSE
GLASIERTES FEINSTEINZEUG IN DER MASSE GEFÄRBT . ГЛАЗУРОВАННЫЙ КЕРАМОГРАНИТ, ОКРАШЕННЫЙ ПО ВСЕЙ ТООЛЩИНЕ



Sizes	NAT	R11
8,5 MM 5/16" 100x100 . 40"x40" RETT	□	
9,5 MM 3/8" 120x120 . 48"x48" RETT	□	
60x120 . 24"x48" RETT	□	
80x80 . 32"x32" RETT	□	
60x60 . 24"x24" RETT	□	□
2 CM 13/16" 80x80 . 32"x32" RETT		□

Mosaics	NAT
9,5 MM 3/8" Mosaico Tessera 5x5 . 2"x2" 30x30 . 12"x12" RETT	□
Mosaico Esagona 25x30 . 10"x12" RETT	□

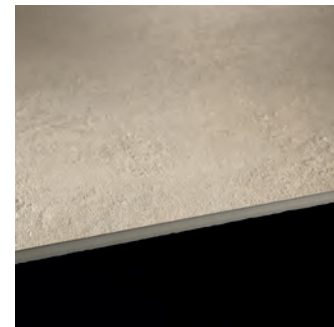

NAT
RETT



R11
R11 RETT

Pezzi speciali . Special pieces . Pièces spéciales
Formteile . Специальные элементы: Pag. 39

CREAM



GRES PORCELLANATO SMALTATO COLORATO IN MASSA . GLAZED PORCELAIN STONWARE WITH COLOURED BODY . GRÈS CÉRAME ÉMAILLÉ COLORÉ DANS LA MASSE
GLASIERTES FEINSTEINZEUG IN DER MASSE GEFÄRBT . ГЛАЗУРОВАННЫЙ КЕРАМОГРАНИТ, ОКРАШЕННЫЙ ПО ВСЕЙ ТООЛЩИНЕ



Sizes	NAT	R11
8,5 MM 5/16" 100x100 . 40"x40" RETT	□	
9,5 MM 3/8" 120x120 . 48"x48" RETT	□	
60x120 . 24"x48" RETT	□	
80x80 . 32"x32" RETT	□	
60x60 . 24"x24" RETT	□	□
2 CM 13/16" 80x80 . 32"x32" RETT		□

Mosaics	NAT
9,5 MM 3/8" Mosaico Tessera 5x5 . 2"x2" 30x30 . 12"x12" RETT	□
Mosaico Esagona 25x30 . 10"x12" RETT	□



NAT
RETT

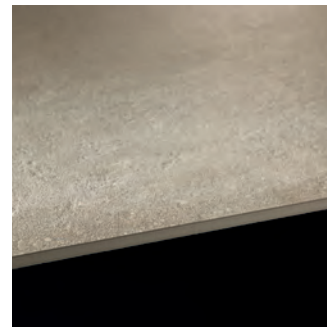

R11
R11 RETT

Pezzi speciali . Special pieces . Pièces spéciales
Formteile . Специальные элементы: Pag. 39

GREIGE



GRES PORCELLANATO SMALTATO COLORATO IN MASSA . GLAZED PORCELAIN STONEWARE WITH COLOURED BODY . GRÈS CÉRAME ÉMAILLÉ COLORÉ DANS LA MASSE
GLASIERTES FEINSTEINZEUG IN DER MASSE GEFÄRBT . ГЛАЗУРОВАННЫЙ КЕРАМОГРАНИТ, ОКРАШЕННЫЙ ПО ВСЕЙ ТООЛЩИНЕ



Sizes	NAT	R11
8,5 MM 5/16" 100x100 . 40"x40" RETT	□	
9,5 MM 3/8" 120x120 . 48"x48" RETT	□	
60x120 . 24"x48" RETT	□	
80x80 . 32"x32" RETT	□	
60x60 . 24"x24" RETT	□	□
2 CM 13/16" 80x80 . 32"x32" RETT		□

Mosaics	NAT
9,5 MM 3/8" Mosaico Tessera 5x5 . 2"x2" 30x30 . 12"x12" RETT	□
Mosaico Esagona 25x30 . 10"x12" RETT	□



NAT
RETT



R11
R11 RETT

Pezzi speciali . Special pieces . Pièces spéciales
Formteile . Специальные элементы: Pag. 39

GREY



GRES PORCELLANATO SMALTATO COLORATO IN MASSA . GLAZED PORCELAIN STONEWARE WITH COLOURED BODY . GRÈS CÉRAME ÉMAILLÉ COLORÉ DANS LA MASSE
GLASIERTES FEINSTEINZEUG IN DER MASSE GEFÄRBT . ГЛАЗУРОВАННЫЙ КЕРАМОГРАНИТ, ОКРАШЕННЫЙ ПО ВСЕЙ ТООЛЩИНЕ



Sizes	NAT	R11
8,5 MM 5/16" 100x100 . 40"x40" RETT	□	
9,5 MM 3/8" 120x120 . 48"x48" RETT	□	
60x120 . 24"x48" RETT	□	
80x80 . 32"x32" RETT	□	
60x60 . 24"x24" RETT	□	□
2 CM 13/16" 80x80 . 32"x32" RETT		□

Mosaics	NAT
9,5 MM 3/8" Mosaico Tessera 5x5 . 2"x2" 30x30 . 12"x12" RETT	□
Mosaico Esagona 25x30 . 10"x12" RETT	□



NAT
RETT



R11
R11 RETT

Pezzi speciali . Special pieces . Pièces spéciales
Formteile . Специальные элементы: Pag. 39

MOSAICI

MOSAICS . MOSAÏQUES . MOSAIKEN . МОЗАИКА



MOSAICO TESSERA



BEIGE
30x30 . 12"x12" RETT
tessera 5x5 . 2"x2"



CREAM
30x30 . 12"x12" RETT
tessera 5x5 . 2"x2"



GREIGE
30x30 . 12"x12" RETT
tessera 5x5 . 2"x2"



GREY
30x30 . 12"x12" RETT
tessera 5x5 . 2"x2"

MOSAICO ESAGONA



BEIGE
25x30 . 10"x12" RETT



CREAM
25x30 . 10"x12" RETT



GREIGE
25x30 . 10"x12" RETT



GREY
25x30 . 10"x12" RETT

PEZZI SPECIALI

TRIMS . PIÈCES SPÉCIALES . FORMSTÜCKE . СПЕЦИАЛЬНЫЕ ИЗДЕЛИЯ



Battiscopa
6,5x100 . 2 9/16"x40" RETT



Battiscopa
7,5x80 . 3"x32" RETT

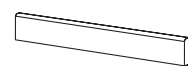

Battiscopa
6,5x60 . 2 9/16"x24" RETT

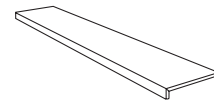

Gradone costa retta
30x120x3,3 . 12"x48"x1 5/16" RETT

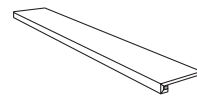

Gradone square assembled
30x120x3,3 . 12"x48"x1 5/16" RETT

PEZZI SPECIALI

TRIMS . PIÈCES SPÉCIALES . FORMSTÜCKE . СПЕЦИАЛЬНЫЕ ИЗДЕЛИЯ

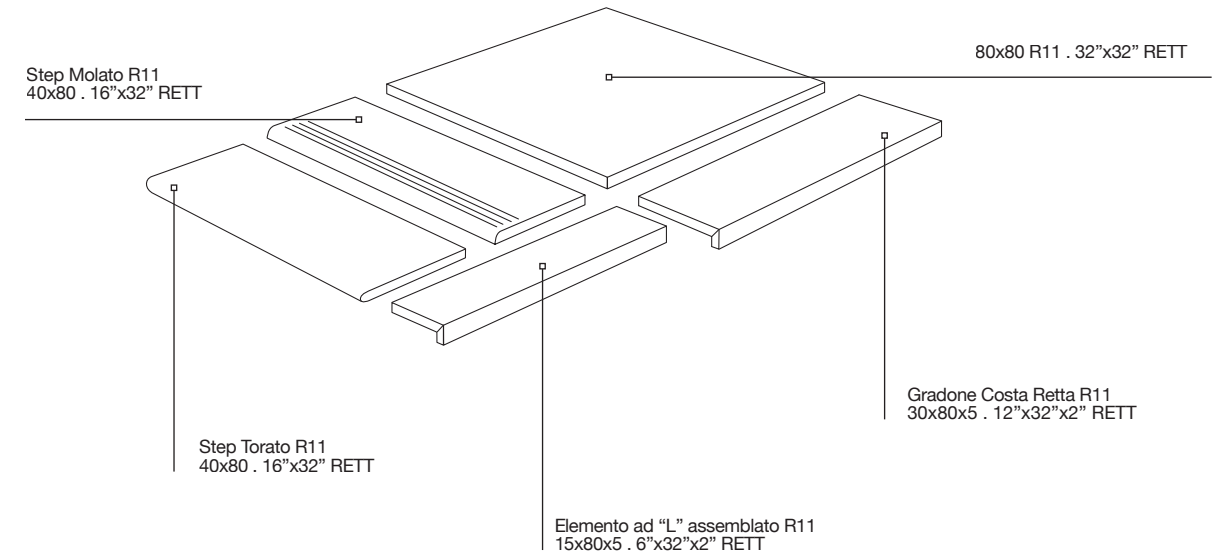

PACKING











	PCS // BOX	SQM // BOX	KGS // BOX	BOXES // PALLET	SQM // PALLET	KGS // PALLET
8,5 MM 5/16"						
100x100 . 40"x40" RETT	2	2,00	38,00	24	48,00	950
9,5 MM 3/8"						
120x120 . 48"x48" RETT	1	1,44	31,00	40	57,60	1300
60x120 . 24"x48" RETT	2	1,44	31,00	36	51,84	1144
80x80 . 32"x32" RETT	1	1,28	27,50	48	61,44	1340
60x60 . 24"x24" RETT / R11 RETT	3	1,08	22,80	40	43,20	928
2 CM 13/16"						
80x80 . 32"x32" RETT	1	0,64	30,50	48	30,70	1484

CARATTERISTICHE TECNICHE

TECHNICAL FEATURES . CARACTÉRISTIQUES TECHNIQUES . TECHNISCHE EIGENSCHAFTEN . ТЕХНИЧЕСКИЕ ХАРАКТЕРИСТИКИ

// ufoadv.com

GRES PORCELLANATO SMALTATO COLORATO IN MASSA - ISO 13006 BIa GL GLAZED PORCELAIN STONEWARE WITH COLOURED BODY . GRÈS CÉRAME ÉMAILLÉ COLORÉ DANS LA MASSE GLASIERTES FEINSTEINZEUG IN DER MASSE GEFÄRBT . ГЛАЗУРОВАННЫЙ КЕРАМОГРАНИТ, ОКРАШЕННЫЙ ПО ВСЕЙ ТООЛЩИНЕ

	Aspetto superficiale Surface appearance Aspect superficiel Oberflächenbeschaffenheit Вид поверхности	≥ 95%	Conforme Compliant Conforme Konform Соответствует
	Lunghezza e larghezza Length and width Longueur et largeur Länge und Breite Длина и ширина	Deviazione valore medio % rispetto a dimensione di fabbricazione. Deviation of the average size for each tile from the work size (%). Écart dimensionnel moyen en % par rapport aux dimensions de fabrication. Abweichung des Durchschnittswertes in % hinsichtlich der Produktionsgröße. Отклонение средн. значения, %, от производственных размеров > 410 cm2 +/- 0,6% - ≤ 410 cm2 +/- 0,75%	± 0,5% ± 1,5 mm
	Rettilinearità degli spigoli Straightness of sides Rectitude des arêtes Kantengeradheit Прямолнейность кромок	Deviazione valore medio % rispetto a dimensione di fabbricazione. Deviation of the average size for each tile from the average size to the 10 test specimens (%). Écart de valeur moyenne unitaire % en rapport à la valeur moyenne de 10 échantillons mesurés. Abweichung des Durchschnittswertes der einzelnen Fliesen in % hinsichtlich des Durchschnitts von 10 getesteten Mustern. Отклонение средн. значения, отдельной плитки относительно средн. значения 10 измеренных образцов +/- 0,5%	± 0,5% ± 1,5 mm
	Spessore / Thickness / Epaisseur/Stärke / Толщина	+/- 5%	± 5% ± 0,5 mm
	Ortogonalità Rectangularity Orthogonalité Rechtwinkligkeit Ортогональность	+/- 0,5%	± 0,3% ± 1,5 mm
	Planarità Surface flatness Planéité Ebenflächigkeit Плоскостность	+/- 0,5%	± 0,5% ± 1,5 mm
	Assorbimento d'acqua Water absorption Absorption d'eau Wasseraufnahme Водопоглощение	≤ 0,5% GRUPPO BIa GL	E ≤ 0,1%
	Resistenza della superficie (scala MOHS) Scratch hardness (MOHS scale) Dureté de la surface (échelle MOHS) Oberflächenhärte (MOHS skala) Поверхностная прочность по (шкале Мооса)	EN 101	> 6
	Resistenza a flessione e forza di rottura Modulus of rupture and breaking strength résistance à la flexion et force de rupture Biegefestigkeit und Bruchlast Прочность на изгиб Модуль жесткости	S ≥ 1300 N R ≥ 35 N/mm2	S ≥ 1300 N R ≥ 35 N/mm²
	Resistenza alla abrasione della superficie di piastrelle smaltate Resistance to surface abrasion of glazed tiles Résistance à l'abrasion de la surface des carreaux émaillés Widerstand gegen Abrieb der Oberfläche der glasierten Fliesen Стойкость глазурованной плитки к поверхностному истиранию	Come dichiarato dal produttore See manufacturer's declaration Selon déclaration du producteur Entsprechend der Herstellerangaben Как указано изготовителем	Classe 3-4 Class 3-4 Classe 3-4 Gruppe 3-4 Класс 3-4
	Coefficiente di dilatazione termica lineare Linear thermal expansion coefficient Dilatation thermique linéaire Lineare Wärmeausdehnung Кэффициент линейного теплового расширения	Come dichiarato dal produttore See manufacturer's declaration Selon déclaration du producteur Entsprechend der Herstellerangaben Как указано изготовителем	Metodo disponibile Method available Méthode disponible Verfügbares verfahren Определяется производителем
	Resistenza allo shock termico Thermal shock resistance Résistance au choc thermique Temperaturwechselbeständigkeit Стойкость к тепловым перепадам	Nessun campione deve presentare alterazioni No sample must show visible alteration Aucun carreau ne doit présenter d'altération Kein Muster darf sichtbare Veränderungen zeigen Никакой образец не должен показывать изменений	Resistente Resistant Résistant Widerstandsfähig Устойчивый
	Resistenza al gelo Frost resistance Résistance au gel Frostbeständigkeit Морозостойкость	Non devono presentare difetti visibili No sample must show visible defect Aucun carreau ne doit présenter de défaut Muster dürfen keine sichtbaren Schäden zeigen Не должны обнаруживать видимые дефекты	Ingelivo Frost proof Ingelif Frostsicher Морозостойкость
	Resistenza all'attacco chimico (tranne acido fluoridrico) Resistance to chemical attack (except hydrofluoric acid) Résistance à l'attaque chimique (sauf acide fluorhydrique) Säure- und Laugenbeständigkeit (außer Flußsäure) Стойкость к бытовым химикатам	Nessun campione deve presentare alterazioni No sample must show visible alteration Aucun carreau ne doit présenter d'altération Muster dürfen keine sichtbaren Veränderungen zeigen Никакой образец не должен показывать изменений	Classe A-HA-LA Class A-HA-LA Classe A-HA-LA Gruppe A-HA-LA Класс A-HA-LA
	Resistenza alle macchie di piastrelle smaltate Resistance to stains of glazed tiles Résistance aux taches des carreaux émaillés Widerstand gegen Fleckenbildner der glasierten Fliesen Стойкость глазурованной плитки к образованию пятен	Nessun campione deve presentare alterazioni No sample must show visible alteration Aucun carreau ne doit présenter d'altération Muster dürfen keine sichtbaren Veränderungen zeigen Никакой образец не должен показывать изменений	Classe 5 Class 5 Classe 5 Gruppe 5 Класс 5
	Resistenza alla scivolosità. Coefficiente di attrito medio Skid resistance. Average coefficient of friction Résistance au glissement. Coefficient de frottement moyen Rutschfestigkeit. Mittlerer Reibungswert Сопротивление скольжению. Средний коэффициент трения	B.C.R.A. REP. CEC. 6/81 DIN 51130 ≥ R 9 DIN 51097	f ^h ≥ 0,40 R10 R11 Classe B Classe C C C C C Class B Class C C C C C Classe B Classe C C C C C Gruppe B Gruppe C C C C C Класс B Класс C C C C C
	DCOF	f ^h > 0,42	



TILES FOR LIFE



Design your life

Via A. Volta 23/25 - 42013 Casalgrande (Re) Italy
Tel. +39-0522-998911/411



© Copyright 2024 Gruppo Romani S.p.A.

Gruppo Romani S.p.A. Industrie Ceramiche
www.grupporomanispa.com



RESIDENCE

#SIZE

120x120
48"x48"

60x120
24"x48"

100x100
40"x40"

80x80
32"x32"

60x60
24"x24"

#COLORS

CREAM

GREY

GREIGE

BEIGE

#SURFACES

NAT

R11

Cercom is a brand of

 **GRUPPO
ROMANI**
INDUSTRIE CERAMICHE SPA